

Laparoscopy Endoscopy



**Advanced
instruments
for laparoscopic
surgery**



Laparoscopy Endoscopy

**For more than 55 years:
Quality and Safety**

Know How and Innovation
Technology and Precision
Service and Flexibility

Quality Management:

Certified according to:
ISO 13485;
Annex II, section 3 of the
directive 93/42/EEC

Our Products:

Instruments for MIS
(Laparoscopy, Hysteroscopy,
Arthroscopy, Urology)

Endoscopy units

Electrosurgery and
accessories

Plastic surgery

Titanium-implant-systems
for maxillo-facial as well as
hand- and radius surgery,
mandibular reconstruction

Scissors and micro-scissors,
also with TC-inserts or
"super cut"

Instruments for general
surgery



Inhaltsverzeichnis

Laparoskopie	Seite
Allgemeine Informationen	4
Aufbau der Artikelnummern und Einzelteile.....	8
Behälter	59
Biopsiezangen	26
Bipolare Anschlußkabel	53/54
Bipolare Haken und Nadeln	54
Bipolare Koagulations- elektroden	53/54
Bipolare Koagulationsgriffe	52/54
Cholangiogramm- Fixierzange	44
Clipanlegezangen	35
Dichtungen	8/42
Faßzangen	14-25
Fascia-Nähhilfe	44
Griffe	9
Hasson-Konus	41
Insufflationskanülen	43
Klemmen.....	28
Knotenführer.....	44
Laparoskope	55
Leberelevator	44
Lichtleitkabel	55
Monopolarelektroden	47/48
Monopolarsauger.....	48
Monopolare Anschlußkabel	49
Nadelhalter mit Hartmetall	32/34
Nadelhalter ohne Hartmetall	32
Reduzierer	41
Reinigung und Pflege	58
Saug- Spülsysteme.....	45
Schäfte für Scheren / Zangen.....	8
Schäfte für Trokare	37/39
Scheren mit Hartmetall	12
Scheren ohne Hartmetall	10
Stanzen	30
Trokare.....	40
Trokarhülsen	36
Wasserstrahl- reinigungspistole.....	58
Zerlegen des Instruments	6
Zubehör	50

Endoskopie

Flexible Biopsie-Zangen	56
Flexible Faßzangen	57

Table of Contents

Laparoscopy	Page
Accessories.....	50
Biopsy Forceps	26
Bipolar Coagulation Cables	53/54
Bipolar Coagulation Electrodes.....	53/54
Bipolar Coagulation Handle	52/54
Bipolar Hooks and Needles.....	54
Cholangiogram Fixation Clamp.....	44
Clamps.....	28
Cleaning and Care.....	58
Clip Applying Forceps	35
Cold Light Cable.....	55
Detachment of the Instruments.....	6
Fan Retractor.....	44
Fascia closure device	44
General Information	4
Grasping Forceps.....	14-25
Handles	9
Hasson-Conus	41
High Frequency Cables.....	56
Insufflation Needles.....	43
Knot pusher	44
Laparoscopes	55
Monopolar connecting cables.....	49
Monopolar Electrodes.....	47/48
Monopolar Suction Units.....	48
Needle Holders with Tungsten Carbide	32/34
Needle Holders without Tungsten Carbide	32
Punches.....	30
Reducers.....	41
Scissors with Tungsten Carbide	12
Scissors without Tungsten Carbide	10
Sealings	8/42
Shafts for Scissors / Forceps.....	8
Shafts for Trocars.....	37/39
Suction- Irrigation Systems.....	45
Structure Article Numbers and Components.....	8
Trays	59
Trocars.....	40
Trocar Sleeves	36
Water Jet Cleaning Pistol.....	58

Endoscopy

Flexible Biopsy Forceps	56
Flexible Grasping Forceps.....	57

Allgemeine Informationen

General Information



Drehbare/Zerlegbare Instrumente

(Anleitung auf Seite 6)

Wir haben eine Serie von drehbaren/zerlegbaren Instrumenten entwickelt um die Reinigung der Laparoskopie-Instrumente zu optimieren.

Die Instrumente können zum Sterilisieren in zwei (bei Ø 3 mm-Serie) bzw. drei (bei Ø 5+10 mm-Serie) Einzelteile zerlegt werden. Durch den praktischen Kompakt-Griff bleibt dieser komplett bestehen, d. h. er muß nicht weiter zerlegt werden. Alle Einzelteile sind untereinander kompatibel. Daher wird ein problemloses Wiederezusammenfügen garantiert.

Darüberhinaus läßt sich der Schaft der Instrumente um 360° drehen. Die ergonomisch gestaltete Lamellen-Schraube unterstützt ein müheloses Drehen und damit das ermüdungsfreie Arbeiten des Chirurgen. Sobald auf den Griff Druck ausgeübt wird, erreicht der Schaft jedoch eine fixe Position.

Die Kunststoffgriffe ergänzen das breite Angebot der bereits bekannten Stahlgriffe. Zur Auswahl steht neben dem Standardmodell auch eines mit deaktivierbarer Sperre. Die neuen Kunststoffgriffe überzeugen durch geringes Gewicht und einfache Handhabung.

Isolierte Schäfte:

Unsere Instrumente sind mit einem isolierten Schaft ausgestattet. Dieser verhindert unerwünschten Stromfluß beim Gebrauch mit anderen Instrumenten, die an Hochfrequenz angeschlossen sind. Isolation entsprechend Norm: DIN EN 60601-2-2.

Auf speziellen Wunsch können diese Instrumente auch mit einem nicht isolierten Schaft geliefert werden.

Längen:

Alle in diesem Katalog aufgeführten starren Laparoskopie-Instrumente weisen die genannten Längen auf. Auf Anfrage können wir jedoch auch jede andere Länge für Sie fertigen.

Hartmetall:

Die Hartmetall-Schneiden sichern eine lange Lebensdauer, einen glatten und weicheren Schnitt, sowie gleichbleibend gute Schnitthaltigkeit.

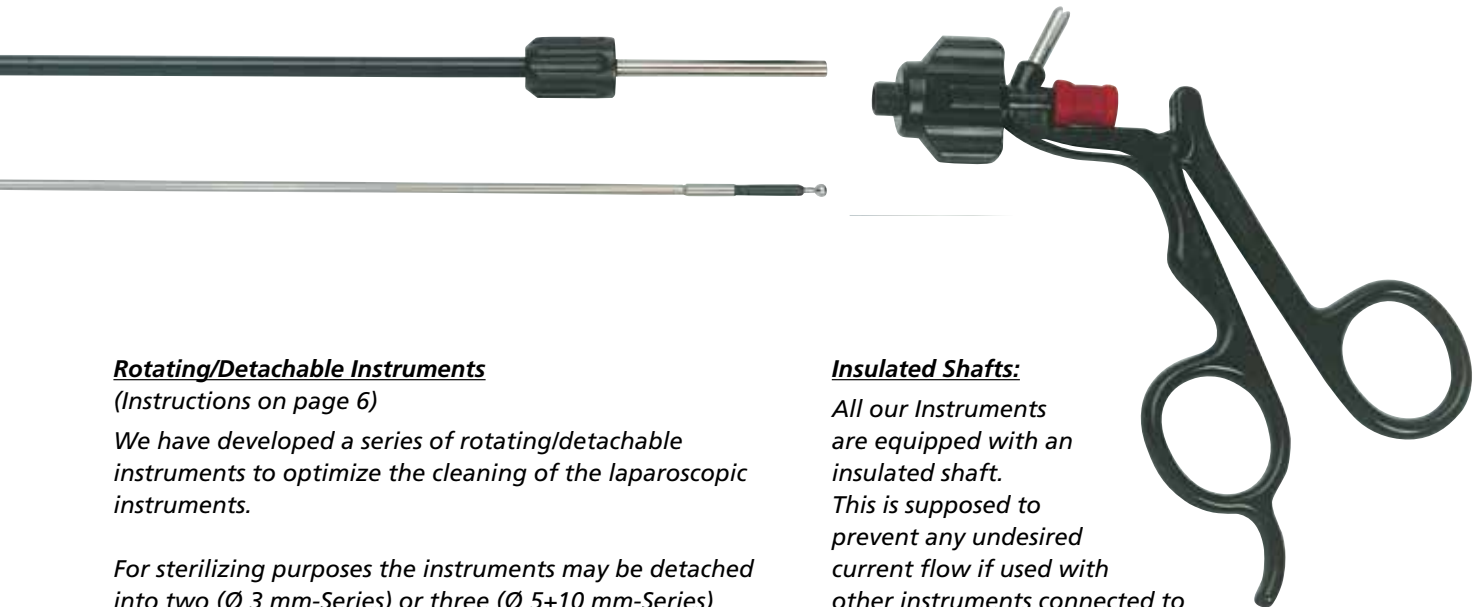

Rotating/Detachable Instruments

(Instructions on page 6)

We have developed a series of rotating/detachable instruments to optimize the cleaning of the laparoscopic instruments.

For sterilizing purposes the instruments may be detached into two (Ø 3 mm-Series) or three (Ø 5+10 mm-Series) components. Due to the design of the compact handle, the handle remains together, i. e. there are no further component parts. The easy reassembling is granted by the compatibility of each part.

Furthermore the instrument's shaft can be rotated by 360°. The ergonomically formed Lamina Screw supports an effortless rotation of the shaft and thus a fatigueless working of the surgeon. As soon as pressure is put onto the handle the shaft gets fixed.

The plastic handles complete the wide range of the already known steel handles. Additionally to the standard model, we offer a handle with deactivating ratchet. Easy handling and light weight are the convincing attitudes of the new plastic handles.

Insulated Shafts:

All our Instruments are equipped with an insulated shaft.

This is supposed to prevent any undesired current flow if used with other instruments connected to High Frequency.

Insulation according norm: DIN EN 60601-2-2.

On special request these instruments can be produced with a non insulated shaft, too.

Lengths:

All rigid instruments for Laparoscopy shown in this catalogue do have the mentioned lengths. On request, we can supply any other length.

Tungsten Carbide:

The Tungsten Carbide Inserts guarantee a very long service-life, a smooth and soft cut, and consistent cutting capacity.



**Zerlegen
des Instruments**
*Detaching
of the Instrument*

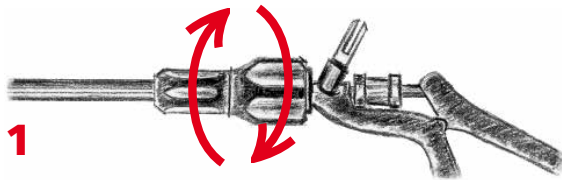

1

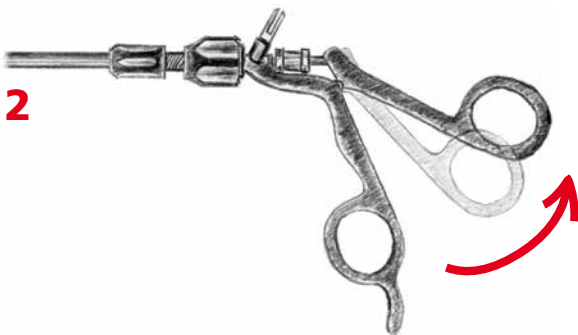

2

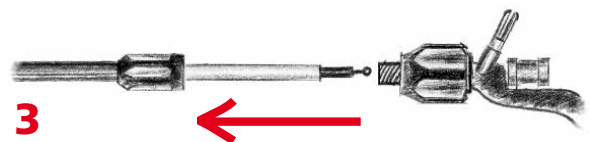

3

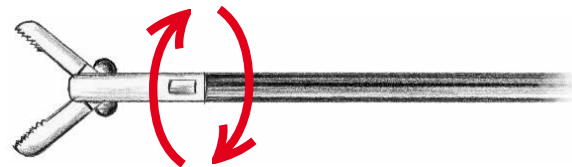

4

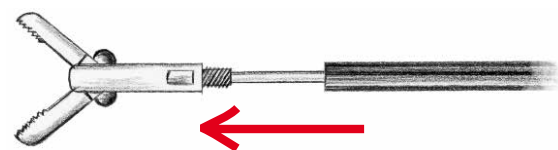

5

1. Lamellen-Schrauben am Schaft gegeneinander drehen.
2. Hinteres Griffteil schiebt sich dabei in die Waagrechte.
3. Schaft/Maulteil-Verbindung aus hinterem Griffteil ausklinken und vom Griff lösen.
4. Maulteil und Schaft gegeneinander drehen.
5. Maulteil vom Schaft lösen.

Montage des Instruments in umgekehrter Reihenfolge!
Bitte darauf achten, daß alle Schraubverbindungen wieder fest angezogen werden!

1. Turn lamina screws on the shaft against each other.
2. Back handle part comes to the horizontal level automatically.
3. Shaft/jaw part unlink connection from back handle part and loosen from handle.
4. Turn jaw part and shaft against each other.
5. Pull out jaw part from shaft.

Reassembling of the instrument in reverse order!
Please pay attention that all screw joints are fixed carefully!

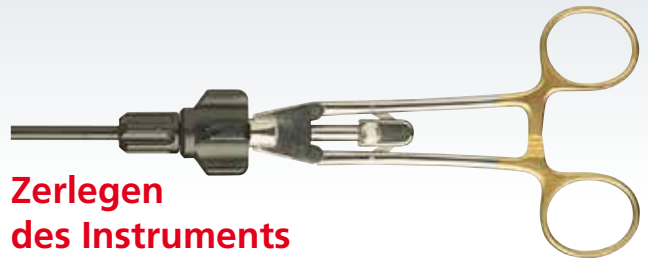

**Zerlegen
des Instruments**

**Detaching
of the Instrument**

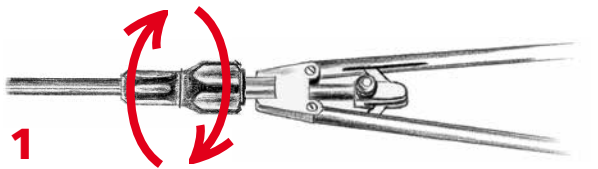

1

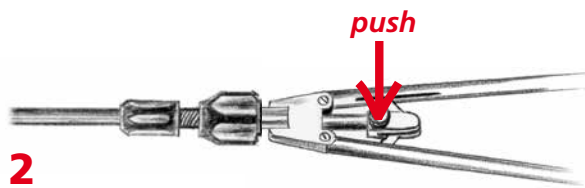

2

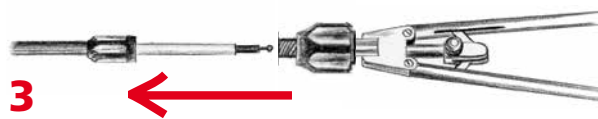

3

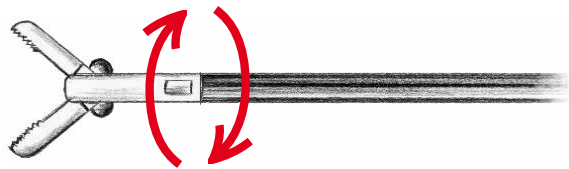

4

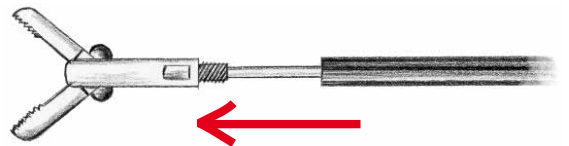

5

1. Griff öffnen und Lamellen-Schrauben am Schaft gegeneinander drehen.
2. Knopf drücken und gleichzeitig
3. den Schaft incl. Zugdraht ausklinken und vom Griff lösen.
4. Maulteil und Schaft gegeneinander drehen.
5. Maulteil vom Schaft lösen.

**Montage des Instruments in umgekehrter Reihenfolge!
Bitte darauf achten, daß alle Schraubverbindungen
wieder fest angezogen werden!**

1. Open the handle and turn lamina screws on the shaft against each other.
2. Push the botton and
3. At the same time unlink the shaft incl. the insert from back handle part and take it off from the handle.
4. Turn jaw part and shaft against each other.
5. Pull out jaw part from shaft.

**Reassembling of the instrument in reverse order!
Please pay attention that all screw joints are fixed
carefully!**

Einzelteile und Aufbau Artikelnummern Components and Structure of Article numbers

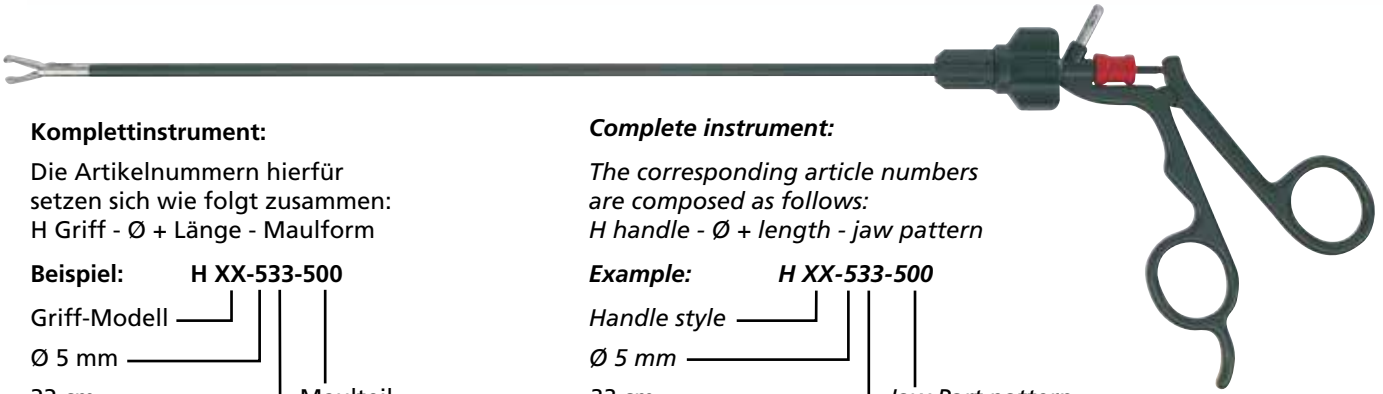

Komplettinstrument:

Die Artikelnummern hierfür setzen sich wie folgt zusammen:
H Griff - Ø + Länge - Maulform

Beispiel: H XX-533-500

Griff-Modell	_____		Maulteil- Form, Hakenschere
Ø 5 mm	_____		
33 cm (ca. Arbeitslänge)	_____		

Bei Bestellung von Maulteil-Einsätzen verwenden sie bitte H00- anstatt die Griff-Modell-Nummer.
z.B.: **H00-533-500**

Complete instrument:

The corresponding article numbers are composed as follows:
H handle - Ø + length - jaw pattern

Example: H XX-533-500

Handle style	_____		Jaw Part pattern, Hook Scissors
Ø 5 mm	_____		
33 cm (apprx. working length)	_____		

To order insert only
Please use H00- instead of handle number.
for example: **H00-533-500**

Schäfte Shafts



Schäfte nicht isoliert Shafts non insulated

A-Länge
W-length Ø mm

330 mm	5	H 30-533-000
330 mm	10	H 30-133-000
450 mm	5	H 30-545-000
450 mm	10	H 30-145-000



Schäfte isoliert Shafts insulated

A-Länge
W-length Ø mm

330 mm	5	H 40-533-000
330 mm	10	H 40-133-000
450 mm	5	H 40-545-000
450 mm	10	H 40-145-000



**Dichtungskappe
Sealing Cap**

H 00-020-000

Griffe
Handles

Axialgriff
Axial handle

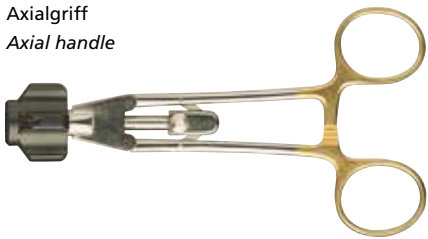

H 19-000-000

Metallgriff
Metal handle



H 30-000-000

Metallgriff
mit Feder
*Metal handle
with spring*

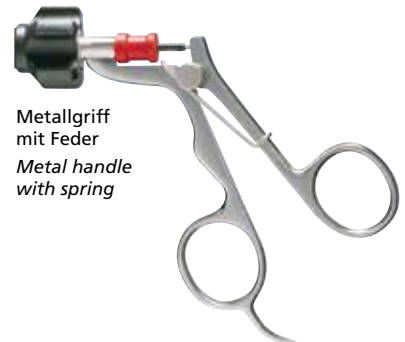

H 31-000-000

Metallgriff
mit Sperre
*Metal handle
with ratchet*



H 35-000-000

Metallgriff
isoliert mit
klappbarer
Sperre
*Metal handle
insulated
with flap
ratchet*



H 38-000-000

Metallgriff
isoliert
*Metal handle
insulated*

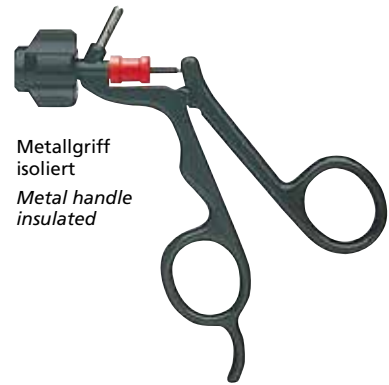

H 40-000-000

Kunststoff-
griff
*Plastic
handle*











H 41-000-000

Kunststoffgriff
mit deaktiver-
barer Sperre
*Plastic
handle with
deactivatable
ratchet*



H 43-000-000

Scheren ohne Hartmetall
Scissors without Tungsten Carbide

		Länge Maulteil Length jaw part	einfach beweglich single action	doppelt beweglich double action	Ø mm	Länge mm Length mm	Einsatz ohne Schaft Insert without shaft
Hakenschere Hook Scissors							
Schere, gerade Scissors, straight		8	×		5	330	H00-533-501
					5	450	H00-545-501
Schere, links gebogen Scissors, left curved		11	×		5	330	H00-533-510
Metzenbaum-Schere, gerade Metzenbaum Scissors, straight		11	×		5	330	H00-533-515
		15		×	5	330	H00-533-530
					5	450	H00-545-530
Metzenbaum-Schere, gebogen, dünnes Blatt Metzenbaum Scissors, curved, thin blade		14		×	5	330	H00-533-533
Metzenbaum-Schere, links gebogen, Metzenbaum Scissors, left curved,		10			3	250	H00-325-535
				×	3	330	H00-333-535
		15			5	330	H00-533-535
					5	450	H00-545-535
Metzenbaum-Schere, gebogen, kurzes dünnes Blatt Metzenbaum Scissors, curved, short thin blade		15		×	5	330	H00-533-539
					5	450	H00-545-539
Mikro-Schere Micro Scissors		6	×		5	330	H00-533-550
Große OP-Schere Large Operating Scissors		22	×		10	330	H00-133-590

Metallgriff
Metal handle



H30-533-501
H30-545-501

H30-533-510

H30-533-515

H30-533-530
H30-545-530

H30-533-533

H30-325-535
H30-333-535
H30-533-535
H30-545-535

H30-533-539
H30-545-539

H30-533-550

H30-133-590

Metallgriff,
isoliert
Metal handle,
insulated



H40-533-501
H40-545-501

H40-533-510

H40-533-515

H40-533-530
H40-545-530

H40-533-533

H40-325-535
H40-333-535
H40-533-535
H40-545-535

H40-533-539
H40-545-539

H40-533-550

H40-133-590

Kunststoffgriff
Plastic handle



H41-533-501
H41-545-501

H41-533-510

H41-533-515

H41-533-530
H41-545-530

H41-533-533

H41-325-535
H41-333-535
H41-533-535
H41-545-535

H41-533-539
H41-545-539

H41-533-550

H41-133-590

Scheren mit Hartmetall
Scissors with Tungsten Carbide

Schere mit Hartmetall, gerade
Scissors with Tungsten Carbide, straight



Schere mit Hartmetall, links gebogen
Scissors with Tungsten Carbide, left curved



Metzenbaum-Schere mit Hartmetall, gerade,
Metzenbaum Scissors with Tungsten Carbide,



Metzenbaum-Schere mit Hartmetall, links gebogen
Metzenbaum Scissors with Tungsten Carbide, left curved



Große OP-Schere mit Hartmetall
Large Operating Scissors with Tungsten Carbide



Länge Maulteil* Length jaw part*	einfach beweglich single action	doppelt beweglich double action	Ø mm	Länge mm Length mm	Einsatz ohne Schaft Insert without shaft
11	×		5	330	H00-533-510HM
11	×		5	330	H00-533-515HM
15		×	5	330	H00-533-530HM
15		×	5 5	330 450	H00-533-535HM H00-545-535HM
22	×		10	330	H00-133-590HM

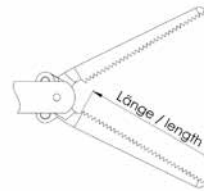

*Richtwert - kein Prüfmaß

*Approx. value - no inspection dimension

Metallgriff
Metal handle



Metallgriff,
isoliert
Metal handle,
insulated



Kunststoffgriff
Plastic handle



H30-533-510HM

H40-533-510HM

H41-533-510HM

H30-533-515HM

H40-533-515HM

H41-533-515HM

H30-533-530HM

H40-533-530HM

H41-533-530HM

H30-533-535HM
H30-545-535HM

H40-533-535HM
H40-545-535HM





H41-533-535HM
H41-545-535HM

H30-133-590HM

H40-133-590HM

H41-133-590HM

Faßzangen
Grasping Forceps

		Länge Maulteil* Length jaw part*	einfach beweglich single action	doppelt beweglich double action	Ø mm	Länge mm Length mm	Einsatz ohne Schaft Insert without shaft	
Faßzange gezahnt <i>Grasping Forceps serrated</i>		7			3	250	H00-325-680	
				×	3	330	H00-333-680	
		12			×	5	330	H00-533-680
						5	450	H00-545-680
Spitze Faßzange <i>Tapered Grasping Forceps</i>		12		×	5	330	H00-533-700	
Delphin Faßzange <i>Dolphine-Nose Forceps</i>		7			3	250	H00-325-610	
				×	3	330	H00-333-610	
		12			×	5	330	H00-533-610
						5	450	H00-545-610
Fundus Faßzange <i>Fundus Forceps</i>		12		×	5	330	H00-533-630	
					5	450	H00-545-630	
Fundus Faßzange, lang <i>Fundus Forceps, long</i>		18		×	5	330	H00-533-631	
					5	450	H00-545-631	

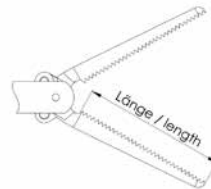

*Richtwert - kein Prüfmaß
*Approx. value - no inspection dimension

Metallgriff
Metal handle



H35-325-680
H35-333-680
H35-533-680
H35-545-680

Metallgriff,
isoliert
Metal handle,
insulated



H38-325-680
H38-333-680
H38-533-680
H38-545-680

Metallgriff,
isoliert
Metal handle,
insulated



H40-325-680
H40-333-680
H40-533-680
H40-545-680

Kunststoffgriff
Plastic handle



H41-325-680
H41-333-680
H41-533-680
H41-545-680

Kunststoffgriff
Plastic handle



H43-325-680
H43-333-680
H43-533-680
H43-545-680

H35-533-700

H38-533-700

H40-533-700

H41-533-700

H43-533-700

H35-325-610
H35-333-610
H35-533-610
H35-545-610

H38-325-610
H38-333-610
H38-533-610
H38-545-610

H40-325-610
H40-333-610
H40-533-610
H40-545-610

H41-325-610
H41-333-610
H41-533-610
H41-545-610

H43-325-610
H43-333-610
H43-533-610
H43-545-610

H35-533-630
H35-545-630

H38-533-630
H38-545-630

H40-533-630
H40-545-630

H41-533-630
H41-545-630

H43-533-630
H43-545-630

H35-533-631
H35-545-631









H38-533-631
H38-545-631

H40-533-631
H40-545-631

H41-533-631
H41-545-631

H43-533-631
H43-545-631

Faßzangen
Grasping Forceps

		Länge Maulteil Length jaw part	einfach beweglich single action	doppelt beweglich double action	Ø mm	Länge mm Length mm	Einsatz ohne Schaft Insert without shaft
Faßzange konisch <i>Grasping Forceps conical</i>							
Atraumatische Faßzange <i>Atraumatic Grasping Forceps</i>		13		×	5	330	H00-533-780
		13		×	5	330	H00-533-581
Faßzange fein gezahnt <i>Grasping Forceps fine serrated</i>							
		12		×	3	250	H00-325-720
					3	330	H00-333-720
					5	330	H00-533-720
					5	450	H00-545-720
Faßzange fein gezahnt, lang <i>Grasping Forceps fine serrated, long</i>		17		×	5	330	H00-533-721
					5	450	H00-545-721
Faßzange grob gezahnt <i>Grasping Forceps serrated</i>		12		×	5	330	H00-533-731
					5	450	H00-545-731
Faßzange grob gezahnt, lang <i>Grasping Forceps serrated, long</i>		17		×	5	330	H00-533-732
					5	450	H00-545-732
Alligator-Faßzange <i>Alligator Forceps</i>				×			
		7			3	250	H00-325-820
					3	330	H00-333-820
		12			5	330	H00-533-821
					5	450	H00-545-821
Alligator-Faßzange, lang <i>Alligator Forceps, long</i>		17		×	5	330	H00-533-822
					5	450	H00-545-822

Metallgriff
Metal handle



Metallgriff,
isoliert
Metal handle,
insulated



Metallgriff,
isoliert
Metal handle,
insulated



Kunststoffgriff
Plastic handle



Kunststoffgriff
Plastic handle



H35-533-780

H38-533-780

H40-533-780

H41-533-780

H43-533-780

H35-533-581

H38-533-581

H40-533-581

H41-533-581

H43-533-581

H35-325-720
H35-333-720
H35-533-720
H35-545-720

H38-325-720
H38-333-720
H38-533-720
H38-545-720

H40-325-720
H40-333-720
H40-533-720
H40-545-720

H41-325-720
H41-333-720
H41-533-720
H41-545-720

H43-325-720
H43-333-720
H43-533-720
H43-545-720

H35-533-721
H35-545-721

H38-533-721
H38-545-721

H40-533-721
H40-545-721

H41-533-721
H41-545-721

H43-533-721
H43-545-721

H35-533-731
H35-545-731

H38-533-731
H38-545-731

H40-533-731
H40-545-731

H41-533-731
H41-545-731

H43-533-731
H43-545-731

H35-533-732
H35-545-732

H38-533-732
H38-545-732

H40-533-732
H40-545-732

H41-533-732
H41-545-732

H43-533-732
H43-545-732

H35-325-820
H35-333-820
H35-533-821
H35-545-821

H38-325-820
H38-333-820
H38-533-821
H38-545-821

H40-325-820
H40-333-820
H40-533-821
H40-545-821

H41-325-820
H41-333-820
H41-533-821
H41-545-821

H43-325-820
H43-333-820
H43-533-821
H43-545-821

H35-533-822
H35-545-822

H38-533-822
H38-545-822

H40-533-822
H40-545-822

H41-533-822
H41-545-822

H43-533-822
H43-545-822

Faßzangen
Grasping Forceps

Scharfe Faßzange,
1x2 Zähne
*Traumatic Grasping
Forceps, 1x2 teeth*



Scharfe Faßzange,
1x2 Zähne
*Traumatic Grasping
Forceps, 1x2 teeth*



Atraumatische Faßzange
*Atraumatic Grasping
Forceps*



Atraumatische Faßzange
*Atraumatic Grasping
Forceps*



Atraumatische Faßzange
*Atraumatic Grasping
Forceps*



Kelly-Faßzange
Kelly Forceps



Länge Maulteil* Length jaw part*	einfach beweglich single action	doppelt beweglich double action	Ø mm	Länge mm Length mm	Einsatz ohne Schaft Insert without shaft
12	×		5	330	H00-533-740
			5	450	H00-545-740
7			3	250	H00-325-741
		×	3	330	H00-333-741
12			5	330	H00-533-741
			5	450	H00-545-741
13	×		5	330	H00-533-830
19	×		5	330	H00-533-760
			5	450	H00-545-760
19		×	5	330	H00-533-761
9			3	250	H00-325-990
		×	3	330	H00-333-990
14			5	330	H00-533-990
			5	450	H00-545-990

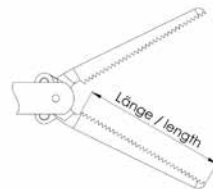

*Richtwert - kein Prüfmaß

*Approx. value - no inspection dimension

Metallgriff
Metal handle



H35-533-740
H35-545-740

H35-325-741
H35-333-741
H35-533-741
H35-545-741

H35-533-830

H35-533-760
H35-545-760

H35-533-761

H35-325-990
H35-333-990
H35-533-990
H35-545-990

Metallgriff,
isoliert
Metal handle,
insulated



H38-533-740
H38-545-740

H38-325-741
H38-333-741
H38-533-741
H38-545-741

H38-533-830

H38-533-760
H38-545-760

H38-533-761

H38-325-990
H38-333-990
H38-533-990
H38-545-990

Metallgriff,
isoliert
Metal handle,
insulated



H40-533-740
H40-545-740

H40-325-741
H40-333-741
H40-533-741
H40-545-741

H40-533-830

H40-533-760
H40-545-760

H40-533-761

H40-325-990
H40-333-990
H40-533-990
H40-545-990

Kunststoffgriff
Plastic handle



H41-533-740
H41-545-740

H41-325-741
H41-333-741
H41-533-741
H41-545-741

H41-533-830

H41-533-760
H41-545-760

H41-533-761

H41-325-990
H41-333-990
H41-533-990
H41-545-990

Kunststoffgriff
Plastic handle



H43-533-740
H43-545-740

H43-325-741
H43-333-741
H43-533-741
H43-545-741

H43-533-830

H43-533-760
H43-545-760

H43-533-761

H43-325-990
H43-333-990
H43-533-990
H43-545-990

Faßzangen
Grasping Forceps

Faßzange, grob gezahnt,
Fenster

*Fenestrated Forceps,
serrated*

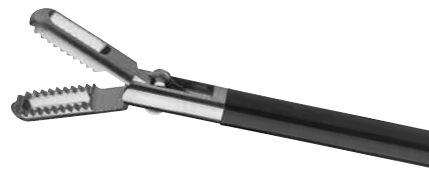

Faßzange, fein gezahnt,
Fenster

*Fenestrated Forceps, fine
serrated*



Faßzange, fein gezahnt,
Fenster

*Fenestrated Forceps, fine
serrated*



Faßzange, fein gezahnt,
Fenster

*Fenestrated Forceps,
fine serrated*



Faßzange, fein gezahnt,
Fenster

*Fenestrated Forceps,
fine serrated*



Faßzange, fein gezahnt,
Fenster

*Fenestrated Forceps,
fine serrated*

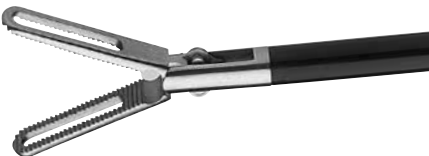

Faßzange, grob gezahnt,
Fenster

*Fenestrated Forceps,
serrated*



Faßzange, fein gezahnt,
Fenster

*Fenestrated Forceps,
fine serrated*



Länge Maulteil* Length jaw part*	einfach beweglich single action	doppelt beweglich double action	Ø mm	Länge mm Length mm	Einsatz ohne Schaft Insert without shaft
15		x	5	330	H00-533-670
			5	450	H00-545-670
16			10	330	H00-133-690
			10	450	H00-145-690
9		x	3	330	H00-333-710
			5	330	H00-533-710
			5	450	H00-545-710
12	x		3	250	H00-325-714
			3	330	H00-333-714
			5	330	H00-533-714
			5	450	H00-545-714
12		x	3	250	H00-325-716
			3	330	H00-333-716
			5	330	H00-533-716
			5	450	H00-545-716
13	x		3	330	H00-333-717
			5	330	H00-533-717
			5	450	H00-545-717
13		x	3	250	H00-325-718
			3	330	H00-333-718
			5	330	H00-533-718
			5	450	H00-545-718
20		x	5	330	H00-533-672
			5	450	H00-545-672
17		x	5	330	H00-533-708
			5	450	H00-545-708

Metallgriff
Metal handle



H35-533-670
H35-545-670
H35-133-690
H35-145-690

H35-333-710
H35-533-710
H35-545-710

H35-325-714
H35-333-714
H35-533-714
H35-545-714

H35-325-716
H35-333-716
H35-533-716
H35-545-716

H35-333-717
H35-533-717
H35-545-717

H35-325-718
H35-333-718
H35-533-718
H35-545-718

H35-533-672
H35-545-672

H35-533-708
H35-545-708

Metallgriff,
isoliert
Metal handle,
insulated



H38-533-670
H38-545-670
H38-133-690
H38-145-690

H38-333-710
H38-533-710
H38-545-710

H38-325-714
H38-333-714
H38-533-714
H38-545-714

H38-325-716
H38-333-716
H38-533-716
H38-545-716

H38-333-717
H38-533-717
H38-545-717

H38-325-718
H38-333-718
H38-533-718
H38-545-718

H38-533-672
H38-545-672

H38-533-708
H38-545-708

Metallgriff,
isoliert
Metal handle,
insulated



H40-533-670
H40-545-670
H40-133-690
H40-145-690

H40-333-710
H40-533-710
H40-545-710

H40-325-714
H40-333-714
H40-533-714
H40-545-714

H40-325-716
H40-333-716
H40-533-716
H40-545-716

H40-333-717
H40-533-717
H40-545-717

H40-325-718
H40-333-718
H40-533-718
H40-545-718

H40-533-672
H40-545-672

H40-533-708
H40-545-708

Kunststoffgriff
Plastic handle



H41-533-670
H41-545-670
H41-133-690
H41-145-690

H41-333-710
H41-533-710
H41-545-710

H41-325-714
H41-333-714
H41-533-714
H41-545-714

H41-325-716
H41-333-716
H41-533-716
H41-545-716

H41-333-717
H41-533-717
H41-545-717

H41-325-718
H41-333-718
H41-533-718
H41-545-718

H41-533-672
H41-545-672

H41-533-708
H41-545-708

Kunststoffgriff
Plastic handle



H43-533-670
H43-545-670
H43-133-690
H43-145-690

H43-333-710
H43-533-710
H43-545-710

H43-325-714
H43-333-714
H43-533-714
H43-545-714

H43-325-716
H43-333-716
H43-533-716
H43-545-716

H43-333-717
H43-533-717
H43-545-717

H43-325-718
H43-333-718
H43-533-718
H43-545-718

H43-533-672
H43-545-672

H43-533-708
H43-545-708

Faßzangen Grasping Forceps

Faßzange, extra schmal und kurz, Fenster
Fenestrated Forceps, extra narrow and short



Faßzange, gewölbt, gezahnt, Fenster
Fenestrated Forceps, arched, serrated



Lange Faßzange, fein gezahnt, mit Fenster, dünne Stege
Long fenestrated Forceps, fine bars



Faßzange, gezahnt, Löffel
Grasping Forceps, serrated, spoon



Faßzange, gezahnt, Löffel
Grasping Forceps, serrated, spoon



Faßzange, gezahnt, 2 x 3 Zähne
Grasping Forceps, serrated, 2 x 3 teeth



Länge Maulteil* Length jaw part*	einfach beweglich single action	doppelt beweglich double action	Ø mm	Länge mm Length mm	Einsatz ohne Schaft Insert without shaft
10		×	5	330	H00-533-712
11		×	5	330	H00-533-713
18	×		5	330	H00-533-719
20	×		5 5	330 450	H00-533-682 H00-545-682
12			3	250	H00-325-683
19		×	3 5 5	330 330 450	H00-333-683 H00-533-683 H00-545-683
17	×		5 5	330 450	H00-533-742 H00-545-742

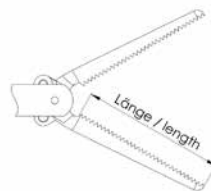

*Richtwert - kein Prüfmaß

*Approx. value - no inspection dimension

Metallgriff
Metal handle



Metallgriff,
isoliert
Metal handle,
insulated



Metallgriff,
isoliert
Metal handle,
insulated



Kunststoffgriff
Plastic handle



Kunststoffgriff
Plastic handle



H35-533-712

H38-533-712

H40-533-712

H41-533-712

H43-533-712

H35-533-713

H38-533-713

H40-533-713

H41-533-713

H43-533-713

H35-533-719

H38-533-719

H40-533-719

H41-533-719

H43-533-719

H35-533-682
H35-545-682

H38-533-682
H38-545-682

H40-533-682
H40-545-682

H41-533-682
H41-545-682

H43-533-682
H43-545-682

H35-325-683
H35-333-683
H35-533-683
H35-545-683

H38-325-683
H38-333-683
H38-533-683
H38-545-683

H40-325-683
H40-333-683
H40-533-683
H40-545-683

H41-325-683
H41-333-683
H41-533-683
H41-545-683

H43-325-683
H43-333-683
H43-533-683
H43-545-683

H35-533-742
H35-545-742

H38-533-742
H38-545-742

H40-533-742
H40-545-742

H41-533-742
H41-545-742

H43-533-742
H43-545-742

Faßzangen
Grasping Forceps

	Länge Maulteil Length jaw part	einfach beweglich single action	doppelt beweglich double action	Ø mm	Länge mm Length mm	Einsatz ohne Schaft Insert without shaft
Maryland-Faßzange, lang <i>Maryland Forceps, long</i>	21	×		5	330	H00-533-771
Maryland-Faßzange, kurz <i>Maryland Forceps, short</i>	9			3	250	H00-325-772
				3	330	H00-333-772
	15		×	5	330	H00-533-772
				5	450	H00-545-772
Maryland-Faßzange <i>Maryland Forceps</i>	12			3	250	H00-325-770
				3	330	H00-333-770
	21		×	5	330	H00-533-770
				5	450	H00-545-770
Lange Faßzange, fein gezahnt, mit Fenster, dünne Stege <i>Long fenestred Forceps, fine bars</i>	19			10	330	H00-133-770
				10	450	H00-145-770
Mixer-Faßzange 90° <i>Mixer Forceps 90°</i>	24		×	5	330	H00-533-801
				5	450	H00-545-801
Mixer-Faßzange 45° <i>Mixer Forceps 45°</i>	17		×	10	330	H00-133-800
				10	450	H00-145-800
	24		×	5	330	H00-533-803
				5	450	H00-545-803
Faßzange lang, fein gezahnt, Fenster <i>Fenestred Forceps, long, fine serrated</i>	23		×	10	330	H00-133-804
				10	450	H00-145-804
O'Shaugnessy Faßzange <i>O'Shaugnessy Forceps</i>	43	×		5	330	H00-533-722
				5	450	H00-545-722
	49		×	10	330	H00-133-773
				10	450	H00-145-773

Metallgriff
Metal handle



Metallgriff,
isoliert
Metal handle,
insulated



Metallgriff,
isoliert
Metal handle,
insulated



Kunststoffgriff
Plastic handle



Kunststoffgriff
Plastic handle



H35-533-771

H38-533-771

H40-533-771

H41-533-771

H43-533-771

H35-325-772
H35-333-772
H35-533-772
H35-545-772

H38-325-772
H38-333-772
H38-533-772
H38-545-772

H40-325-772
H40-333-772
H40-533-772
H40-545-772

H41-325-772
H41-333-772
H41-533-772
H41-545-772

H43-325-772
H43-333-772
H43-533-772
H43-545-772

H35-325-770
H35-333-770
H35-533-770
H35-545-770
H35-133-770
H35-145-770

H38-325-770
H38-333-770
H38-533-770
H38-545-770
H38-133-770
H38-145-770

H40-325-770
H40-333-770
H40-533-770
H40-545-770
H40-133-770
H40-145-770

H41-325-770
H41-333-770
H41-533-770
H41-545-770
H41-133-770
H41-145-770

H43-325-770
H43-333-770
H43-533-770
H43-545-770
H43-133-770
H43-145-770

H35-533-725
H35-545-725

H38-533-725
H38-545-725

H40-533-725
H40-545-725

H41-533-725
H41-545-725

H43-533-725
H43-545-725

H35-533-801
H35-545-801
H35-133-800
H35-145-800

H38-533-801
H38-545-801
H38-133-800
H38-145-800

H40-533-801
H40-545-801
H40-133-800
H40-145-800

H41-533-801
H41-545-801
H41-133-800
H41-145-800

H43-533-801
H43-545-801
H43-133-800
H43-145-800

H35-533-803
H35-545-803
H35-133-804
H35-145-804

H38-533-803
H38-545-803
H38-133-804
H38-145-804

H40-533-803
H40-545-803
H40-133-804
H40-145-804

H41-533-803
H41-545-803
H41-133-804
H41-145-804

H43-533-803
H43-545-803
H43-133-804
H43-145-804

H35-533-722
H35-545-722

H38-533-722
H38-545-722

H40-533-722
H40-545-722

H41-533-722
H41-545-722

H43-533-722
H43-545-722

H35-133-773
H35-145-773









H38-133-773
H38-145-773

H40-133-773
H40-145-773

H41-133-773
H41-145-773

H43-133-773
H43-145-773

Biopsiezangen
Biopsy Forceps

		Länge Maulteil* Length jaw part*	einfach beweglich single action	doppelt beweglich double action	Ø mm	Länge mm Length mm	Einsatz ohne Schaft Insert without shaft
Biopsie-Zange <i>Biopsy Forceps</i>		5			3	250	H00-325-641
				×	3	330	H00-333-641
		10			5	330	H00-533-641
					5	450	H00-545-641
Biopsie-Zange mit Dorn <i>Biopsy Forceps with thorn</i>		10		×	5	330	H00-533-661
					5	450	H00-545-661
Große Löffelzange <i>Large Spoon Forceps</i>		24	×		10	330	H00-133-970
					10	450	H00-145-970
Biopsie-Zange, langes Maul <i>Biopsy Forceps, long jaw</i>		16	×		5	330	H00-533-645
Biopsie-Zange mit Zähnen <i>Biopsy Forceps with teeth</i>		10		×	5	330	H00-533-751

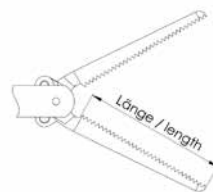

*Richtwert - kein Prüfmaß

*Approx. value - no inspection dimension

Metallgriff
Metal handle



H30-325-641
H30-333-641
H30-533-641
H30-545-641

Metallgriff
Metal handle



H31-325-641
H31-333-641
H31-533-641
H31-545-641

Metallgriff,
isoliert
Metal handle,
insulated



H40-325-641
H40-333-641
H40-533-641
H40-545-641

Kunststoffgriff
Plastic handle



H41-325-641
H41-333-641
H41-533-641
H41-545-641

Kunststoffgriff
Plastic handle



H43-325-641
H43-333-641
H43-533-641
H43-545-641

H30-533-661
H30-545-661

H31-533-661
H31-545-661

H40-533-661
H40-545-661

H41-533-661
H41-545-661

H43-533-661
H43-545-661

H30-133-970
H30-145-970

H31-133-970
H31-145-970

H40-133-970
H40-145-970

H41-133-970
H41-145-970

H43-133-970
H43-145-970

H30-533-645

H31-533-645

H40-533-645

H41-533-645

H43-533-645

H30-533-751









H31-533-751

H40-533-751

H41-533-751

H43-533-751

Klemmen
Clamps

		Länge Maulteil Length jaw part	einfach beweglich single action	doppelt beweglich double action	Ø mm	Länge mm Length mm	Einsatz ohne Schaft Insert without shaft
Babcock-Klemme <i>Babcock Clamp</i>		31			5	330	H00-533-901
				×	5	450	H00-545-901
		51			10	330	H00-133-900
					10	450	H00-145-900
Duval-Klemme <i>Duval Clamp</i>		50		×	10	330	H00-133-910
							
Allis-Klemme <i>Allis Clamp</i>		31			5	330	H00-533-920
				×	5	450	H00-545-920
		51			10	330	H00-133-921
DeBakey-Klemme <i>DeBakey Clamp</i>		35			5	330	H00-533-940
		50		×	10	330	H00-133-941
Pennington-Klemme <i>Pennington Clamp</i>		31			5	330	H00-533-960
		50		×	10	330	H00-133-961
Tenaculum Faßzange <i>Tenaculum Forceps</i>		27			5	330	H00-533-954
				×	5	450	H00-545-954
					10	330	H00-133-955
					10	450	H00-145-955

Metallgriff
Metal handle



H31-533-901
H31-545-901
H31-133-900
H31-145-900

Metallgriff
Metal handle



H35-533-901
H35-545-901
H35-133-900
H35-145-900

Metallgriff,
isoliert
Metal handle,
insulated



H38-533-901
H38-545-901
H38-133-900
H38-145-900

Kunststoffgriff
Plastic handle



H43-533-901
H43-545-901
H43-133-900
H43-145-900

H31-133-910

H35-133-910

H38-133-910

H43-133-910

H31-533-920
H31-545-920
H31-133-921

H35-533-920
H35-545-920
H35-133-921

H38-533-920
H38-545-920
H38-133-921

H43-533-920
H43-545-920
H43-133-921

H31-533-940
H31-133-941

H35-533-940
H35-133-941

H38-533-940
H38-133-941

H43-533-940
H43-133-941

H31-533-960
H31-133-961

H35-533-960
H35-133-961

H38-533-960
H38-133-961

H43-533-960
H43-133-961

H31-533-954
H31-545-954
H31-133-955
H31-145-955

H35-533-954
H35-545-954
H35-133-955
H35-145-955

H38-533-954
H38-545-954
H38-133-955
H38-145-955

H43-533-954
H43-545-954
H43-133-955
H43-145-955

Klemmen
Clamps

Krallengreifer
Claw Grasping Forceps



Länge Maulteil <i>Length jaw part</i>	einfach beweglich <i>single action</i>	doppelt beweglich <i>double action</i>	Ø mm	Länge mm <i>Length mm</i>	Einsatz ohne Schaft <i>Insert without shaft</i>	
17	×		5	330	H00-533-950	
			5	450	H00-545-950	
33				10	330	H00-133-951
				10	450	H00-145-951
50		×	10	330	H00-133-765	
35			5	330	H00-533-810	

Atrauma-Klemme
Atraumatic Clamp



Dorsey-Klemme
Dorsey Clamp



Stanzen
Punches

Biopsie-Stanze
Biopsy Punch



Länge Maulteil <i>Length jaw part</i>	einfach beweglich <i>single action</i>	doppelt beweglich <i>double action</i>	Ø mm	Länge mm <i>Length mm</i>	Einsatz ohne Schaft <i>Insert without shaft</i>
10	×		5	330	H00-533-521

Metallgriff
Metal handle



H31-533-950
H31-545-950
H31-133-951
H31-145-951

Metallgriff
Metal handle



H35-533-950
H35-545-950
H35-133-951
H35-145-951

Metallgriff,
isoliert
Metal handle,
insulated



H38-533-950
H38-545-950
H38-133-951
H38-145-951

Kunststoffgriff
Plastic handle



H43-533-950
H43-545-950
H43-133-951
H43-145-951

H31-133-765

H35-133-765

H38-133-765

H43-133-765

H31-533-810

H35-533-810

H38-533-810

H43-533-810

Metallgriff
Metal handle



H30-533-521

Metallgriff,
isoliert
Metal handle,
insulated













H40-533-521

Kunststoffgriff
Plastic handle



H41-533-521

**Nadelhalter mit/ohne
Hartmetall**
**Needle Holders with/
without Tungsten Carbide**

		Länge Maulteil Length jaw part	einfach beweglich single action	doppelt beweglich double action	Ø mm	Länge mm Length mm	Einsatz ohne Schaft Insert without shaft
DeBaKey mit Hartmetall <i>DeBaKey with Tungsten Carbide</i>		13	×		5	330	H00-533-110HM
		13		×	5	450	H00-545-110HM
DeBaKey mit Hartmetall <i>DeBaKey with Tungsten Carbide</i>		13	×		5	330	H00-533-120HM
		13		×	5	330	H00-533-120HM
Mayo-Hegar mit Hartmetall <i>Mayo-Hegar with Tungsten Carbide</i>		13	×		5	330	H00-533-111HM
		13		×	5	450	H00-545-111HM
Mayo-Hegar mit Hartmetall <i>Mayo-Hegar with Tungsten Carbide</i>		13		×	5	330	H00-533-121HM
		13		×	5	330	H00-533-121HM
French-Eye mit Hartmetall <i>French-Eye with Tungsten Carbide</i>		8			3	250	H00-325-113HM
		13	×		3	330	H00-333-113HM
		10			5	330 curved	H00-533-114HM
		10			5	450 curved	H00-545-114HM
French-Eye mit Hartmetall <i>French-Eye with Tungsten Carbide</i>		10		×	5	330	H00-533-123HM
		10		×	5	450	H00-545-124HM
Nadelhalter ohne Hartmetall <i>Needleholder without Tungsten Carbide</i>		13	×		5	330	H00-533-635
Nadelhalter ohne Hartmetall, 60° abgewinkelt <i>Needleholder without Tungsten Carbide, 60° angled</i>		14		×	10	330	H00-133-985

H18... Instrumente sind nicht zerlegbar
H18... Instruments are not detachable

Axialgriff Metall
Axial handle metal



Axialgriff Metall
Axial handle metal



Metallgriff,
Metal handle,



Metallgriff,
isoliert
Metal handle,
insulated



Kunststoffgriff
Plastic handle



H18-533-110HM
H18-545-110HM

H19-533-110HM
H19-545-110HM

H35-533-110HM
H35-545-110HM

H38-533-110HM
H38-545-110HM

H43-533-110HM
H43-545-110HM

H18-533-120HM

H19-533-120HM

H35-533-120HM

H38-533-120HM

H43-533-120HM

H18-533-111HM
H18-545-111HM

H19-533-111HM
H19-545-111HM

H35-533-111HM
H35-545-111HM

H38-533-111HM
H38-545-111HM

H43-533-111HM
H43-545-111HM

H18-533-121HM

H19-533-121HM

H35-533-121HM

H38-533-121HM

H43-533-121HM

H18-533-113HM
H18-533-114HM
H18-545-114HM

H19-533-113HM
H19-533-114HM
H19-545-114HM

H35-325-113HM
H35-333-113HM
H35-533-113HM
H35-533-114HM
H35-545-114HM

H38-325-113HM
H38-333-113HM
H38-533-113HM
H38-533-114HM
H38-545-114HM

H43-325-113HM
H43-333-113HM
H43-533-113HM
H43-533-114HM
H43-545-114HM

H18-533-123HM
H18-545-124HM

H19-533-123HM
H19-545-124HM

H35-533-123HM
H35-545-124HM

H38-533-123HM
H38-545-124HM

H43-533-123HM
H43-545-124HM

H18-533-635

H19-533-635

H35-533-635

H38-533-635

H43-533-635

H18-133-985

H19-133-985

H35-133-985

H38-133-985

H43-133-985

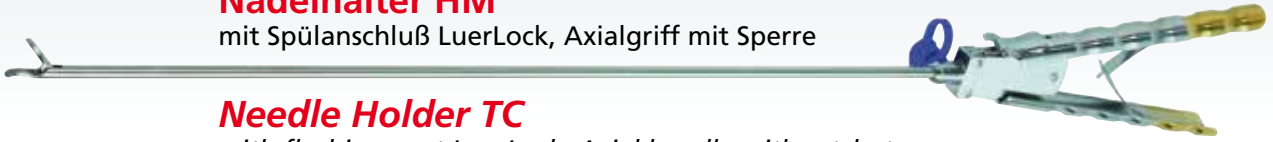

Nadelhalter HM

mit Spülanschluß LuerLock, Axialgriff mit Sperre



Needle Holder TC

with flushing port LuerLock, Axial handle with ratchet

Maulteil Jaw part	Ø mm	NL mm WL mm		
gerade straight	5	330	H16-533-350HM	H16-533-353HM
	5	450	H16-545-350HM	H16-545-353HM
links gebogen left curved	5	330	H16-533-351HM	H16-533-354HM
	5	450	H16-545-351HM	H16-545-354HM
rechts gebogen right curved	5	330	H16-533-352HM	H16-533-355HM
	5	450	H16-545-352HM	H16-545-355HM
konvex-konkav/mit Fixierzähnen convex-concave/with fixation teeth	5	330	H16-533-356HM	H16-533-357HM
	5	450	H16-545-356HM	H16-545-357HM

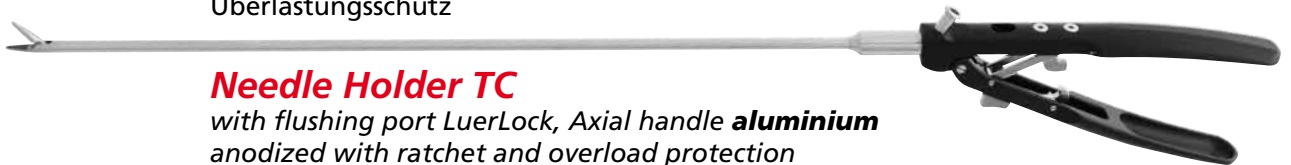

Nadelhalter HM

mit Spülanschluß LuerLock, Axialgriff **Aluminium** anodisiert mit Sperre und Überlastungsschutz



Needle Holder TC

with flushing port LuerLock, Axial handle **aluminium** anodized with ratchet and overload protection

Maulteil Jaw part	Ø mm	NL mm WL mm		
gerade straight	5	330	H17-533-033HM	H17-533-034HM
	5	450	H17-545-033HM	H17-545-034HM
links gebogen left curved	5	330	H17-533-133HM	H17-533-134HM
	5	450	H17-545-133HM	H17-545-134HM
rechts gebogen right curved	5	330	H17-533-233HM	H17-533-234HM
	5	450	H17-545-233HM	H17-545-234HM
aufwärts gebogen upwards curved	5	330	H17-533-333HM	H17-533-334HM
	5	450	H17-545-333HM	H17-545-334HM

Clipanlegezange

drehbar und zerlegbar

Clip Applying Forceps

rotatable and detachable

Ø mm	Länge mm <i>longeur mm</i>	für Clip-Größe <i>for Clip Size</i>	für Pilling Weck Clips <i>for Pilling Weck Clips</i>	für Ethicon Clips <i>for Ethicon Clips</i>
5	330	klein <i>small</i>	H30-533-881 P	H30-533-881 E
10	330	mittel <i>medium</i>	H30-133-882 P	H30-133-882 E
10	330	mittel / groß <i>medium large</i>	H30-133-883 P	H30-133-883 E
10	330	groß <i>large</i>	H30-133-884 P	H30-133-884 E

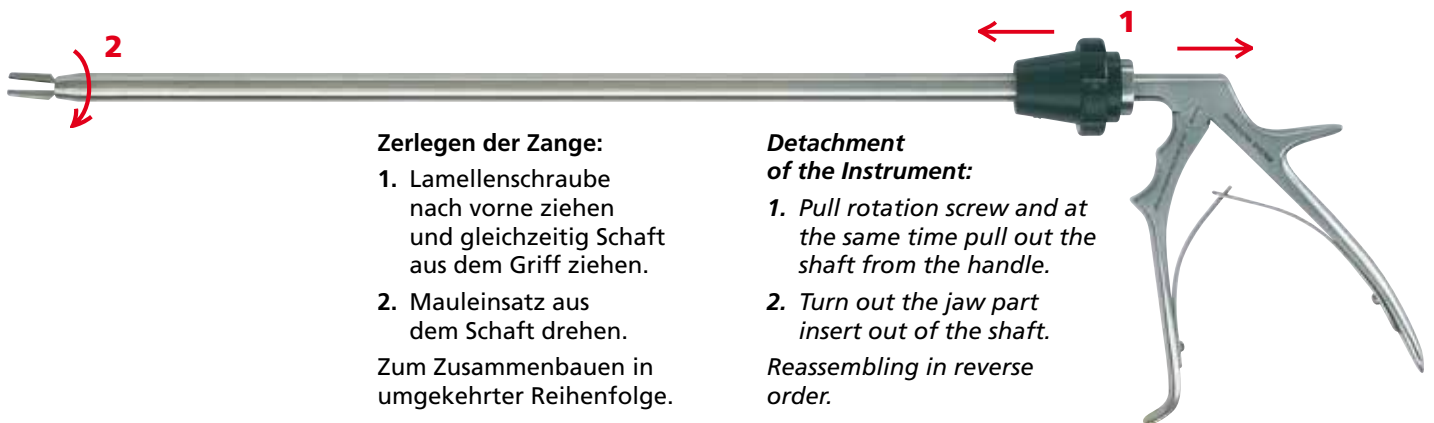

Trokarhülsen - Standard

Trocar Sleeves - standard

Automatik Trokarhülse mit Hahn,
Metallschaftrohr auswechselbar.
Gehäuse aus Messing verchromt,
Schaft aus Edelstahl

*Automatic trocar sleeve with stop-
cock, metal shaft exchangeable.
Housing - brass chromed,
shaft - stainless steel*

Automatik Trokarhülse mit Hahn,
manuelle Klappenöffnung,
Metallschaftrohr auswechselbar.
Komplett aus Edelstahl

*Automatic trocar sleeve with stop-
cock, manual trap door valve,
metal shaft exchangeable.
Completely stainless steel*



Ø mm	NL mm WL mm		
3,5	70,0	H80-036-00	H81-030-00
5,0	92,0	H80-056-00	H81-050-00
5,5	95,0	H80-0556-00	H81-0550-00
7,0	95,0	H80-076-00	H81-070-00
8,0	105,0	H80-086-00	-
10,0	97,0	H80-106-00	H81-100-00
11,0	101,0	H80-116-00	H81-110-00
12,5	98,0	H80-126-00	H81-120-00
13,0	97,0	-	H81-130-00
15,0	109,0	-	H81-150-00
20,0	118,0	-	H81-200-00
5,5	150,0	H80-0556-00S	H81-0550-00S
11,0	150,0	H80-116-00S	H81-110-00S
12,5	150,0	H80-126-00S	H81-120-00S

Schaftrohre einzeln

Shafts only

Metallschaftrohr
ohne Gewinde

*Metal Shaft
smooth*



A

Metallschaftrohr
mit Gewinde

*Metal Shaft
with thread*



B

Kunststoff-
schaftrohr
ohne Gewinde

*Plastic Shaft
smooth*



C

Kunststoff-
schaftrohr
mit Gewinde

*Plastic Shaft
with thread*



D

Schaft einzeln,
passend für Trokare
auf Seite 36

*Shaft only,
suitable for Trocars
on page 36*

Ø mm	NL mm WL mm	A	B	C	D
3,5	70	H80-035-A			
5,0	92	H80-050-A			
5,5	95	H80-055-A	H80-055-B	H80-055-C	H80-055-D
7,0	95	H80-070-A			
8,0	105	H80-080-A			
10,0	97	H80-100-A			
11,0	101	H80-110-A	H80-110-B	H80-110-C	H80-110-D
12,5	98	H80-125-A	H80-125-B	H80-125-C	H80-125-D
13,0	97	H80-130-A			
5,5	150	H80-055-AS			
11,0	150	H80-110-AS			
12,5	150	H80-125-AS			

Trocarhülsen mit verschiedenen Schäften

Trocar Sleeves with different Shafts



5,5	Standardversion siehe S. 36 <i>Standard version see page 36</i>	H80-0556-00B	H80-0556-00C	H80-0556-00D
11,0		H80-116-00B	H80-116-00C	H80-116-00D
12,5		H80-126-00B	H80-126-00C	H80-126-00D



5,5	Standardversion siehe S. 36 <i>Standard version see page 36</i>	H81-0550-00B	H81-0550-00C	H81-0550-00D
11,0		H81-110-00B	H81-110-00C	H81-110-00D
12,5		H81-120-00B	H81-120-00C	H81-120-00D

Trokarhülsen

Trocar Sleeves

Automatik Trokarhülse mit Hahn;
Edelstahl

- manuelle Klappenöffnung
- Gewichtsreduzierung
- Reduzierung der Gehäusegröße
- verbesserte Nutzlänge
- bessere Handhabung

*Automatic trocar sleeve with
stopcock; stainless steel*

- manual trap door valve
- reduced weight
- reduced size of the housing
- improved working length
- better handling

Automatik Trokarhülse mit Hahn

- Silikondichtung
- Gehäuse aus PPSU

*Automatic trocar sleeve with
stopcock*

- Silicone valve
- Housing made of PPSU



Ø mm	NL mm WL mm	Kennfarbe Colour Code		
5,5	103,0	weiß/white	H81-0055-00	H81-1055-00
11,0	105,0	blau/blue	H81-0110-00	H81-1110-00
13,0	102,0	grün/green	H81-0130-00	H81-1130-00
5,5	150,0	weiß/white	H81-0055-00S	H81-1055-00S
11,0	150,0	blau/blue	H81-0110-00S	H81-1110-00S
12,5	150,0	grün/green	H81-0130-00S	H81-1130-00S

Schaftrohre einzeln

Shafts only

Schaft einzeln,
passend für Trokare
auf Seite 38

Shaft only,
suitable for Trocars
on page 38

Metallschaftrohr
ohne Gewinde

*Metal Shaft
smooth*



A

Metallschaftrohr
mit Gewinde

*Metal Shaft
with thread*



B

Kunststoff-
schaftrohr
ohne Gewinde

*Plastic Shaft
smooth*



C

Kunststoff-
schaftrohr
mit Gewinde

*Plastic Shaft
with thread*



D

Ø mm NL mm
 WL mm

5,5		H81-055-A	H81-055-B	H81-055-C	H81-055-D
11,0		H81-110-A	H81-110-B	H81-110-C	H81-110-D
13,0		H81-130-A	H81-130-B	H81-130-C	H81-130-D
5,5	150	H81-055-AS			
11,0	150	H81-110-AS			
13,0	150	H81-130-AS			

Trokarhülsen mit verschiedenen Schäften

Trocar Sleeves with different Shafts

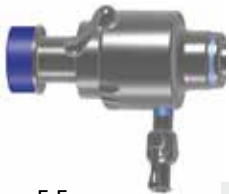

5,5
11,0
13,0

Standardversion siehe S. 38
*Standard version
see page 38*

H81-0055-00B
H81-0110-00B
H81-0130-00B

H81-0055-00C
H81-0110-00C
H81-0130-00C

H81-0055-00D
H81-0110-00D
H81-0130-00D



5,5
11,0
13,0

Standardversion siehe S. 38
*Standard version
see page 38*

H81-1055-00B
H81-1110-00B
H81-1130-00B

H81-1055-00C
H81-1110-00C
H81-1130-00C

H81-1055-00D
H81-1110-00D
H81-1130-00D

Trokare, Reduzierer
Trocars, Reducers

Trokar
konisch
*Trocar
conical*



Trokar
dreikant
*Trocar
pyramidal*



Trokar
stumpf,
Hasson
*Trocar blunt,
Hasson*



Trokar mit
Hohlschliff,
durchlässig,
dreikant
*Trocar, hollow
sharpened,
permeable,
pyramidal*



Sicherheitstroker,
feststellbar,
dreikant
*Safety Trocar,
fixable,
pyramidal*



Sicherheitstroker,
feststellbar,
halbmond
*Safety Trocar,
fixable,
half moon*

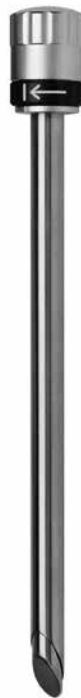

Ø mm

3,5	H80-035-02	H80-035-01	H80-035-07	-	-	-
5,0	H80-050-02	H80-050-01	H80-050-07	H80-050-08	H80-050-05	H80-050-06
5,5	H80-055-02	H80-055-01	H80-055-07	H80-055-08	H80-055-05	H80-055-06
7,0	H80-070-02	H80-070-01	-	-	-	-
8,0	H80-080-02	H80-080-01	-	H80-080-08	H80-080-05	H80-080-06
10,0	H80-100-02	H80-100-01	H80-100-07	H80-100-08	H80-100-05	H80-100-06
10,5	H80-105-02	H80-105-01	-	-	-	-
11,0	H80-110-02	H80-110-01	H80-110-07	H80-110-08	H80-110-05	H80-110-06
12,5	H80-120-02	H80-120-01	H80-120-07	H80-120-08	H80-120-05	H80-120-06
13,0	H80-130-02	H80-130-01	-	H80-130-08	H80-130-05	-
15,0	H80-150-02	H80-150-01	-	-	-	-
20,0	H80-200-02	H80-200-01	-	-	-	-
5,5 *	H80-055-02S	H80-055-01S	-	H80-055-08S	H80-055-05S	-
11,0 *	H80-110-02S	H80-110-01S	-	H80-110-08S	H80-110-05S	-
12,5 *	H80-120-02S	H80-120-01S	-	H80-120-08S	H80-120-05S	-

* passend für Trokarhülse mit Nutzlänge 150mm / * fitting to trocar sleeve with working length 150mm

Hasson-Konus
fixierbar
mit Fadenhalter
*Hasson-cone
fixable with
suture holders*

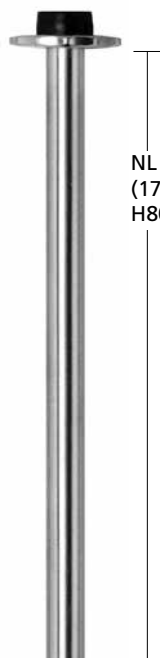

NL / WL 190 mm
(175 mm for
H80-000-19)

Ø mm

3,5	H80-035-K
5,5	H80-055-K
10,0	H80-100-K
11,0	H80-110-K
12,5	H80-125-K
13,0	H80-130-K

Baukastensystem
Construction Set

Reduzierbuchse
Reducer sleeve



Reduzierer mit
Silikonlasche
*Reducer
with silicon clip*





Klappenreduzierer
Flap reducer



Ø mm				
5,0 - 4,0	H80-000-19	-	-	-
5,5 - 3,0	H80-305-00	H80-305-05	-	-
10,0 - 5,5	H80-510-00	H80-510-05	H80-510-14	H80-512-12
11,0 - 5,5	-	H80-511-05	H80-511-14	H80-512-12
12,5 - 5,5	H80-512-00	H80-512-05	H80-512-14	H80-512-12
12,5 - 8,0	-	-	-	-
12,5 - 10,0	H80-1012-00	H80-1012-05	H80-1012-14	H80-1012-12
13,0 - 5,5	-	H80-513-05	H80-513-14	H80-512-12
13,0 - 10,5	-	H80-1013-05	H80-1013-14	H80-1012-12
15,0 - 5,5	H80-515-00	-	-	-
15,0 - 10,0	H80-1015-00	-	-	-
20,0 - 5,5	H80-520-00	-	-	-
20,0 - 10,0	H80-1020-00	-	-	-
20,0 - 15,0	H80-1520-00	-	-	-
13,0 - 10,0	-	H80-1013-05	H80-1013-14	-

Dichtungen Sealings

für Trokarhülse <i>for Trocar sleeve</i>					
	Ø	Dichtkappe <i>Sealing cap</i>	Ø Loch <i>Ø hole</i>	O-Ring <i>O-Ring</i>	Innendichtung <i>inner Sealing</i>
H80-036-00	3,5	H80-900-03 ●	2	H80-901-03	H80-902-03 ●
H80-056-00	5,0	H80-900-05 ●	4	H80-901-05	H80-902-05 ●
H80-0556-00	5,5	H80-900-05 ●	4	H80-901-05	H80-902-05 ●
H80-076-00	7,0	H80-900-07 ●	6	H80-901-05	H80-902-05 ●
H80-086-00	8,0	H80-900-08 ●	7	H80-901-05	H80-902-05 ●
H80-106-00	10,0	H80-900-10 ●	8	H80-901-10	H80-902-10 ●
H80-116-00	11,0	H80-900-10 ●	8	H80-901-11	H80-902-10 ●
H80-126-00	12,5	H80-900-12 ●	11	H80-901-12	H80-902-10 ●
H80-556-00S	5,5	H80-900-05 ●	4	H80-901-05	H80-902-05 ●
H80-116-00S	11,0	H80-900-10 ●	8	H80-901-11	H80-902-10 ●
H80-126-00S	12,5	H80-900-12 ●	11	H80-901-12	H80-902-10 ●
H81-030-00	3,5	H80-900-03 ●	2	H80-901-03	H80-902-03 ●
H81-050-00	5,0	H80-900-05 ●	4	H81-050-B	H80-902-05 ●
H81-0550-00	5,5	H80-900-05 ●	4	H81-050-B	H80-902-05 ●
H81-070-00	7,0	H80-900-07 ●	6	H81-050-B	H80-902-05 ●
H81-100-00	10,0	H80-900-10 ●	8	H80-901-11	H80-902-10 ●
H81-110-00	11,0	H80-900-10 ●	8	H80-901-11	H80-902-10 ●
H81-120-00	12,5	H80-900-12 ●	11	H80-901-11	H80-902-10 ●
H81-130-00	13,0	H80-900-13 ●	10	H80-901-11	H80-902-10 ●
H81-150-00	15,0	H80-900-15 ●	13	H80-901-15	H80-902-15 ●
H81-200-00	20,0	H80-900-20 ●	18	H80-901-20	H80-902-20 ●
H81-0550-00S	5,5	H80-900-05 ●	4	H81-050-B	H80-902-05 ●
H81-110-00S	11,0	H80-900-10 ●	8	H80-901-11	H80-902-10 ●
H81-120-00S	12,5	H80-900-12 ●	11	H80-901-11	H80-902-10 ●
H81-055-00	5,5	H80-900-55 ○	4	H80-901-06	H80-902-06 ○
H81-0110-00	11,0	H80-900-10 ●	8	H81-050-B	H80-902-11 ●
H81-0130-00	13,0	H80-900-13 ●	10	H81-050-B	H80-902-13 ●
H81-0055-00S	5,5	H80-900-55 ○	4	H80-901-06	H80-902-06 ○
H81-0110-00S	11,0	H80-900-10 ●	8	H81-050-B	H80-902-11 ●
H81-0130-00S	13,0	H80-900-13 ●	10	H81-050-B	H80-902-13 ●
Silikondichtung / <i>Silicon Sealing</i>					
H81-1055-00	5,5	H80-900-55 ○	4	H80-903-03	
H81-1110-00	11,0	H80-900-10 ●	8	H80-903-10	
H81-1130-00	13,0	H80-900-13 ●	10	H80-903-10	
H81-1055-00	5,5	H80-900-55 ○	4	H80-903-03	
H81-1110-00	11,0	H80-900-10 ●	8	H80-903-10	
H81-1130-00	13,0	H80-900-13 ●	10	H80-903-10	

Insufflationskanülen Insufflation Needles

Veress Insufflationskanüle
(Ø 2,0 mm), Luer-Lock

*Veress Insufflation needle
(Ø 2,0 mm), Luer-Lock*

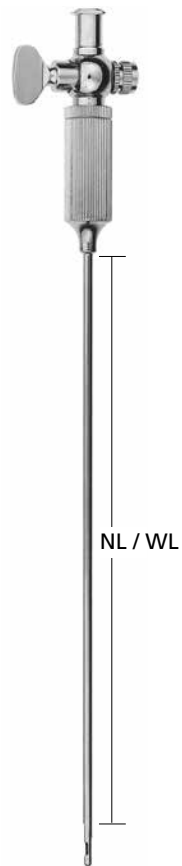

Veress "High Flow"
Insufflationskanüle
(Ø 2,7 mm), Luer-Lock

*Veress "High Flow" Insufflation
needle (Ø 2,7 mm) Luer-Lock*



NL mm
WL mm

55	H80-205-00	-
70	H80-207-00	-
80	H80-208-00	-
100	H80-210-00	H80-210-20
120	H80-212-00	H80-212-20
130	H80-213-00	-
140	H80-214-00	-
150	H80-215-00	H80-215-20
170	H80-217-00	H80-217-20
180	H80-218-00	-
200	H80-220-00	-
230	H80-223-00	-

Zubehör Laparoskopie
Accessories Laparoscopy



Leberelevator
Spülanschluß, 3 Finger
Fan Retractor
irrigation system, 3 fingers

Ø 5 x 330 mm	gerade / straight	H80-534-04
Ø 5 x 330 mm	Spitze gebogen / tip curved	H80-534-05
Ø 5 x 330 mm	abwinkelbar / angled	H80-533-06
Ø 5 x 330 mm	abwinkelbar, Spitze gebogen angled, tip curved	H80-533-07



Leberelevator
Spülanschluß, 5 Finger
Fan Retractor
irrigation system, 5 fingers

Ø 10 x 340 mm	gerade / straight	H80-136-04
Ø 10 x 340 mm	Spitze gebogen / tip curved	H80-136-05
Ø 10 x 340 mm	abwinkelbar / angled	H80-134-06
Ø 10 x 340 mm	abwinkelbar, Spitze gebogen angled, tip curved	H80-134-07

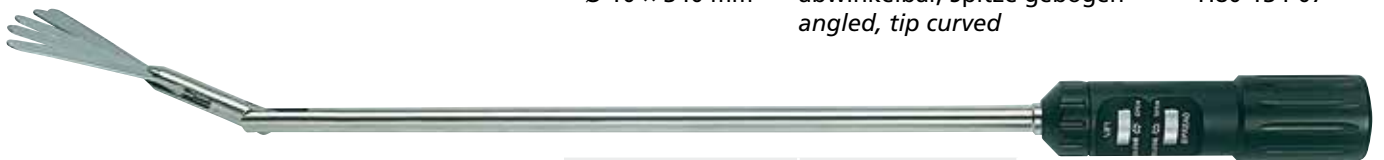

Leberelevator
zerlegbar, schwenkbar,
spreizbar, 5 Finger
Fan Retractor
detachable, horizontally and
vertically adjustable, 5 fingers

Ø 10 x 380 mm	H80-133-02
Ø 10 x 480 mm	H80-145-02

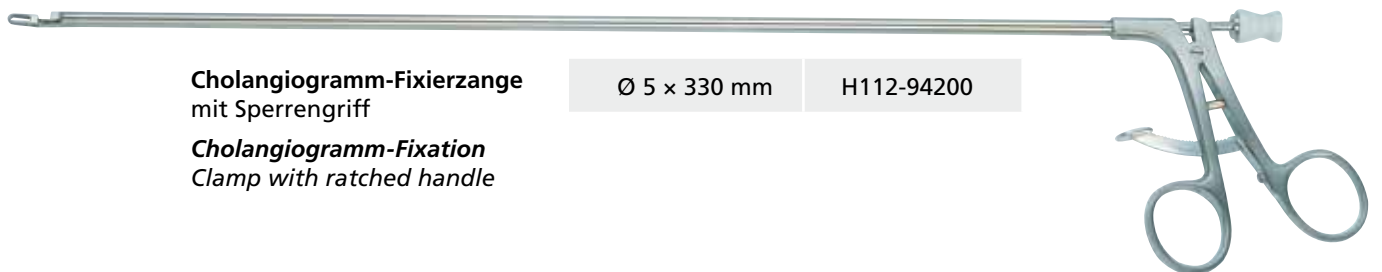

Cholangiogramm-Fixierzange
mit Sperrgriff
Cholangiogramm-Fixation
Clamp with ratched handle

Ø 5 x 330 mm	H112-94200
--------------	------------

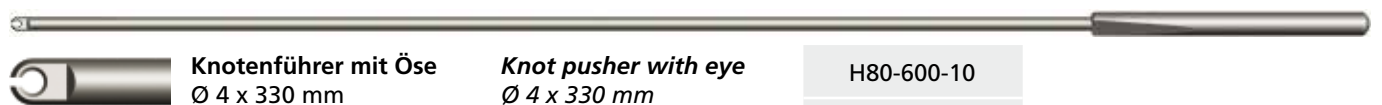

Knotenführer mit Öse
Ø 4 x 330 mm
Ø 4 x 450 mm

Knot pusher with eye
Ø 4 x 330 mm
Ø 4 x 450 mm

H80-600-10
H80-600-11

Fascia-Nähhilfe
Ø 2,3 x 140 mm

Fascia closure device
Ø 2,3 x 140 mm

H80-620-23

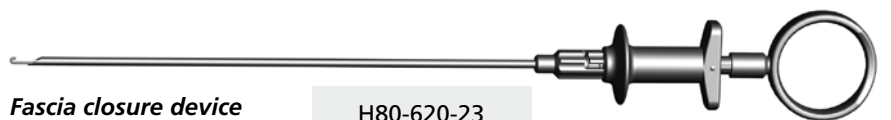

Saug- / Spülsysteme Suction- / Irrigationsystems

Griff mit Luer-Lock Anschluß,
Trompetenventil
*Handle with Luer-Lock connection,
trumpet valve*



H80-000-20

Griff mit Schlauchanschluß,
Schiebeventil
*Handle with tube connection,
sliding valve*



H80-000-21

Griff mit Schlauchanschluß,
Trompetenventil
*Handle with tube connection,
trumpet valve*



H80-000-18

Griff mit großem Schlauchanschluß,
Trompetenventil
*Handle with big tube connection,
trumpet valve*

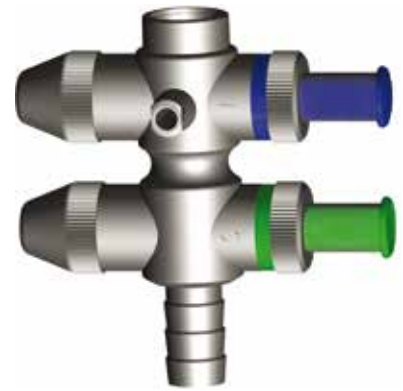

H80-133-10

Bohrungen Holes

Ø 2,8 × 250 mm	8	H80-000-10	
Ø 2,8 × 330 mm	8	H80-000-12	
Ø 5,0 × 330 mm	4	H80-000-22	
Ø 5,0 × 330 mm	48	H80-000-23	
Ø 5,0 × 330 mm	12	H80-000-24	
Ø 5,0 × 330 mm	48	H80-000-25	
Ø 5,0 × 500 mm	48	H80-000-26	
Ø 5,0 × 330 mm		H80-000-27	
Ø 5,0 × 330 mm		H80-000-28	

Bohrungen Holes

32	Ø 10 × 330 mm	H80-133-11	
16	Ø 5,0 × 330 mm	H80-133-12	
16	Ø 3,5 × 240 mm	H80-133-13	

**Saug- / Spülsysteme
2 in 1 - System**

**Suction- / Irrigation systems
2 in 1 - System**

Griff mit einem Trompetenventil und drehbarem Elektrodenadapter, kombinierter Luer-Lock- / Schlauchanschluss, seitlicher HF-Anschluß; zu verwenden mit Elektroden auf Seite 47.

Handle with single trumpet valve, rotatable adapter for electrodes, combined Luer-Lock / tube connection, sidewise HF-connection; to use with electrodes on page 47.



H80-000-51

Griff mit Schiebeventil und drehbarem Elektrodenadapter, kombinierter Luer-Lock-/Schlauchanschluss, seitlicher HF-Anschluß; zu verwenden mit Elektroden auf Seite 47.

Handle with sliding valve, rotatable adapter for electrodes, combined Luer-Lock/tube connections, sidewise HF-connection; to use with electrodes on page 47.



H80-000-52

**2 in 1 System,
Saug-Spülen und monopolares Koagulieren**

**2 in 1 System,
Suction-Irrigation and monopolar coagulation**



Pistolengriff <i>Pistol-Handle</i>	H80-000-30
---------------------------------------	------------

Möglichkeiten:

1. Pistolengriff + Saug-Spül-Rohre
2. Pistolengriff + Adapter + monopolare Elektroden

Possibilities:

1. *Pistol-Handle + Suction/Irrigation Tubes*
2. *Pistol-Handle + connector + monopolar electrodes*



Adapter für Elektroden <i>Connector for electrodes</i>	H80-000-34
---	------------

Saug-/Spülrohre
für Griff H80-000-30

*Suction-Irrigation Tubes
for handle H80-000-30*

	Bohrungen <i>Holes</i>	
Ø 3,0 × 330 mm	16	H80-000-31
Ø 5,0 × 330 mm	16	H80-000-32
Ø 10 × 330 mm	32	H80-000-33



Monopolare Elektroden mit Absaugung, 360° drehbar
für Griff H80-000-30, H80-000-51 und H80-000-52

*Monopolar electrodes with suction tube, 360° rotatable
for handle H80-000-30, H80-000-51 and H80-000-52*

Ø 5 × 330 mm	H80-000-35
Ø 5 × 330 mm	H80-000-36
Ø 5 × 330 mm	H80-000-37
Ø 5 × 330 mm	H80-000-38
Ø 5 × 330 mm	H80-000-39



**Elektroden
und Kabel**
*Electrodes
and Cables*







Monopolar-Elektrode mit Keramik, ohne Absaugung, vollisoliert, 4 mm Stecker, für HF- und RF-Generatoren geeignet

Monopolar-electrode with ceramic without suction, fully insulated, 4 mm plug, applicable for HF- and RF-generators

Monopolar-Elektrode mit Keramik und Absaugung, vollisoliert, 4 mm Stecker, für HF- und RF-Generatoren geeignet

Monopolar-electrode with ceramic and suction, fully insulated, 4 mm plug, applicable for HF- and RF-generators



Knopfelektrode <i>Button electrode</i>		Ø 3,0 × 295 mm Ø 5,0 × 330 mm Ø 5,0 × 450 mm	H70-333-100 H70-533-100 H70-545-100	- - -
Rundhakenlektrode <i>Dissection hook electrode</i>		Ø 3,0 × 295 mm Ø 5,0 × 330 mm Ø 5,0 × 450 mm	H70-333-101 H70-533-101 H70-545-101	- H70-533-141 H70-545-141
Hakenlektrode 90° <i>Dissection hook electrode, right angled</i>		Ø 3,0 × 295 mm Ø 5,0 × 330 mm Ø 5,0 × 450 mm	H70-333-102 H70-533-102 H70-545-102	- H70-533-142 H70-545-142
Spatelektrode <i>Dissection spatula electrode</i>		Ø 3,0 × 295 mm Ø 5,0 × 330 mm Ø 5,0 × 450 mm	- H70-533-103 H70-545-103	- H70-533-143 H70-545-143
Nadelelektrode <i>Needle electrode</i>		Ø 3,0 × 295 mm Ø 5,0 × 330 mm Ø 5,0 × 450 mm	- - -	- - -
Griff für geschlossene Elektroden <i>Handle for electrodes without suction</i>			-	-

Monopolar-Elektrode
ohne Absaugung,
vollisoliert,
4 mm Stecker.

*Monopolar-electrode
without suction,
fully insulated,
4 mm plug.*





Monopolar-Elektrode
mit Lueranschluß,
vollisoliert,
4 mm Stecker.

*Monopolar-electrode
with Luer-Lock
connection,
fully insulated,
4 mm plug.*







Monopolarsauger
mit Trompetenventil,
vollisoliert,
4 mm Stecker.

*Monopolar suction unit
with trumpet valve,
fully insulated,
4 mm plug.*



	Ø 3,0 × 295 mm Ø 5,0 × 330 mm Ø 5,0 × 450 mm	H70-333-110 H70-533-110 H70-545-110	- H70-533-120 H70-545-120	- H70-533-130 H70-545-130
	Ø 3,0 × 295 mm Ø 5,0 × 330 mm Ø 5,0 × 450 mm	H70-333-111 H70-533-111 H70-545-111	- H70-533-121 H70-545-121	- H70-533-131 H70-545-131
	Ø 3,0 × 295 mm Ø 5,0 × 330 mm Ø 5,0 × 450 mm	H70-333-112 H70-533-112 H70-545-112	- H70-533-122 H70-545-122	- H70-533-132 H70-545-132
	Ø 3,0 × 295 mm Ø 5,0 × 330 mm Ø 5,0 × 450 mm	H70-333-113 H70-533-113 H70-545-113	- H70-533-123 H70-545-123	- H70-533-133 H70-545-133
	Ø 3,0 × 295 mm Ø 5,0 × 330 mm Ø 5,0 × 450 mm	H70-333-114 H70-533-114 H70-545-114	- H70-533-124 H70-545-124	- H70-533-134 H70-545-134
		H70-533-000	-	-

Monopolare Anschlusskabel Monopolar connecting cables

	3 m	5 m	Instrumentenseite	Geräteseite
Hermann 4 mm	H98-903-030	H98-903-050		
Valleylab	H98-903-035	H98-903-055		
Erbe ICC/ACC	H70-300-005	H70-500-005		

Sonstiges
Others

Applikator
für Endo-Naht
*Applicator
for Endo-Ligature*

Taststab,
graduiert
*Palpation Probe,
graduated*

Saug-/Spülkanüle
mit Laserführung,
2 Trompetenventile,
Vierkantgriff
*Suction-Irrigation
Tube with central
Tube for Laser Fibre*

Punktions-/
Injektionskanüle,
Luer-Lock Anschluß,
Nadellänge 20 mm
*Punction-/
Injection Needle, Luer-
Lock connection,
length of needle 20 mm*

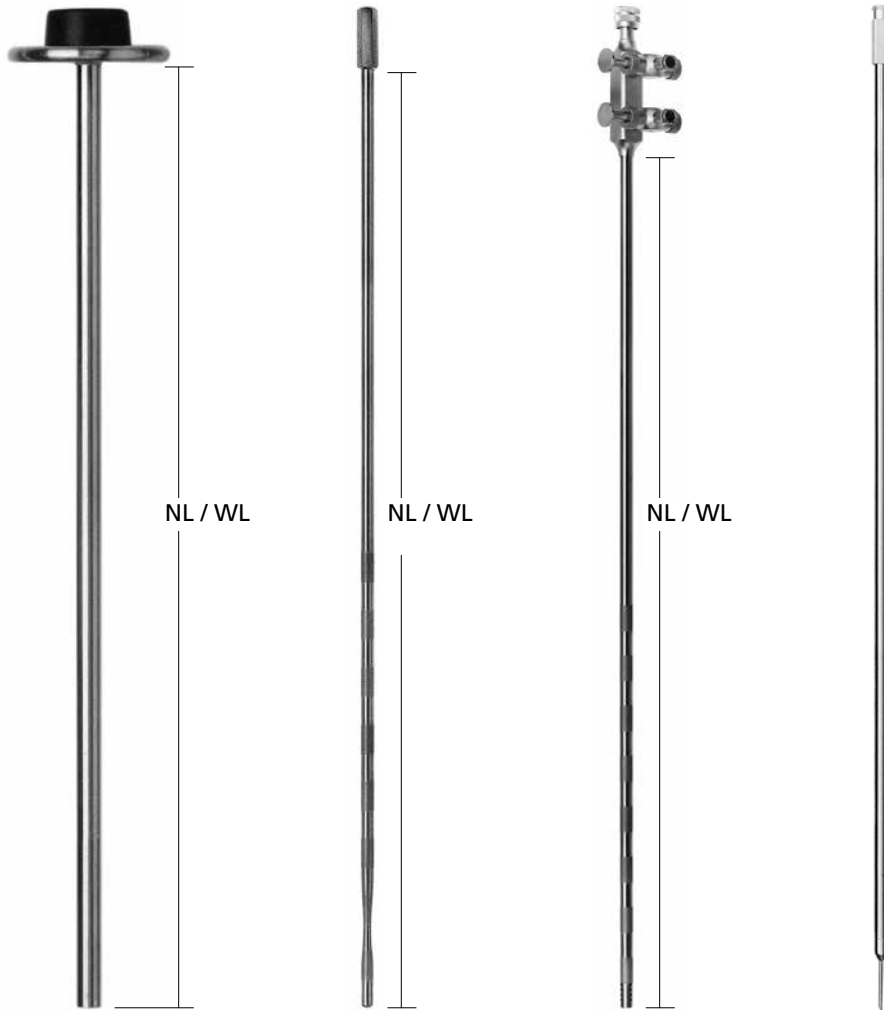

Ø mm	NL mm WL mm					Nadel-Ø mm Needle-Ø mm
4-5	175	H80-000-19	-	-	-	
2,8	250	-	H80-325-12	H80-325-15*	-	
5	300	-	H80-530-12	-	-	
2,8	330	-	H80-333-12	H80-333-15*	H80-333-18	1,2
5	330	-	H80-533-12	-	H80-530-18	1,4
5	340	-	-	H80-533-15	-	
5	400	-	H80-540-12	-	-	
5	450	-	H80-545-12	-	H80-545-18	1,4

*nicht mit Laserführung
*without laser guide

Einsteichdorn
Thorn for rinsing
bottle



NL mm
WL mm

235	H94-000-060
190	H94-000-061
160	H94-000-062

Dilatationssatz
Dilatation Set



Ø von - auf mm
Ø from - to mm

5 - 10	H80-510-11
5 - 11	H80-511-11
10 - 15	H80-1015-11
5 - 15	H80-515-11
10 - 20	H80-1020-11
5 - 20	H80-520-11

Saug-Spülkanüle mit Hahn,
Luer-Lock Anschluß,
graduiert, 16 Bohrungen

Suction/Irrigation tube
with stopcock,
Luer-Lock connection,
graduated, 16 holes



NL / WL
330 mm

Ø mm NL mm
WL mm

5	330	H80-533-17
5	450	H80-545-17

S-Retraktor (Paar)
S-retractor (pair)



Ø mm

5,5	H80-650-01
11	H80-650-02

Bipolare Koagulation
Bipolar Coagulation

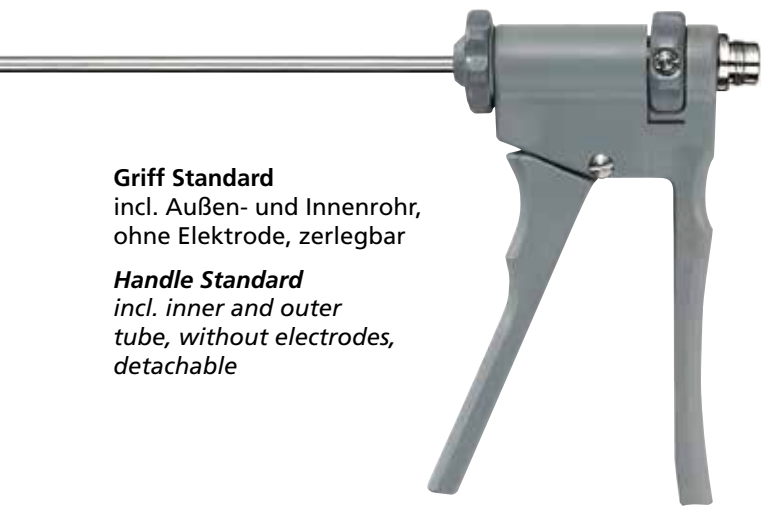

Griff Standard
incl. Außen- und Innenrohr,
ohne Elektrode, zerlegbar

Handle Standard
incl. inner and outer
tube, without electrodes,
detachable

Ø mm	Länge mm Length mm	
3	340	H855-30000
5	340	H855-00000
5	450	H855-00005
5	200	H855-00050









Ringgriff
incl. Außen- und
Innenrohr, ohne
Elektrode, zerlegbar

Ring Handle
incl. inner and outer
tube, without
electrodes,
detachable

Ø mm	Länge mm Length mm	
3	340	H855-30001
5	340	H855-10000
5	450	H855-10005
5	200	H855-10050







Elektroden für Koagulationszangen S. 54

Electrodes for Coagulation forceps page 54

		Ø 3 x 340 mm	Ø 5 x 340 mm	Ø 5 x 450 mm	Ø 5 x 200 mm
	Gewellter Steg <i>Rippled bar</i>	H855-30010	H855-10010	H855-10020	H855-10060
	Pinzettenspitze, 1mm <i>Fluted bit, 1mm</i>	H855-30011	H855-10011	H855-10021	H855-10061
	Kleppinger, gerieft <i>Kleppinger, serrated</i>	-	H855-10013	H855-10023	H855-10063
	Zangenart, Maul 3 mm <i>Tong-type bit, 3 mm</i>	-	H855-10015	H855-10025	H855-10065
	Schere, gebogen <i>Scissors, curved</i>	-	H855-10017	H855-10027	H855-10067
	Schere mit Hartmetallschneide, gebogen <i>Scissors with TC blades, curved</i>	-	H855-10018	H855-10028	H855-10068
	Dissektor Maryland, gebogen <i>Dissector Maryland, curved</i>	-	H855-10019	H855-10029	H855-10069

Anschlußkabel für Koagulationszangen S. 54

Cables for Coagulation Forceps page 54

Geräteseite <i>Generator side</i>	Instrumentenseite <i>Instrument side</i>		
	Ø 3 mm, 3m	Ø 5 mm, 3m	
	2-Bananenstecker (entspricht nicht EU-Bestimmungen) <i>2 Banana-plug (not conform to EU-regulations)</i>	H855-30100	H855-00104
	U20	H855-30110	H855-00106
	Valleylab / Hermann	H855-30101	H855-00105
	Martin	H855-30102	H855-00102
	Erbe	H855-30103	H855-00103
	Adapterstecker zu verwenden mit bipolarem Flachstecker-Kabel <i>Adapter plug to use with bipolar flat plug cables</i>		H855-00400

Bipolare Koagulation Bipolar Coagulation

Ringgriff aktiv inkl. Schaft
Ring Handle active incl. shaft

Ø mm	Länge mm Length mm	
5	340	H824-10001





Elektroden für Ringgriff aktiv

Electrodes for Ring Handle active Ø 5 x 340 mm

	Große Faßzange <i>Large grasping forceps</i>	H824-00010
	Schere, gebogen <i>Scissors, curved</i>	H824-00018
	Dissektor Maryland, gebogen <i>Dissector Maryland, curved</i>	H824-00019
	Pinzette, gebogen <i>Forceps, curved</i>	H824-00011
	Fasszange, gebogen <i>Grasping forceps, curved</i>	H824-00015
	Delta Faßzange, gebogen <i>Delta Forceps, curved</i>	H824-00014





Bipolare Haken und Nadeln

Bipolar Hooks and Needles Ø 3 mm

	Bipolarer L-Haken <i>Bipolar L-Hook</i>	H856-30200
	Bipolarer V-Haken <i>Bipolar V-Hook</i>	H856-30700
	Bipolare Nadel <i>Bipolar Needle</i>	H856-30600

Bipolare Flachstecker-Kabel

Bipolar flat plug cables 3 m 5 m

	2 Bananenstecker, entspricht nicht EU-Bestimmungen <i>2 Banana-Plug, non-compliant with EU-standards</i>	H801-00010	H801-00013
	U20	H801-00260	(4 m)
	Erbe <i>Erbe</i>	H801-00017	H801-00018
	Martin, Berchtold, Aesculap GK55, GK60 <i>Martin, Berchtold, Aesculap GK55, GK60</i>	H801-00019	H801-00020
	Valleylab, Lamidey, EMC <i>Valleylab, Lamidey, EMC</i>	H801-00021	H801-00022



HD Laparoscope

HD Laparoscopes

Ø mm	Blickrichtung Direction of view	Arbeitslänge working lengths mm	
10,0	0°	310	H83-100-000
10,0	30°	310	H83-100-030
10,0	45°	310	H83-100-045
5,0	0°	300	H83-050-000
5,0	30°	300	H83-050-030
5,0	45°	300	H83-050-045
3,0	0°	300	H83-030-000
3,0	30°	300	H83-030-030

4K Laparoscope

4K Laparoscopes

Ø mm	Blickrichtung Direction of view	Arbeitslänge working lengths mm	
10,0	0°	310	H83-103-000
10,0	30°	310	H83-103-030
10,0	45°	310	H83-103-045
5,0	0°	300	H83-053-000
5,0	30°	300	H83-053-030
5,0	45°	300	H83-053-045

Lichtleitkabel inkl. Adapter

Autoklavierbar, hochflexibel und zugfest

Cold Light Cable incl. adapter

Autoclavable, high flexibility and tensile strength

Ø mm	Länge Length mm	
3,5	1800	H91-180-035
3,5	2300	H91-230-035
3,5	3000	H91-300-035
4,8	1800	H91-180-045
4,8	2300	H91-230-045
4,8	3000	H91-300-045

Diese Kabel sind auch in den Farben blau, grün, gelb und rot erhältlich. Bitte in diesen Fällen die Farbe hinter die Artikelnummer schreiben.

These cables are also available in blue, green, yellow and red - just mention colour behind reference number.

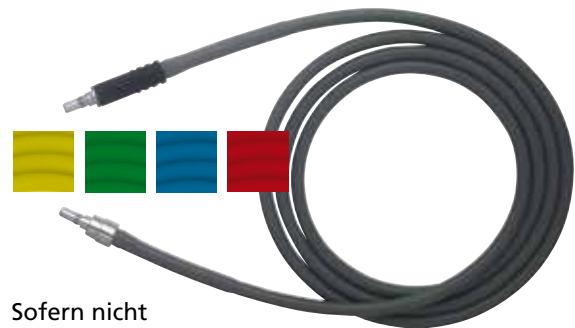

Sofern nicht anders vermerkt, liefern wir passend zu STORZ-Anschluß. Lichtleitkabel auch für Xenon-Lampen 300 W geeignet. Weitere Adapter verfügbar. Siehe Katalog "Endoscopic Units".

If not stated differently we supply fitting to STORZ connection. Light guides as well appropriate for Xenon lamps 300 W. Further adapters available. Please see our catalog "Endoscopic Units".



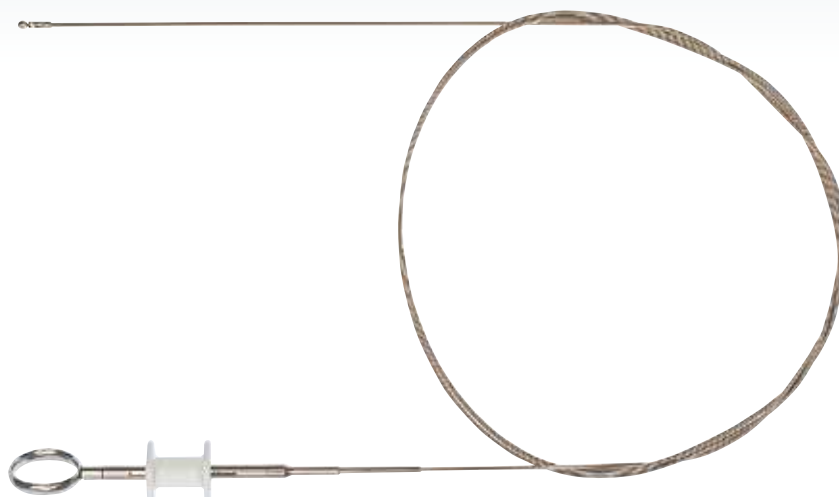





Flexible Biopsie-Zangen mit Fenster
Flexible Biopsy Forceps, fenestrated



	Ø mm	100 cm	150 cm	180 cm	220 cm
Biopsie-Zange, runder Löffel <i>Biopsy Forceps, round cup</i>	1,8	H8-1810-80	H8-1815-80	H8-1818-80	H8-1822-80
	2,2	H8-2210-80	H8-2215-80	H8-2218-80	H8-2222-80
	3,5	H8-3410-80	H8-3415-80	H8-3418-80	H8-3422-80
Biopsie-Zange mit Dorn, runder Löffel <i>Biopsy Forceps with thorn, round cup</i>	1,8	H8-1810-81	H8-1815-81	H8-1818-81	H8-1822-81
	2,2	H8-2210-81	H8-2215-81	H8-2218-81	H8-2222-81
	3,5	H8-3410-81	H8-3415-81	H8-3418-81	H8-3422-81
Biopsie-Zange, ovaler Löffel <i>Biopsy Forceps, oval cup</i>	1,8	H8-1810-82	H8-1815-82	H8-1818-82	H8-1822-82
	2,2	H8-2210-82	H8-2215-82	H8-2218-82	H8-2222-82
	2,6	H8-2610-82	H8-2615-82	H8-2618-82	H8-2622-82
	3,0	H8-3010-82	H8-3015-82	H8-3018-82	H8-3022-82
Biopsie-Zange mit Dorn, ovaler Löffel <i>Biopsy Forceps with thorn, oval cup</i>	1,8	H8-1810-83	H8-1815-83	H8-1818-83	H8-1822-83
	2,2	H8-2210-83	H8-2215-83	H8-2218-83	H8-2222-83
	2,6	H8-2610-83	H8-2615-83	H8-2618-83	H8-2622-83
	3,0	H8-3010-83	H8-3015-83	H8-3018-83	H8-3022-83

Flexible Faßzangen

Flexible Grasping Forceps

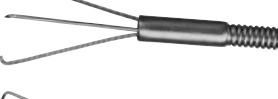
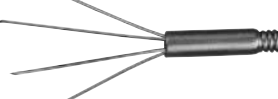
		Ø mm	100 cm	150 cm	180 cm	220 cm
Hechtmaul, voll <i>Jack mouth, full</i>		1,8	H8-1810-86	H8-1815-86	H8-1818-86	H8-1822-86
		2,2	H8-2210-86	H8-2215-86	H8-2218-86	H8-2222-86
Hechtmaul, hohl <i>Jack mouth, hollow</i>		1,8	H8-1810-84	H8-1815-84	H8-1818-84	H8-1822-84
		2,2	H8-2210-84	H8-2215-84	H8-2218-84	H8-2222-84
Faßzange, 1 x 2 Zähne <i>Grasping Forceps, 1 x 2 teeth</i>		2,6	-	H8-2615-84	-	H8-2622-84
Hechtmaul mit Längs- und Querzähnen <i>Jack mouth with teeth length- and cross wise</i>		1,8	H8-1810-74	H8-1815-74	H8-1818-74	H8-1822-74
		2,2	H8-2210-74	H8-2215-74	H8-2218-74	H8-2222-74
Fadenstanze <i>Punch for threads</i>		2,2	H8-2210-88	H8-2215-88	H8-2218-88	H8-2222-88
<hr/>						
		Ø mm	100 cm	150 cm	180 cm	220 cm
Faßzange, 1 x 2 Zähne <i>Grasping Forceps, 1 x 2 teeth</i>		1,8	H8-1810-90	H8-1815-90	H8-1818-90	H8-1822-90
		2,2	H8-2210-90	H8-2215-90	H8-2218-90	H8-2222-90
Faßzange, 2 x 2 Zähne <i>Grasping Forceps, 2 x 2 teeth</i>		1,8	H8-1810-91	H8-1815-91	H8-1818-91	H8-1822-91
		2,2	H8-2210-91	H8-2215-91	H8-2218-91	H8-2222-91
Faßzange, gezahnt <i>Grasping Forceps, serrated</i>		1,8	H8-1810-981	H8-1815-981	H8-1818-981	H8-1822-981
		2,2	H8-2210-981	H8-2215-981	H8-2218-981	H8-2222-981
3-armiger Greifer <i>Forceps with 3 nails</i>		1,8	H8-1810-92	H8-1815-92	H8-1818-92	H8-1822-92
		2,2	H8-2210-92	H8-2215-92	H8-2218-92	H8-2222-92
4-armiger Greifer <i>Forceps with 4 nails</i>		2,2	H8-2210-93	H8-2215-93	H8-2218-93	H8-2222-93
Polypen-Greifer <i>Polypotome tripped type</i>		2,2	H8-2210-94	H8-2215-94	H8-2218-94	H8-2222-94

Reinigung und Pflege Cleaning and care

ACHTUNG:

Bitte unbedingt die Gebrauchsanweisungen, welche wir unseren Produkten beilegen, beachten.

ATTENTION:

Please pay attention to our instructions for use which will be supplied together with our products.

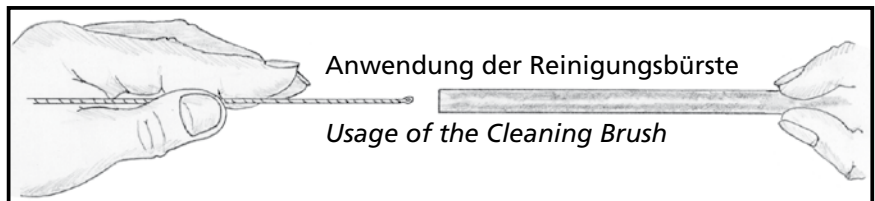

Anwendung der Reinigungsbürsten

Reinigen der Schäfte mit der
Reinigungsbürste:

Instrument zerlegen

Reinigungsbürste mit dem
metallenen Ende, an welchem sich
die Öse befindet, in den Schaft
einführen

Die Öse der Bürste auf der anderen
Seite des Schaftes fassen und
durchziehen

Vorgang ggf. wiederholen

**Die Bürste nicht in entgegengesetzte
Richtung (mit den Borsten voran) in
den Schaft drücken!**

Usage of the Cleaning Brush

Cleaning of the shaft with the
cleaning brush:

Detach the instrument

Put the cleaning brush into the
shaft (metal end with loop first!)

Grasp the metal end with loop on
the other side of the shaft and pull
the entire cleaning brush through
the shaft

Repeat the procedure if necessary

**Do not push the head with the
bristles through first!**



Reinigungsbürste
Cleaning Brush

Ø 5 mm x 40 cm H80-540-01
Ø 10 mm x 40 cm H80-140-01



Reinigungsaufsatz
Cleaning adapter

H 00-300-000



Wasserstrahl-
Reinigungspistole
komplett mit
9 Aufsätzen

Water Jet Cleaning Pistol
complete with 9 tips

H 80-990-00



Behälter für Optiken und Instrumente

zur Sterilisation und Aufbewahrung

Cases for scopes and instruments

for sterilization and storage

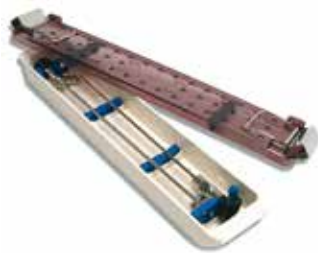

Behälter für Endoskope (Kunststoff) passend für 2 Endoskope Ø 1 - 10 mm

Tray for endoscopes (plastic) hold 2 endoscopes Ø 1 - 10 mm

Maße / size

39,4 x 7 x 3,5 cm

H188-99002

45,7 x 7 x 3,5 cm

H188-99003



Behälter für Endoskope und Lichtleitkabel (Kunststoff)

passend für bis zu 3 Endoskope Ø 2,7 - 10 mm und 1 Lichtleitkabel

Tray for endoscopes and light cable (plastic) holds up to 3 endoscopes Ø 2,7 - 10 mm and 1 light cable

Maße / size

46,5 x 21,2 x 5,1 cm

H188-99010



Siebkorb für Endoskope und Lichtleitkabel (Edelstahl)

passend für 1 Endoskop und 1 Lichtleitkabel

Basket for endoscope and light cable (stainless steel) holds 1 scope and 1 light cable

Maße / size

48 x 15 x 8 cm

H188-99020

Behälter für laparoskopische Instrumente

Laparoscopic instruments holding kit



System komplett

Set complete

bestehend aus / consisting of:

H188-98010

Container / Container
60 x 30 x 21 cm

H188-70110

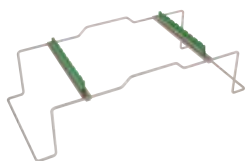

Rahmen mit Instrumentenhalterung Ø 5 und 10 mm
Frame with instrument holders Ø 5 und 10 mm

H188-79540

Siebkorb / Basket
54 x 24 x 7 cm

H188-75220



Silikonmatte / Silicone mat

H188-79527

***To complete the
Laparoscopy System***

*please see our special catalogue
for devices: Endoscopic Units*



**Endoscopic
Units**

Advanced units
for endoscopic surgery

Complete product range

OUR TRADITION:

- INNOVATION
- PRECISION
- SERVICE

HERMANN
MEDIZINTECHNIK



ARTHROSCOPY



ELECTRO-SURGERY



LAPAROSCOPY



ENDOSCOPIC UNITS



GENERAL SURGERY



PLASTIC SURGERY



TITANIUM IMPLANT SYSTEMS



UROLOGY / HYSTEROSCOPY



Für weitere Informationen besuchen Sie bitte unsere Website oder kontaktieren Sie uns persönlich

For more Information please see our website or contact us directly

www.hermann-medizintechnik.de

Order Number Index

<i>art.-no.</i>	<i>page</i>	<i>art.-no.</i>	<i>page</i>	<i>art.-no.</i>	<i>page</i>	<i>art.-no.</i>	<i>page</i>	<i>art.-no.</i>	<i>page</i>
H00-020-000	8	H00-333-720	16	H00-533-740	18	H00-545-741	18	H18-533-123HM	33
H00-133-590	10	H00-333-741	18	H00-533-741	18	H00-545-742	22	H18-533-635	33
H00-133-590HM	12	H00-333-770	24	H00-533-742	22	H00-545-760	18	H18-545-110HM	33
H00-133-690	20	H00-333-772	24	H00-533-751	26	H00-545-770	24	H18-545-111HM	33
H00-133-765	30	H00-333-820	16	H00-533-760	18	H00-545-772	24	H18-545-114HM	33
H00-133-770	24	H00-333-990	18	H00-533-761	18	H00-545-801	24	H18-545-124HM	33
H00-133-773	24	H00-533-110HM	32	H00-533-770	24	H00-545-803	24	H188-70110	59
H00-133-800	24	H00-533-111HM	32	H00-533-771	24	H00-545-821	16	H188-75220	59
H00-133-804	24	H00-533-113HM	32	H00-533-772	24	H00-545-822	16	H188-79527	59
H00-133-900	28	H00-533-114HM	32	H00-533-780	16	H00-545-901	28	H188-79540	59
H00-133-910	28	H00-533-120HM	32	H00-533-801	24	H00-545-920	28	H188-98010	59
H00-133-921	28	H00-533-121HM	32	H00-533-803	24	H00-545-950	30	H188-99002	59
H00-133-941	28	H00-533-123HM	32	H00-533-810	30	H00-545-954	28	H188-99003	59
H00-133-951	30	H00-533-501	10	H00-533-821	16	H00-545-990	18	H188-99010	59
H00-133-955	28	H00-533-510	10	H00-533-822	16	H112-94200	44	H188-99020	59
H00-133-961	28	H00-533-510HM	12	H00-533-830	18	H16-533-350HM	34	H19-000-000	9
H00-133-970	26	H00-533-515	10	H00-533-901	28	H16-533-351HM	34	H19-133-985	33
H00-133-985	32	H00-533-515HM	12	H00-533-920	28	H16-533-352HM	34	H19-533-110HM	33
H00-145-690	20	H00-533-521	30	H00-533-940	28	H16-533-353HM	34	H19-533-111HM	33
H00-145-770	24	H00-533-530	10	H00-533-950	30	H16-533-354HM	34	H19-533-113HM	33
H00-145-773	24	H00-533-530HM	12	H00-533-954	28	H16-533-355HM	34	H19-533-114HM	33
H00-145-800	24	H00-533-533	10	H00-533-960	28	H16-533-356HM	34	H19-533-120HM	33
H00-145-804	24	H00-533-535	10	H00-533-990	18	H16-533-357HM	34	H19-533-121HM	33
H00-145-900	28	H00-533-535HM	12	H00-545-110HM	32	H16-545-350HM	34	H19-533-123HM	33
H00-145-951	30	H00-533-539	10	H00-545-111HM	32	H16-545-351HM	34	H19-533-635	33
H00-145-955	28	H00-533-550	10	H00-545-114HM	32	H16-545-352HM	34	H19-545-110HM	33
H00-145-970	26	H00-533-581	16	H00-545-124HM	32	H16-545-353HM	34	H19-545-111HM	33
H00-300-000	58	H00-533-610	14	H00-545-501	10	H16-545-354HM	34	H19-545-114HM	33
H00-325-113HM	32	H00-533-630	14	H00-545-530	10	H16-545-355HM	34	H19-545-124HM	33
H00-325-535	10	H00-533-635	32	H00-545-535	10	H16-545-356HM	34	H30-000-000	9
H00-325-610	14	H00-533-641	26	H00-545-535HM	12	H16-545-357HM	34	H30-133-000	8
H00-325-641	26	H00-533-645	26	H00-545-539	10	H17-533-033HM	34	H30-133-590	11
H00-325-680	14	H00-533-661	26	H00-545-610	14	H17-533-034HM	34	H30-133-590HM	13
H00-325-683	22	H00-533-670	20	H00-545-630	14	H17-533-133HM	34	H30-133-882E	35
H00-325-714	20	H00-533-672	20	H00-545-641	26	H17-533-134HM	34	H30-133-882P	35
H00-325-716	20	H00-533-680	14	H00-545-661	26	H17-533-233HM	34	H30-133-883E	35
H00-325-718	20	H00-533-682	22	H00-545-670	20	H17-533-234HM	34	H30-133-883P	35
H00-325-720	16	H00-533-683	22	H00-545-672	20	H17-533-333HM	34	H30-133-884E	35
H00-325-741	18	H00-533-700	14	H00-545-680	14	H17-533-334HM	34	H30-133-884P	35
H00-325-770	24	H00-533-708	20	H00-545-682	22	H17-545-033HM	34	H30-133-970	27
H00-325-772	24	H00-533-710	20	H00-545-683	22	H17-545-034HM	34	H30-145-000	8
H00-325-820	16	H00-533-712	22	H00-545-708	20	H17-545-133HM	34	H30-145-970	27
H00-325-990	18	H00-533-713	22	H00-545-710	20	H17-545-134HM	34	H30-325-535	11
H00-333-113HM	32	H00-533-714	20	H00-545-714	20	H17-545-233HM	34	H30-325-641	27
H00-333-535	10	H00-533-716	20	H00-545-716	20	H17-545-234HM	34	H30-333-535	11
H00-333-610	14	H00-533-717	20	H00-545-717	20	H17-545-333HM	34	H30-333-641	27
H00-333-641	26	H00-533-718	20	H00-545-718	20	H17-545-334HM	34	H30-533-000	8
H00-333-680	14	H00-533-719	22	H00-545-720	16	H18-133-985	33	H30-533-501	11
H00-333-683	22	H00-533-720	16	H00-545-721	16	H18-533-110HM	33	H30-533-510	11
H00-333-710	20	H00-533-721	16	H00-545-722	24	H18-533-111HM	33	H30-533-510HM	13
H00-333-714	20	H00-533-722	24	H00-545-725	24	H18-533-113HM	33	H30-533-515	11
H00-333-716	20	H00-533-725	24	H00-545-731	16	H18-533-114HM	33	H30-533-515HM	13
H00-333-717	20	H00-533-731	16	H00-545-732	16	H18-533-120HM	33	H30-533-521	31
H00-333-718	20	H00-533-732	16	H00-545-740	18	H18-533-121HM	33	H30-533-530	11

<i>art.-no.</i>	<i>page</i>	<i>art.-no.</i>	<i>page</i>	<i>art.-no.</i>	<i>page</i>	<i>art.-no.</i>	<i>page</i>	<i>art.-no.</i>	<i>page</i>
H30-533-530HM	13	H35-133-690	21	H35-533-120HM	33	H35-545-610	15	H38-145-900	29
H30-533-533	11	H35-133-765	31	H35-533-121HM	33	H35-545-630	15	H38-145-951	31
H30-533-535	11	H35-133-770	25	H35-533-123HM	33	H35-545-670	21	H38-145-955	29
H30-533-535HM	13	H35-133-773	25	H35-533-581	17	H35-545-672	21	H38-325-113HM	33
H30-533-539	11	H35-133-800	25	H35-533-610	15	H35-545-680	15	H38-325-610	15
H30-533-550	11	H35-133-804	25	H35-533-630	15	H35-545-682	23	H38-325-680	15
H30-533-641	27	H35-133-900	29	H35-533-635	33	H35-545-683	23	H38-325-683	23
H30-533-645	27	H35-133-910	29	H35-533-670	21	H35-545-708	21	H38-325-714	21
H30-533-661	27	H35-133-921	29	H35-533-672	21	H35-545-710	21	H38-325-716	21
H30-533-751	27	H35-133-941	29	H35-533-680	15	H35-545-714	21	H38-325-718	21
H30-533-881E	35	H35-133-951	31	H35-533-682	23	H35-545-716	21	H38-325-720	17
H30-533-881P	35	H35-133-955	29	H35-533-683	23	H35-545-717	21	H38-325-741	19
H30-545-000	8	H35-133-961	29	H35-533-700	15	H35-545-718	21	H38-325-770	25
H30-545-501	11	H35-133-985	33	H35-533-708	21	H35-545-720	17	H38-325-772	25
H30-545-530	11	H35-145-690	21	H35-533-710	21	H35-545-721	17	H38-325-820	17
H30-545-535	11	H35-145-770	25	H35-533-712	23	H35-545-722	25	H38-325-990	19
H30-545-535HM	13	H35-145-773	25	H35-533-713	23	H35-545-725	25	H38-333-113HM	33
H30-545-539	11	H35-145-800	25	H35-533-714	21	H35-545-731	17	H38-333-610	15
H30-545-641	27	H35-145-804	25	H35-533-716	21	H35-545-732	17	H38-333-680	15
H30-545-661	27	H35-145-900	29	H35-533-717	21	H35-545-740	19	H38-333-683	23
H31-000-000	9	H35-145-951	31	H35-533-718	21	H35-545-741	19	H38-333-710	21
H31-133-765	31	H35-145-955	29	H35-533-719	23	H35-545-742	23	H38-333-714	21
H31-133-900	29	H35-325-113HM	33	H35-533-720	17	H35-545-760	19	H38-333-716	21
H31-133-910	29	H35-325-610	15	H35-533-721	17	H35-545-770	25	H38-333-717	21
H31-133-921	29	H35-325-680	15	H35-533-722	25	H35-545-772	25	H38-333-718	21
H31-133-941	29	H35-325-683	23	H35-533-725	25	H35-545-801	25	H38-333-720	17
H31-133-951	31	H35-325-714	21	H35-533-731	17	H35-545-803	25	H38-333-741	19
H31-133-955	29	H35-325-716	21	H35-533-732	17	H35-545-821	17	H38-333-770	25
H31-133-961	29	H35-325-718	21	H35-533-740	19	H35-545-822	17	H38-333-772	25
H31-133-970	27	H35-325-720	17	H35-533-741	19	H35-545-901	29	H38-333-820	17
H31-145-900	29	H35-325-741	19	H35-533-742	23	H35-545-920	29	H38-333-990	19
H31-145-951	31	H35-325-770	25	H35-533-760	19	H35-545-950	31	H38-533-110HM	33
H31-145-955	29	H35-325-772	25	H35-533-761	19	H35-545-954	29	H38-533-111HM	33
H31-145-970	27	H35-325-820	17	H35-533-770	25	H35-545-990	19	H38-533-113HM	33
H31-325-641	27	H35-325-990	19	H35-533-771	25	H38-000-000	9	H38-533-114HM	33
H31-333-641	27	H35-333-113HM	33	H35-533-772	25	H38-133-690	21	H38-533-120HM	33
H31-533-641	27	H35-333-610	15	H35-533-780	17	H38-133-765	31	H38-533-121HM	33
H31-533-645	27	H35-333-680	15	H35-533-801	25	H38-133-770	25	H38-533-123HM	33
H31-533-661	27	H35-333-683	23	H35-533-803	25	H38-133-773	25	H38-533-581	17
H31-533-751	27	H35-333-710	21	H35-533-810	31	H38-133-800	25	H38-533-610	15
H31-533-810	31	H35-333-714	21	H35-533-821	17	H38-133-804	25	H38-533-630	15
H31-533-901	29	H35-333-716	21	H35-533-822	17	H38-133-900	29	H38-533-635	33
H31-533-920	29	H35-333-717	21	H35-533-830	19	H38-133-910	29	H38-533-670	21
H31-533-940	29	H35-333-718	21	H35-533-901	29	H38-133-921	29	H38-533-672	21
H31-533-950	31	H35-333-720	17	H35-533-920	29	H38-133-941	29	H38-533-680	15
H31-533-954	29	H35-333-741	19	H35-533-940	29	H38-133-951	31	H38-533-682	23
H31-533-960	29	H35-333-770	25	H35-533-950	31	H38-133-955	29	H38-533-683	23
H31-545-641	27	H35-333-772	25	H35-533-954	29	H38-133-961	29	H38-533-700	15
H31-545-661	27	H35-333-820	17	H35-533-960	29	H38-133-985	33	H38-533-708	21
H31-545-901	29	H35-333-990	19	H35-533-990	19	H38-145-690	21	H38-533-710	21
H31-545-920	29	H35-533-110HM	33	H35-545-110HM	33	H38-145-770	25	H38-533-712	23
H31-545-950	31	H35-533-111HM	33	H35-545-111HM	33	H38-145-773	25	H38-533-713	23
H31-545-954	29	H35-533-113HM	33	H35-545-114HM	33	H38-145-800	25	H38-533-714	21
H35-000-000	9	H35-533-114HM	33	H35-545-124HM	33	H38-145-804	25	H38-533-716	21

Order Number Index

<i>art.-no.</i>	<i>page</i>	<i>art.-no.</i>	<i>page</i>	<i>art.-no.</i>	<i>page</i>	<i>art.-no.</i>	<i>page</i>	<i>art.-no.</i>	<i>page</i>
H38-533-717	21	H38-545-740	19	H40-333-717	21	H40-533-761	19	H41-133-773	25
H38-533-718	21	H38-545-741	19	H40-333-718	21	H40-533-770	25	H41-133-800	25
H38-533-719	23	H38-545-742	23	H40-333-720	17	H40-533-771	25	H41-133-804	25
H38-533-720	17	H38-545-760	19	H40-333-741	19	H40-533-772	25	H41-133-970	27
H38-533-721	17	H38-545-770	25	H40-333-770	25	H40-533-780	17	H41-145-690	21
H38-533-722	25	H38-545-772	25	H40-333-772	25	H40-533-801	25	H41-145-770	25
H38-533-725	25	H38-545-801	25	H40-333-820	17	H40-533-803	25	H41-145-773	25
H38-533-731	17	H38-545-803	25	H40-333-990	19	H40-533-821	17	H41-145-800	25
H38-533-732	17	H38-545-821	17	H40-533-000	8	H40-533-822	17	H41-145-804	25
H38-533-740	19	H38-545-822	17	H40-533-501	11	H40-533-830	19	H41-145-970	27
H38-533-741	19	H38-545-901	29	H40-533-510	11	H40-533-990	19	H41-325-535	11
H38-533-742	23	H38-545-920	29	H40-533-510HM	13	H40-545-000	8	H41-325-610	15
H38-533-760	19	H38-545-950	31	H40-533-515	11	H40-545-501	11	H41-325-641	27
H38-533-761	19	H38-545-954	29	H40-533-515HM	13	H40-545-530	11	H41-325-680	15
H38-533-770	25	H38-545-990	19	H40-533-521	31	H40-545-535	11	H41-325-683	23
H38-533-771	25	H40-000-000	9	H40-533-530	11	H40-545-535HM	13	H41-325-714	21
H38-533-772	25	H40-133-000	8	H40-533-530HM	13	H40-545-539	11	H41-325-716	21
H38-533-780	17	H40-133-590	11	H40-533-533	11	H40-545-610	15	H41-325-718	21
H38-533-801	25	H40-133-590HM	13	H40-533-535	11	H40-545-630	15	H41-325-720	17
H38-533-803	25	H40-133-690	21	H40-533-535HM	13	H40-545-641	27	H41-325-741	19
H38-533-810	31	H40-133-770	25	H40-533-539	11	H40-545-661	27	H41-325-770	25
H38-533-821	17	H40-133-773	25	H40-533-550	11	H40-545-670	21	H41-325-772	25
H38-533-822	17	H40-133-800	25	H40-533-581	17	H40-545-672	21	H41-325-820	17
H38-533-830	19	H40-133-804	25	H40-533-610	15	H40-545-680	15	H41-325-990	19
H38-533-901	29	H40-133-970	27	H40-533-630	15	H40-545-682	23	H41-333-535	11
H38-533-920	29	H40-145-000	8	H40-533-641	27	H40-545-683	23	H41-333-610	15
H38-533-940	29	H40-145-690	21	H40-533-645	27	H40-545-708	21	H41-333-641	27
H38-533-950	31	H40-145-770	25	H40-533-661	27	H40-545-710	21	H41-333-680	15
H38-533-954	29	H40-145-773	25	H40-533-670	21	H40-545-714	21	H41-333-683	23
H38-533-960	29	H40-145-800	25	H40-533-672	21	H40-545-716	21	H41-333-710	21
H38-533-990	19	H40-145-804	25	H40-533-680	15	H40-545-717	21	H41-333-714	21
H38-545-110HM	33	H40-145-970	27	H40-533-682	23	H40-545-718	21	H41-333-716	21
H38-545-111HM	33	H40-325-535	11	H40-533-683	23	H40-545-720	17	H41-333-717	21
H38-545-114HM	33	H40-325-610	15	H40-533-700	15	H40-545-721	17	H41-333-718	21
H38-545-124HM	33	H40-325-641	27	H40-533-708	21	H40-545-722	25	H41-333-720	17
H38-545-610	15	H40-325-680	15	H40-533-710	21	H40-545-725	25	H41-333-741	19
H38-545-630	15	H40-325-683	23	H40-533-712	23	H40-545-731	17	H41-333-770	25
H38-545-670	21	H40-325-714	21	H40-533-713	23	H40-545-732	17	H41-333-772	25
H38-545-672	21	H40-325-716	21	H40-533-714	21	H40-545-740	19	H41-333-820	17
H38-545-680	15	H40-325-718	21	H40-533-716	21	H40-545-741	19	H41-333-990	19
H38-545-682	23	H40-325-720	17	H40-533-717	21	H40-545-742	23	H41-533-501	11
H38-545-683	23	H40-325-741	19	H40-533-718	21	H40-545-760	19	H41-533-510	11
H38-545-708	21	H40-325-770	25	H40-533-719	23	H40-545-770	25	H41-533-510HM	13
H38-545-710	21	H40-325-772	25	H40-533-720	17	H40-545-772	25	H41-533-515	11
H38-545-714	21	H40-325-820	17	H40-533-721	17	H40-545-801	25	H41-533-515HM	13
H38-545-716	21	H40-325-990	19	H40-533-722	25	H40-545-803	25	H41-533-521	31
H38-545-717	21	H40-333-535	11	H40-533-725	25	H40-545-821	17	H41-533-530	11
H38-545-718	21	H40-333-610	15	H40-533-731	17	H40-545-822	17	H41-533-530HM	13
H38-545-720	17	H40-333-641	27	H40-533-732	17	H40-545-990	19	H41-533-533	11
H38-545-721	17	H40-333-680	15	H40-533-740	19	H41-000-000	9	H41-533-535	11
H38-545-722	25	H40-333-683	23	H40-533-741	19	H41-133-590	11	H41-533-535HM	13
H38-545-725	25	H40-333-710	21	H40-533-742	23	H41-133-590HM	13	H41-533-539	11
H38-545-731	17	H40-333-714	21	H40-533-751	27	H41-133-690	21	H41-533-550	11
H38-545-732	17	H40-333-716	21	H40-533-760	19	H41-133-770	25	H41-533-581	17

<i>art.-no.</i>	<i>page</i>	<i>art.-no.</i>	<i>page</i>	<i>art.-no.</i>	<i>page</i>	<i>art.-no.</i>	<i>page</i>	<i>art.-no.</i>	<i>page</i>
H41-533-610	15	H41-545-683	23	H43-325-714	21	H43-533-720	17	H43-545-740	19
H41-533-630	15	H41-545-708	21	H43-325-716	21	H43-533-721	17	H43-545-741	19
H41-533-641	27	H41-545-710	21	H43-325-718	21	H43-533-722	25	H43-545-742	23
H41-533-645	27	H41-545-714	21	H43-325-720	17	H43-533-725	25	H43-545-760	19
H41-533-661	27	H41-545-716	21	H43-325-741	19	H43-533-731	17	H43-545-770	25
H41-533-670	21	H41-545-717	21	H43-325-770	25	H43-533-732	17	H43-545-772	25
H41-533-672	21	H41-545-718	21	H43-325-772	25	H43-533-740	19	H43-545-801	25
H41-533-680	15	H41-545-720	17	H43-325-820	17	H43-533-741	19	H43-545-803	25
H41-533-682	23	H41-545-721	17	H43-325-990	19	H43-533-742	23	H43-545-821	17
H41-533-683	23	H41-545-722	25	H43-333-113HM	33	H43-533-751	27	H43-545-822	17
H41-533-700	15	H41-545-725	25	H43-333-610	15	H43-533-760	19	H43-545-901	29
H41-533-708	21	H41-545-731	17	H43-333-641	27	H43-533-761	19	H43-545-920	29
H41-533-710	21	H41-545-732	17	H43-333-680	15	H43-533-770	25	H43-545-950	31
H41-533-712	23	H41-545-740	19	H43-333-683	23	H43-533-771	25	H43-545-954	29
H41-533-713	23	H41-545-741	19	H43-333-710	21	H43-533-772	25	H43-545-990	19
H41-533-714	21	H41-545-742	23	H43-333-714	21	H43-533-780	17	H70-300-005	49
H41-533-716	21	H41-545-760	19	H43-333-716	21	H43-533-801	25	H70-333-110	49
H41-533-717	21	H41-545-770	25	H43-333-717	21	H43-533-803	25	H70-333-111	49
H41-533-718	21	H41-545-772	25	H43-333-718	21	H43-533-810	31	H70-333-112	49
H41-533-719	23	H41-545-801	25	H43-333-720	17	H43-533-821	17	H70-333-113	49
H41-533-720	17	H41-545-803	25	H43-333-741	19	H43-533-822	17	H70-333-114	49
H41-533-721	17	H41-545-821	17	H43-333-770	25	H43-533-830	19	H70-500-005	49
H41-533-722	25	H41-545-822	17	H43-333-772	25	H43-533-901	29	H70-533-000	49
H41-533-725	25	H41-545-990	19	H43-333-820	17	H43-533-920	29	H70-533-100	48
H41-533-731	17	H43-000-000	9	H43-333-990	19	H43-533-940	29	H70-533-101	48
H41-533-732	17	H43-133-690	21	H43-533-110HM	33	H43-533-950	31	H70-533-102	48
H41-533-740	19	H43-133-765	31	H43-533-111HM	33	H43-533-954	29	H70-533-103	48
H41-533-741	19	H43-133-770	25	H43-533-113HM	33	H43-533-960	29	H70-533-110	49
H41-533-742	23	H43-133-773	25	H43-533-114HM	33	H43-533-990	19	H70-533-111	49
H41-533-751	27	H43-133-800	25	H43-533-120HM	33	H43-545-110HM	33	H70-533-112	49
H41-533-760	19	H43-133-804	25	H43-533-121HM	33	H43-545-111HM	33	H70-533-113	49
H41-533-761	19	H43-133-900	29	H43-533-123HM	33	H43-545-114HM	33	H70-533-114	49
H41-533-770	25	H43-133-910	29	H43-533-581	17	H43-545-124HM	33	H70-533-120	49
H41-533-772	25	H43-133-921	29	H43-533-610	15	H43-545-610	15	H70-533-121	49
H41-533-780	17	H43-133-941	29	H43-533-630	15	H43-545-630	15	H70-533-122	49
H41-533-801	25	H43-133-951	31	H43-533-635	33	H43-545-641	27	H70-533-123	49
H41-533-803	25	H43-133-955	29	H43-533-641	27	H43-545-661	27	H70-533-124	49
H41-533-821	17	H43-133-961	29	H43-533-645	27	H43-545-670	21	H70-533-130	49
H41-533-822	17	H43-133-970	27	H43-533-661	27	H43-545-672	21	H70-533-131	49
H41-533-830	19	H43-133-985	33	H43-533-670	21	H43-545-680	15	H70-533-132	49
H41-533-990	19	H43-145-690	21	H43-533-672	21	H43-545-682	23	H70-533-133	49
H41-545-501	11	H43-145-770	25	H43-533-680	15	H43-545-683	23	H70-533-134	49
H41-545-530	11	H43-145-773	25	H43-533-682	23	H43-545-708	21	H70-533-141	48
H41-545-535	11	H43-145-800	25	H43-533-683	23	H43-545-710	21	H70-533-142	48
H41-545-535HM	13	H43-145-804	25	H43-533-700	15	H43-545-714	21	H70-533-143	48
H41-545-539	11	H43-145-900	29	H43-533-708	21	H43-545-716	21	H70-545-110	49
H41-545-610	15	H43-145-951	31	H43-533-710	21	H43-545-717	21	H70-545-111	49
H41-545-630	15	H43-145-955	29	H43-533-712	23	H43-545-718	21	H70-545-112	49
H41-545-641	27	H43-145-970	27	H43-533-713	23	H43-545-720	17	H70-545-113	49
H41-545-661	27	H43-325-113HM	33	H43-533-714	21	H43-545-721	17	H70-545-114	49
H41-545-670	21	H43-325-610	15	H43-533-716	21	H43-545-722	25	H8-1810-74	57
H41-545-672	21	H43-325-641	27	H43-533-717	21	H43-545-725	25	H8-1810-80	56
H41-545-680	15	H43-325-680	15	H43-533-718	21	H43-545-731	17	H8-1810-81	56
H41-545-682	23	H43-325-683	23	H43-533-719	23	H43-545-732	17	H8-1810-82	56

Order Number Index

<i>art.-no.</i>	<i>page</i>	<i>art.-no.</i>	<i>page</i>	<i>art.-no.</i>	<i>page</i>	<i>art.-no.</i>	<i>page</i>	<i>art.-no.</i>	<i>page</i>
H8-1810-83	56	H8-2210-981	57	H8-2622-83	56	H80-050-08	40	H80-1012-12	41
H8-1810-84	57	H8-2215-73	57	H8-2622-84	57	H80-050-A	37	H80-1012-14	41
H8-1810-86	57	H8-2215-74	57	H8-3010-82	56	H80-055-01	40	H80-1013-05	41
H8-1810-90	57	H8-2215-80	56	H8-3010-83	56	H80-055-01S	40	H80-1013-14	41
H8-1810-91	57	H8-2215-81	56	H8-3015-82	56	H80-055-02	40	H80-1015-00	41
H8-1810-92	57	H8-2215-82	56	H8-3015-83	56	H80-055-02S	40	H80-1015-11	51
H8-1810-981	57	H8-2215-83	56	H8-3018-82	56	H80-055-05	40	H80-1020-00	41
H8-1815-74	57	H8-2215-84	57	H8-3018-83	56	H80-055-05S	40	H80-1020-11	51
H8-1815-80	56	H8-2215-86	57	H8-3022-82	56	H80-055-06	40	H80-105-01	40
H8-1815-81	56	H8-2215-88	57	H8-3022-83	56	H80-055-07	40	H80-105-02	40
H8-1815-82	56	H8-2215-90	57	H8-3410-80	56	H80-055-08	40	H80-106-00	36
H8-1815-83	56	H8-2215-91	57	H8-3410-81	56	H80-055-08S	40	H80-110-01	40
H8-1815-84	57	H8-2215-92	57	H8-3415-80	56	H80-0556-00	36	H80-110-01S	40
H8-1815-86	57	H8-2215-93	57	H8-3415-81	56	H80-0556-00B	37	H80-110-02	40
H8-1815-90	57	H8-2215-94	57	H8-3418-80	56	H80-0556-00C	37	H80-110-02S	40
H8-1815-91	57	H8-2215-981	57	H8-3418-81	56	H80-0556-00D	37	H80-110-05	40
H8-1815-92	57	H8-2218-73	57	H8-3422-80	56	H80-0556-00S	36	H80-110-05S	40
H8-1815-981	57	H8-2218-74	57	H8-3422-81	56	H80-055-A	37	H80-110-06	40
H8-1818-74	57	H8-2218-80	56	H80-000-10	45	H80-055-AS	37	H80-110-07	40
H8-1818-80	56	H8-2218-81	56	H80-000-12	45	H80-055-B	37	H80-110-08	40
H8-1818-81	56	H8-2218-82	56	H80-000-18	45	H80-055-C	37	H80-110-08S	40
H8-1818-82	56	H8-2218-83	56	H80-000-19		H80-055-D	37	H80-110-A	37
H8-1818-83	56	H8-2218-84	57	H80-000-20	45	H80-055-K	41	H80-110-AS	37
H8-1818-84	57	H8-2218-86	57	H80-000-21	45	H80-056-00	36	H80-110-B	37
H8-1818-86	57	H8-2218-88	57	H80-000-22	45	H80-070-01	40	H80-110-C	37
H8-1818-90	57	H8-2218-90	57	H80-000-23	45	H80-070-02	40	H80-110-D	37
H8-1818-91	57	H8-2218-91	57	H80-000-24	45	H80-070-A	37	H80-110-K	41
H8-1818-92	57	H8-2218-92	57	H80-000-25	45	H80-076-00	36	H80-116-00	36
H8-1818-981	57	H8-2218-93	57	H80-000-26	45	H80-080-01	40	H80-116-00B	37
H8-1822-74	57	H8-2218-94	57	H80-000-27	45	H80-080-02	40	H80-116-00C	37
H8-1822-80	56	H8-2218-981	57	H80-000-28	45	H80-080-05	40	H80-116-00D	37
H8-1822-81	56	H8-2222-73	57	H80-000-30	47	H80-080-06	40	H80-116-00S	36
H8-1822-82	56	H8-2222-74	57	H80-000-31	47	H80-080-08	40	H80-120-01	40
H8-1822-83	56	H8-2222-80	56	H80-000-32	47	H80-080-A	37	H80-120-01S	40
H8-1822-84	57	H8-2222-81	56	H80-000-33	47	H80-086-00	36	H80-120-02	40
H8-1822-86	57	H8-2222-82	56	H80-000-34	47	H80-100-01	40	H80-120-02S	40
H8-1822-90	57	H8-2222-83	56	H80-000-35	47	H801-00010	54	H80-120-05	40
H8-1822-91	57	H8-2222-84	57	H80-000-36	47	H801-00013	54	H80-120-05S	40
H8-1822-92	57	H8-2222-86	57	H80-000-37	47	H801-00017	54	H80-120-06	40
H8-1822-981	57	H8-2222-88	57	H80-000-38	47	H801-00018	54	H80-120-07	40
H8-2210-73	57	H8-2222-90	57	H80-000-39	47	H801-00019	54	H80-120-08	40
H8-2210-74	57	H8-2222-91	57	H80-000-51	46	H80-100-02	40	H80-120-08S	40
H8-2210-80	56	H8-2222-92	57	H80-000-52	46	H801-00020	54	H80-125-A	37
H8-2210-81	56	H8-2222-93	57	H80-035-01	40	H801-00021	54	H80-125-AS	37
H8-2210-82	56	H8-2222-94	57	H80-035-02	40	H801-00022	54	H80-125-B	37
H8-2210-83	56	H8-2222-981	57	H80-035-07	40	H80-100-05	40	H80-125-C	37
H8-2210-84	57	H8-2610-82	56	H80-035-A	37	H80-100-06	40	H80-125-D	37
H8-2210-86	57	H8-2610-83	56	H80-035-K	41	H80-100-07	40	H80-125-K	41
H8-2210-88	57	H8-2615-82	56	H80-036-00	36	H80-100-08	40	H80-126-00	36
H8-2210-90	57	H8-2615-83	56	H80-050-01	40	H801-00260	54	H80-126-00B	37
H8-2210-91	57	H8-2615-84	57	H80-050-02	40	H80-100-A	37	H80-126-00C	37
H8-2210-92	57	H8-2618-82	56	H80-050-05	40	H80-100-K	41	H80-126-00D	37
H8-2210-93	57	H8-2618-83	56	H80-050-06	40	H80-1012-00	41	H80-126-00S	36
H8-2210-94	57	H8-2622-82	56	H80-050-07	40	H80-1012-05	41	H80-130-01	40

<i>art.-no.</i>	<i>page</i>	<i>art.-no.</i>	<i>page</i>	<i>art.-no.</i>	<i>page</i>	<i>art.-no.</i>	<i>page</i>	<i>art.-no.</i>	<i>page</i>
H80-130-02	40	H80-512-14	41	H80-990-00	58	H81-1130-00D	39	H855-10020	53
H80-130-05	40	H80-513-05	41	H81-0055-00	38	H81-1130-00S	38	H855-10021	53
H80-130-08	40	H80-513-14	41	H81-0055-00B	39	H81-120-00	36	H855-10023	53
H80-130-A	37	H80-515-00	41	H81-0055-00C	39	H81-120-00B	37	H855-10025	53
H80-130-k	41	H80-515-11	51	H81-0055-00D	39	H81-120-00C	37	H855-10027	53
H80-133-02	44	H80-520-00	41	H81-0055-00S	38	H81-120-00D	37	H855-10028	53
H80-133-10	45	H80-520-11	51	H81-0110-00	38	H81-120-00S	36	H855-10029	53
H80-133-11	45	H80-530-12	50	H81-0110-00B	39	H81-130-00	36	H855-10050	52
H80-133-12	45	H80-530-18	50	H81-0110-00C	39	H81-130-A	39	H855-10060	53
H80-133-13	45	H80-533-06	44	H81-0110-00D	39	H81-130-AS	39	H855-10061	53
H80-134-06	44	H80-533-07	44	H81-0110-00S	38	H81-130-B	39	H855-10063	53
H80-134-07	44	H80-533-12	50	H81-0130-00	38	H81-130-C	39	H855-10065	53
H80-136-04	44	H80-533-15	50	H81-0130-00B	39	H81-130-D	39	H855-10067	53
H80-136-05	44	H80-533-17	51	H81-0130-00C	39	H81-150-00	36	H855-10068	53
H80-140-01	58	H80-534-04	44	H81-0130-00D	39	H81-200-00	36	H855-10069	53
H80-145-02	44	H80-534-05	44	H81-0130-00S	38	H824-00010	54	H855-30000	52
H80-150-01	40	H80-540-01	58	H81-030-00	36	H824-00011	54	H855-30001	52
H80-150-02	40	H80-540-12	50	H81-050-00	36	H824-00014	54	H855-30010	53
H80-1520-00	41	H80-545-12	50	H81-050-B	42	H824-00015	54	H855-30011	53
H80-200-01	40	H80-545-17	51	H81-0550-00	36	H824-00018	54	H855-30100	53
H80-200-02	40	H80-545-18	50	H81-0550-00B	37	H824-00019	54	H855-30101	53
H80-205-00	43	H80-600-10	44	H81-0550-00C	37	H824-10001	54	H855-30102	53
H80-207-00	43	H80-600-11	44	H81-0550-00D	37	H83-030-000	55	H855-30103	53
H80-208-00	43	H80-620-23	44	H81-0550-00S	36	H83-030-030	55	H855-30110	53
H80-210-00	43	H80-650-01	51	H81-055-A	39	H83-050-000	55	H856-30200	54
H80-210-20	43	H80-650-02	51	H81-055-AS	39	H83-050-030	55	H856-30600	54
H80-212-00	43	H80-900-03	42	H81-055-B	39	H83-050-045	55	H856-30700	54
H80-212-20	43	H80-900-05	42	H81-055-C	39	H83-053-000	55	H91-180-035	55
H80-213-00	43	H80-900-07	42	H81-055-D	39	H83-053-030	55	H91-180-045	55
H80-214-00	43	H80-900-08	42	H81-070-00	36	H83-053-045	55	H91-230-035	55
H80-215-00	43	H80-900-10	42	H81-100-00	36	H83-100-000	55	H91-230-045	55
H80-215-20	43	H80-900-12	42	H81-1055-00	38	H83-100-030	55	H91-300-035	55
H80-217-00	43	H80-900-13	42	H81-1055-00B	39	H83-100-045	55	H91-300-045	55
H80-217-20	43	H80-900-15	42	H81-1055-00C	39	H83-103-000	55	H94-000-060	51
H80-218-00	43	H80-900-20	42	H81-1055-00D	39	H83-103-030	55	H94-000-061	51
H80-220-00	43	H80-900-55	42	H81-1055-00S	38	H83-103-045	55	H94-000-062	51
H80-223-00	43	H80-901-03	42	H81-110-00	36	H855-00000	52	H98-903-030	49
H80-305-00	41	H80-901-05	42	H81-110-00B	37	H855-00005	52	H98-903-035	49
H80-305-05	41	H80-901-06	42	H81-110-00C	37	H855-00050	52	H98-903-050	49
H80-325-12	50	H80-901-10	42	H81-110-00D	37	H855-00102	53	H98-903-055	49
H80-325-15	50	H80-901-11	42	H81-110-00S	36	H855-00103	53		
H80-333-12	50	H80-901-12	42	H81-110-A	39	H855-00104	53		
H80-333-15	50	H80-901-15	42	H81-110-AS	39	H855-00105	53		
H80-333-18	50	H80-901-20	42	H81-110-B	39	H855-00106	53		
H80-510-00	41	H80-902-03	42	H81-110-C	39	H855-00400	53		
H80-510-05	41	H80-902-05	42	H81-110-D	39	H855-10000	52		
H80-510-11	51	H80-902-06	42	H81-1110-00	38	H855-10005	52		
H80-510-14	41	H80-902-10	42	H81-1110-00B	39	H855-10010	53		
H80-511-05	41	H80-902-11	42	H81-1110-00C	39	H855-10011	53		
H80-511-11	51	H80-902-13	42	H81-1110-00D	39	H855-10013	53		
H80-511-14	41	H80-902-15	42	H81-1110-00S	38	H855-10015	53		
H80-512-00	41	H80-902-20	42	H81-1130-00	38	H855-10017	53		
H80-512-05	41	H80-903-03	42	H81-1130-00B	39	H855-10018	53		
H80-512-12	41	H80-903-10	42	H81-1130-00C	39	H855-10019	53		

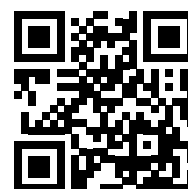

HERMANN
MEDIZINTECHNIK



Hermann Medizintechnik GmbH
Württembergische Straße 26
D-78567 Fridingen/Tuttlingen
GERMANY
Tel. +49-74 63 / 99 67-0
Fax +49-74 63 / 99 67-50
info@hermann-medizintechnik.de
www.hermann-medizintechnik.de
