

# General Surgery

**HERMANN**  
MEDIZINTECHNIK

**Complete range  
of products for  
general surgery**





**HERMANN**  
MEDIZINTECHNIK

**The Company -  
The Quality**



**Das Unternehmen -  
Die Qualität**

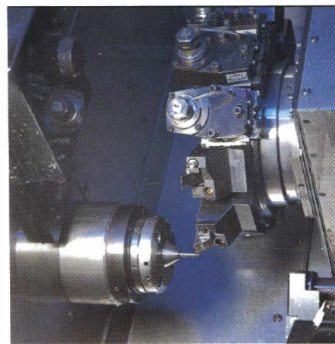

Seit über 40 Jahren sind wir in der Herstellung chirurgischer Instrumente tätig. Aus dem Zusammenwirken des in diesem Zeitraum gewachsenen Know-Hows, den hoch qualifizierten Mitarbeitern, sowie modernster Produktions- Technologie, fertigen wir als ein Chirurgie-Betrieb mittlerer Größe Qualitäts-Instrumente für verschiedene medizinische Fachbereiche. Unterstützt durch die Einführung des Qualitätsmanagement-Systems ist es unser Bestreben, unseren Kunden ein MEHR an Qualität und Sicherheit zu bieten.

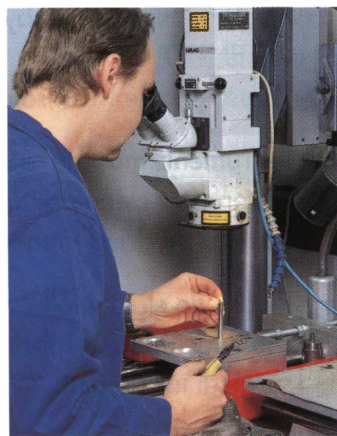

**Für unsere Instrumente  
gewähren wir 1 Jahr Garantie  
in Bezug auf Material- und  
Fabrikationsfehler.**

Desweiteren bieten wir Ihnen an:

- ❖ Instrumente mit und ohne Hartmetall-Einlagen
- ❖ Instrumente und Zubehör für die Arthroskopie, Laparoskopie und Urologie
- ❖ Implantat-Systeme für die Maxillo-Faciale-Chirurgie und Hand/Radius-Chirurgie
- ❖ Mandibular System

**Bitte fordern Sie die  
entsprechenden Kataloge an!**



We have been manufacturing surgical instruments for more than 40 years. From the interaction of the accumulated Know-How, the highly qualified workers and most modern equipment in production. We, as a medium-sized company, manufacture high quality instruments for various medical disciplines. Supported by the introduction of the Quality Management System we strive for offering even MORE Quality and Security.



**For our Instruments we do  
grant a 1-year guarantee  
against defects in material and  
workmanship.**

Furthermore we do offer:

- ❖ Instruments with and without Tungsten Carbide Inserts
- ❖ Instruments and Accessories for Arthroscopy, Laparoscopy and Urology
- ❖ Implantat-Systems for the Maxillo-Facial-Surgery and Hand/Radius-Surgery
- ❖ Mandibular System

**Please do order the  
corresponding catalogues!**



## Richtlinien zur Reinigung von Standard Instrumenten

### Directions for Cleaning for standard Instruments

---

- ⇒ Instrumente **unmittelbar** nach Gebrauch reinigen.
  - ⇒ Zur Vermeidung von Lochfraß/Rost Instrumente nicht in physiologischer Kochsalz-lösung ablegen.
  - ⇒ Um eventuelle Beschädigungen/Verformungen zu vermeiden, Instrumente nicht unsachgemäß "abwerfen".
  - ⇒ Reinigungs- und Desinfektionsmittel auf Raumtemperatur halten; dabei Einwirkzeit und Konzentration der Reinigungsmittel nach Herstellerangaben berücksichtigen!  
ACHTUNG:  
Täglich frische Lösungen verwenden!
  - ⇒ Nach Reinigung/Desinfektion Instrumente immer mit ausreichend klarem, fließendem Wasser nachspülen. Instrumente nach Spülung **sofort** trocknen.
  - ⇒ Hersteller-Angaben von Instrumenten-Pflegemitteln strengstens befolgen.
  - ⇒ **Dampfsterilisation:**
    - ⇒ bis 134° C
    - ⇒ nur Dampf für Sterilisierzwecke (= DIN 58946, Teil 7) verwenden.
    - ⇒ Bedienungsanleitung und Empfehlungen der Sterilisator-Hersteller genauestens beachten!
  - ⇒ **Heißluftsterilisation:**
    - ⇒ 180° - 220° C
    - ⇒ Bedienungsanleitung und Empfehlungen der Sterilisator-Hersteller genauestens beachten!
  - ⇒ Instrumente have to be cleaned **immediately** after use.
  - ⇒ In order to avoid any pitting and rust do not store instruments in physiological Saline Solution.
  - ⇒ Do not throw off instruments improperly in order to avoid any damages/deformations.
  - ⇒ For Cleansing/Desinfection Agents please do consider concentration, temperature and effecting times given by manufacturer!  
ATTENTION:  
Please do use fresh solutions every day!
  - ⇒ Instruments must be rinsed well under running water after cleaning/desinfection. Instruments have to be dried **immediately** after rinsing.
  - ⇒ Please do strictly follow instructions given by Manufacturers of Lubricating Agents for surgical instruments.
  - ⇒ **Sterilization by Steam:**
    - ⇒ up to 134° C
    - ⇒ use steam for sterilization purposes (= DIN 58946, Part 7) only.
    - ⇒ Precisely observe Operating Instructions and Recommendations from Manufacturers of Sterilization Apparatus!
  - ⇒ **Sterilization by Hot Air:**
    - ⇒ 180° - 220° C
    - ⇒ Precisely observe Operating Instructions and Recommendations from Manufacturers of Sterilization Apparatus!
-





**HERMANN**  
MEDIZINTECHNIK

Hermann Medizintechnik GmbH  
Württembergische Straße 26  
D-78567 Fridingen/Tuttlingen  
GERMANY

Tel. +49-74 63 / 99 67-0  
Fax +49-74 63 / 99 67-50

[info@hermann-medizintechnik.de](mailto:info@hermann-medizintechnik.de)  
[www.hermann-medizintechnik.de](http://www.hermann-medizintechnik.de)



**Zeichenerklärung**  
**Explanation of Symbols**  
**Explication des symboles**  
**Explicación de los símbolos**  
**Spiegazione dei simboli**

---

— Gerades Instrument  
Straight Instrument  
Instrument droit  
Instrumento recto  
Strumento retto

⤿ Gebogenes Instrument  
Curved Instrument  
Instrument courbe  
Instrumento curvo  
Strumento curvo

◄ Scharfes Instrument  
Sharp Instrument  
Instrument pointu  
Instrumento agudo  
Strumento acuto

— Stumpfes Instrument  
Blunt Instrument  
Instrument mousse  
Instrumento romo  
Strumento smusso

---





H102-10200  
compl.



000  
200  
compl.



H102-12200  
compl.



H102-13200  
compl.



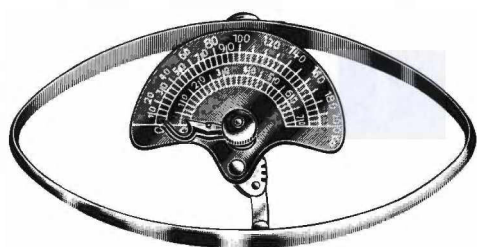

**COLLIN**  
H102-14001 Erwachsene · Adult  
H102-14002 Kinder · Child · enfant  
niños · bambini



**FRANCKE**  
H102-14500



H102-14700



**VARIFOCAL**  
H102-16000

**MAY**  
H102-16200



H102-17200  
Universal





Stirnspiegel-, lampen  
Head Mirrors, Head Lights  
Miroirs, lampes frontales  
Espejos, lámparas frontales  
Riflettori, lampade frontali

102

Stirnlampen  
Head Lights  
Lampes frontales  
Lámparas frontales  
Lampade frontali



H102-18091



ZIEGLER  
H102-18090  
compl.



H102-18092



CLAR  
H102-19000  
compl.  
6 V.



H102-19001



H102-19500  
compl.  
6 V.



H102-19501



H102-19906  
6 Volt



BOWLES  
H102-24000



FORD  
H102-24200



DUPLEX  
H102-24600



FORD-BOWLES  
H102-24400



PINARD  
H102-26015  
15 cm



PINARD  
H102-26218  
18 cm

Perkussionshämmer  
Percussion Hammers  
Marteaux-percuteurs  
Martillos de percusión  
Martelli percussori

02



cm TAYLOR  
17 H102-28817  
20 H102-28820



TRAUBE  
H102-29016



BABINSKY  
H102-29222  
22 cm



TROEMNER  
H102-29424  
24 cm



DEJERINE  
H102-30220



DEJERINE  
H102-30420

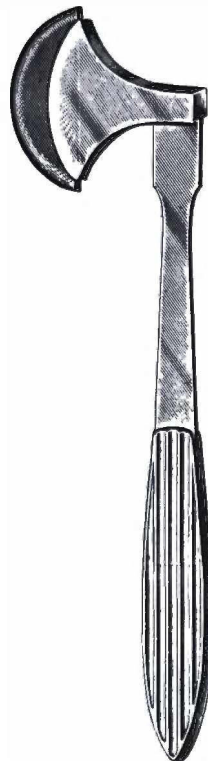

BERLINER  
H102-30617

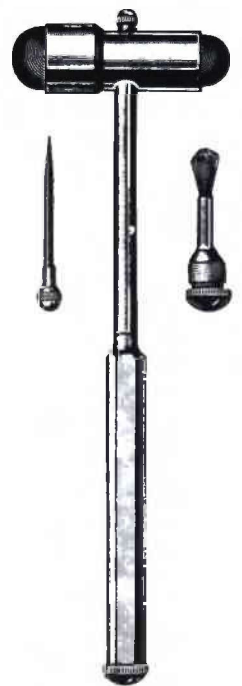

BUCK  
H102-30818

Schädel-Messzirkel  
Cephalometer  
Céphalomètre  
Cefalómetro  
Cefalometro



BERTILLON  
H102-31001

Winkelmesser  
Goniometer  
Goniomètre  
Goniómetro  
Goniometro

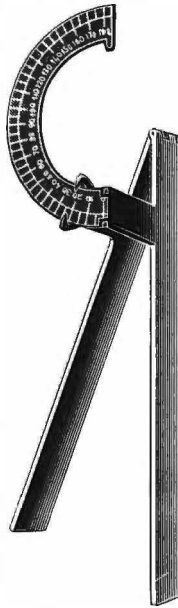

MOELTGEN  
H102-31201

Nadelrad · Pinwheel  
Aesthésiomètre · Sensimetro



WARTENBERG  
H102-32019  
19 cm

Metall-Meßstäbe  
Rulers, metal  
Règles en métal  
Reglas de metal  
Regoli in acciaio



cm	inch.	
10	4	H102-34010
20	8	H102-34020
30	12	H102-34030
50	20	H102-34050



H102-34415  
15 cm

Maßband, Stahl  
Tape measure, steel  
Ruban métrique en acier  
Cinta métrica de acero  
Nastro metrico di acciaio



H102-35015  
1,5 m



Aspiration, Anaesthesie  
Aspiration, Anesthesia  
Aspiration, Anesthésie  
Aspiración, Anestesia  
Aspirazione, Anestesia

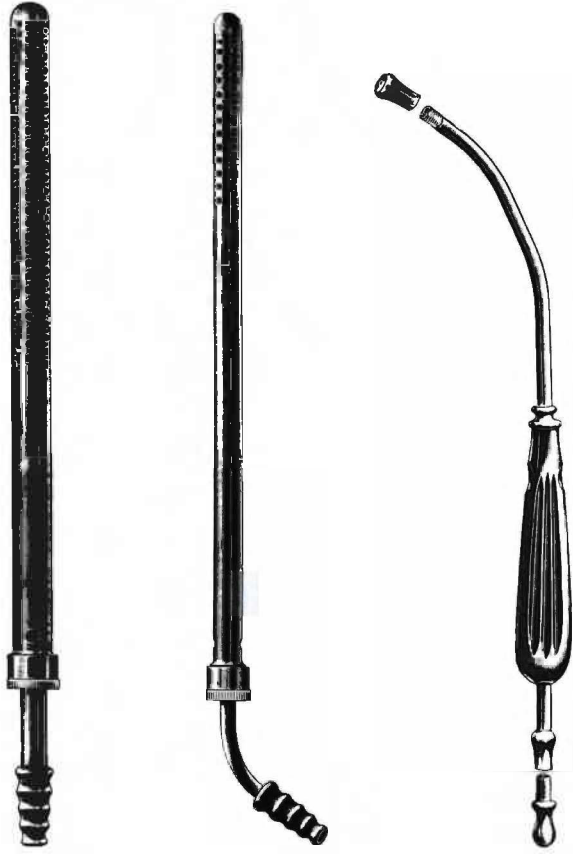

POOLE  
H104-13010  
Ø 10 mm (30 Fr.)

POOLE  
H104-14008  
Ø 8 mm (23 Fr.)

YANKAUER  
H104-15027  
27 cm

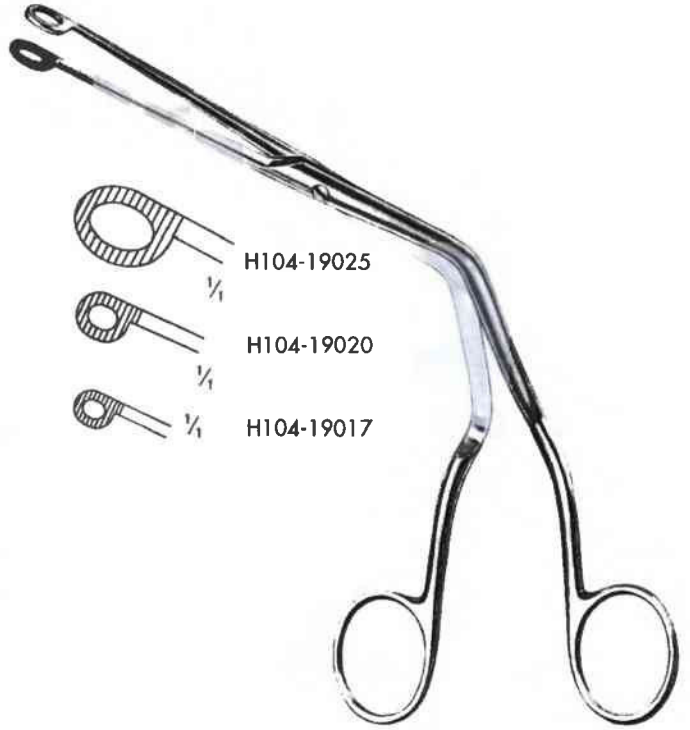

H104-19025  
1/4  
H104-19020  
1/4  
H104-19017  
1/4

cm	MAGILL
17	H104-19017
20	H104-19020
25	H104-19025



	McINTOSH	Fig.	McINTOSH Cold Light	Fig.
Set/3	H104-20300	2-4	H104-20301	2-4
Set/4	H104-20400	1-4	H104-20401	1-4



	FOREGGER	Fig.
	H104-22300	2-4
	H104-22400	1-4

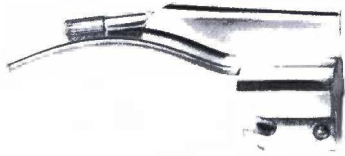

Fig. 0



Fig. 1



Fig. 2

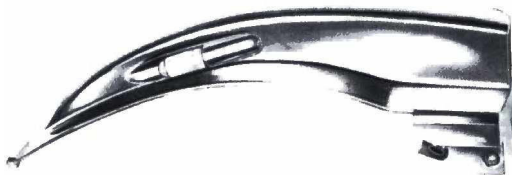

Fig. 3



Fig. 4



Fig. 1



Fig. 2



Fig. 3



Fig. 4

cm	Fig.	normal McINTOSH	Cold Light
5,5	0	H104-21000	H104-21100
7,5	1	H104-21001	H104-21101
9,0	2	H104-21002	H104-21102
11,0	3	H104-21003	H104-21103
13,5	4	H104-21004	H104-21104

cm	Fig.	FOREGGER
7,0	1	H104-22001
9,0	2	H104-22002
11,0	3	H104-22003
13,5	4	H104-22004

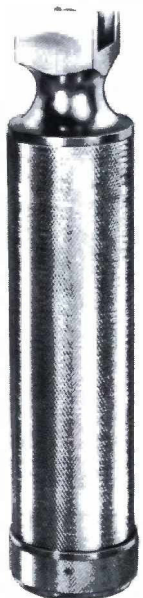

Ø mm

28	H104-23428
37	H104-23437



H104-23901  
f./p. Fig. 1



H104-23902  
f./p. Fig. 2-4



Cold Light  
H104-23801



H104-24000

Skalpelligriffe  
Scalpel Handles  
Manches de bistouris  
Mangos de bisturías  
Manici per bisturi

06



H106-10300  
Fig. 3



H106-10301  
Fig. 3 grad.



H106-10302  
Fig. 3 L

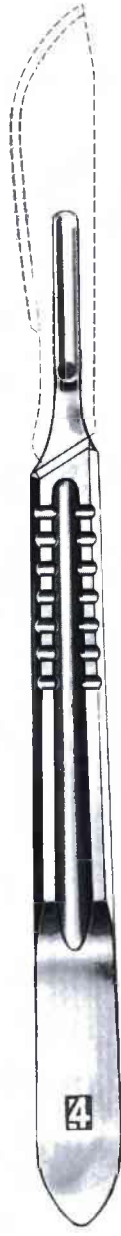

H106-10400  
Fig. 4

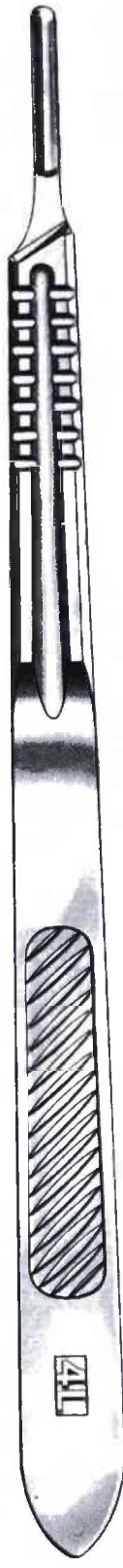

H106-10402  
Fig. 4 L



H106-10700  
Fig. 7



H106-10701  
Fig. 7 K



H106-10800  
Fig. 8

Skalpelli, steril  
Scalpel Blades, Sterile  
Lames de bistouris, stériles  
Hojas de bisturíes estériles  
Lame da bisturi, sterili

in Packungen à 100 Stück  
in packages of 100 ea  
en boîtes de 100 pièces  
en cajas de 100 c/u  
in scatole di 100 pezzi

10

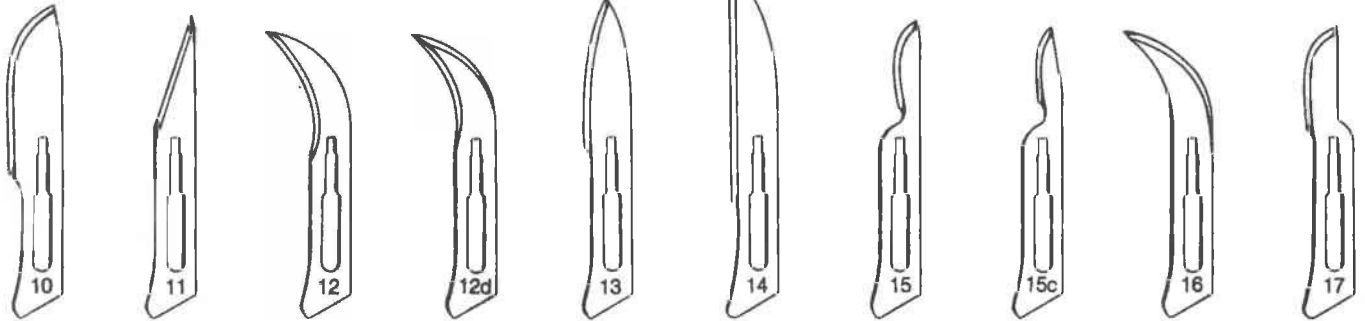

H106-11000 H106-11100 H106-11200 H106-11202 H106-11300 H106-11400 H106-11500 H106-11501 H106-11600 H106-11700

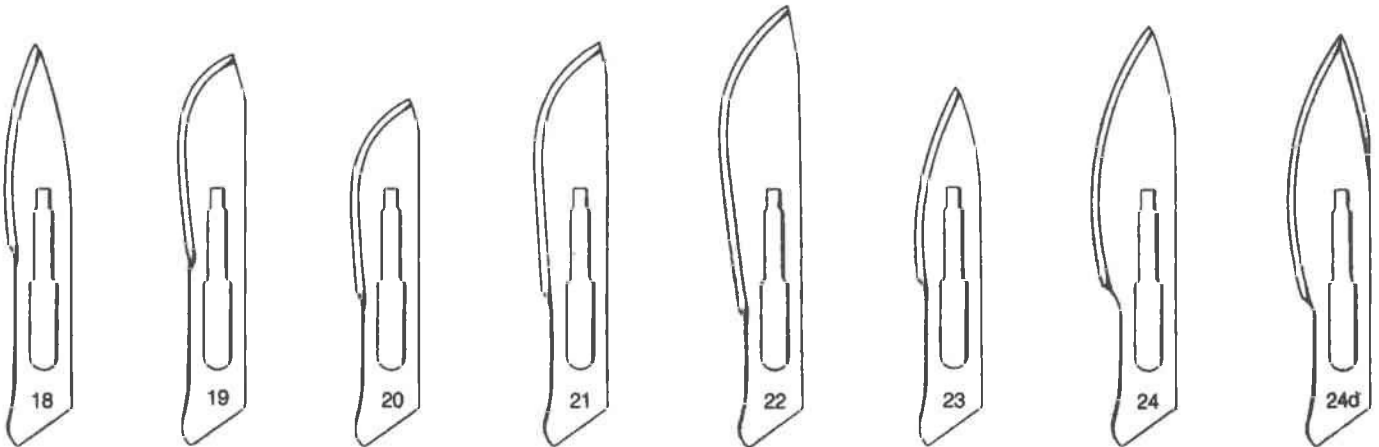

H106-11800 H106-11900 H106-12000 H106-12100 H106-12200 H106-12300 H106-12400 H106-12402

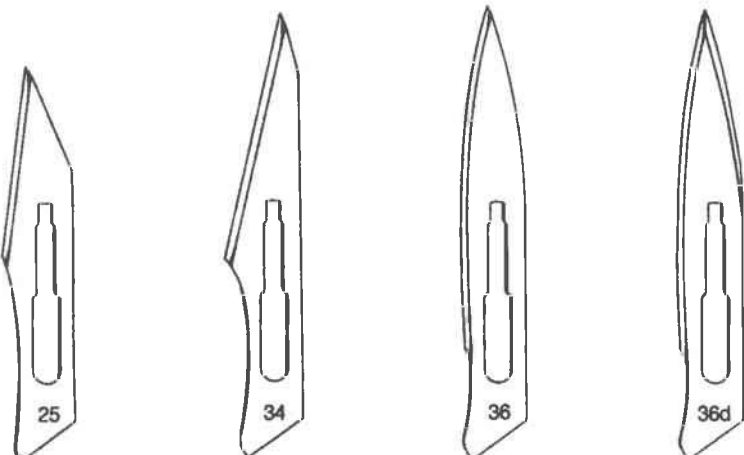

H106-12500 H106-13400 H106-13600 H106-13602



Einmalskalpelle, steril  
Disposable Scalpels, Sterile  
Bistouris usage unique, stériles  
Bisturías uso único, estériles  
Bisturi monouso, sterili

in Packungen à 10 Stück  
in packages of 10 ea  
en boîtes de 10 pièces  
en cajas de 10 c/u  
in scatole di 10 pezzi



H106-21000  
Fig. 10



H106-21100  
Fig. 11



H106-21200  
Fig. 12



H106-21202  
Fig. 12d



H106-21300  
Fig. 13



H106-21500  
Fig. 15



H106-21501  
Fig. 15c



H106-21800  
Fig. 18



H106-21900  
Fig. 19



H106-22000  
Fig. 20



H106-22100  
Fig. 21



H106-22200  
Fig. 22



H106-22300  
Fig. 23



H106-22400  
Fig. 24



H106-22500  
Fig. 25

Klingenbrecher, Rasierklingen  
Blade Breakers, Razor Blades  
Casse-lames, rasoirs  
Rompe-hojas, hojas de afeitar  
Pinze rompe-lamette, lamette

100



TROUTMAN-CHRIS  
H106-29009  
9 cm



DIMEDA  
H106-29111  
11 cm



CASTROVIEJO  
H106-29413  
13 cm



Package = 10 ea  
Boîte = 10  
Cajita = 10 c/u  
Scatola = 10

Skalpelle mit Metallheft  
Scalpels with Metal Handle  
Bistouris, manche métal  
Bisturías, mango metálico  
Bisturi, manico di metallo

06

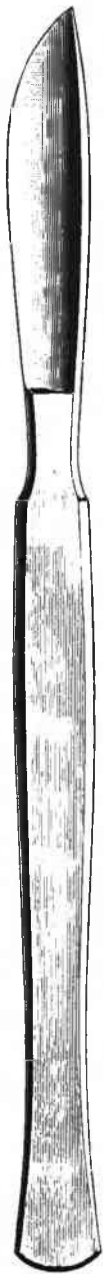

H106-40201  
Fig. 1



H106-40202  
Fig. 2

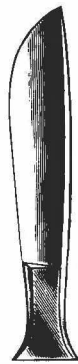

H106-40203  
Fig. 3



H106-40204  
Fig. 4



H106-40205  
Fig. 5



H106-40206  
Fig. 6



H106-40207  
Fig. 7



H106-40208  
Fig. 8



H106-40209  
Fig. 9



H106-40210  
Fig. 10



H106-40201 - H106-40210



PARKER  
H106-40801  
Fig. 1



PARKER  
H106-40802  
Fig. 2

Resektionsmesser  
Resection knives  
Couteaux à résection  
Cuchillos p. resección  
Coltelli per resezione

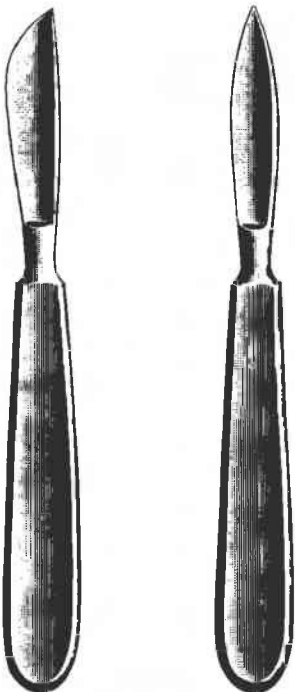

LANGENBECK  
H106-41005  
L = 5,5 cm

LANGENBECK  
H106-41205  
L = 5,5 cm

L = Klingenlänge/length of blade/  
longueur tranchant/largo de corte/  
lunghezza di taglio

Amputationsmesser  
Amputating knives  
Couteaux à amputation  
Cuchillos para amputación  
Coltelli per amputazione

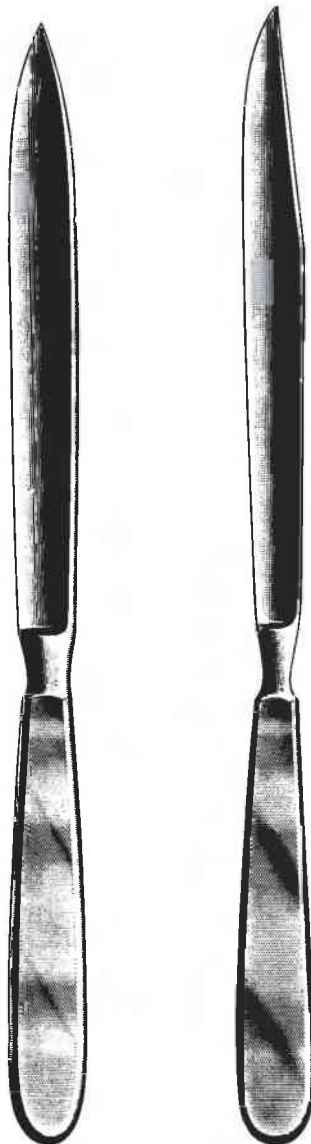

L = cm  
13 H106-42013  
16 H106-42016  
19 H106-42019  
22 H106-42022  
28 H106-42028

L = cm LISTON  
17 H106-43017  
20 H106-43020

Dermatom  
Dermatome  
Dermatome  
Dermátomo  
Dermatomo



SCHINK  
H106-49000  
30 cm compl.



H106-49001

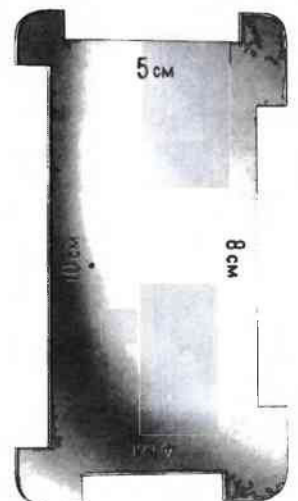

H106-49002



Allgemeine Chirurgie  
General Surgery  
Chirurgie générale  
Cirugía general  
Chirurgia generale

06

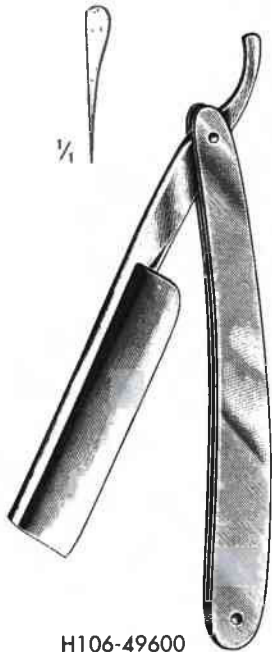

Rasiermesser  
Razor  
Rasoir  
Navaja  
Rasoio

H106-49600



Abziehstein  
Oil stone  
Pierre à repasser  
Piedra afiladora  
Pietra per affilare

Arkansas  
H106-49900



VIRCHOW  
H106-96025



L = cm  
16 H106-98016  
20 H106-98020  
24 H106-98024

Knorpel-, Hirnmesser  
Cartilage, brain knife  
Couteaux à cartilage, à cerveau  
Cuchillo para cartilagos y p. cerebro  
Coltelli per cartilagini e per il cervello



Chirurgische Scheren  
Operating Scissors  
Ciseaux à chirurgie  
Tijeras para cirugía  
Forbici per chirurgia

TC Schneiden  
TC Cutting Edges  
Tranchant TC  
Filos de corte TC  
Taglio TC

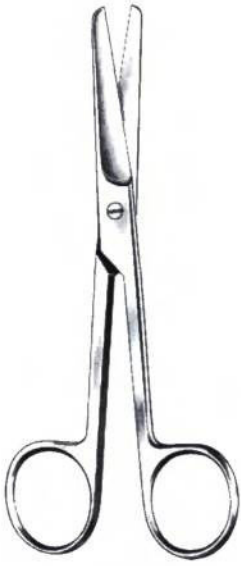

cm	Standard	TC	Standard	TC	Standard	TC
10,5	H108-10210		H108-11010		H108-12010	
11,5	H108-10211		H108-11011		H108-12011	
13,0	H108-10213		H108-11013		H108-12013	
14,5	H108-10214	H108-10414	H108-11014	H108-11414	H108-12014	H108-12414
15,5	H108-10215		H108-11015		H108-12015	
16,5	H108-10216	H108-10416	H108-11016	H108-11416	H108-12016	H108-12416
18,5	H108-10218		H108-11018			
20,0	H108-10220		H108-11020			

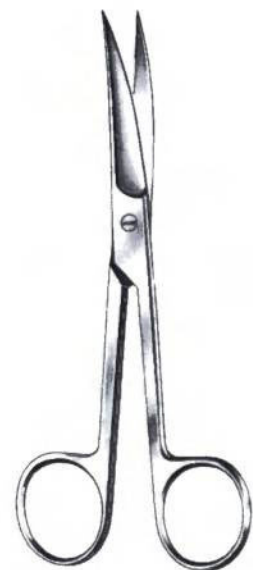

cm	Standard	TC	Standard	TC	Standard	TC
11,5	H108-10311		H108-11111		H108-12111	
13,0	H108-10313		H108-11113		H108-12113	
14,5	H108-10314	H108-10514	H108-11114	H108-11514	H108-12114	H108-12514
15,5	H108-10315		H108-11115		H108-12115	
16,5	H108-10316	H108-10516	H108-11116	H108-11516	H108-12116	H108-12516
18,5	H108-10318		H108-11118			
20,0	H108-10320		H108-11120			

Chirurgische Scheren  
Operating Scissors  
Ciseaux à chirurgie  
Tijeras para cirugía  
Forbici per chirurgia

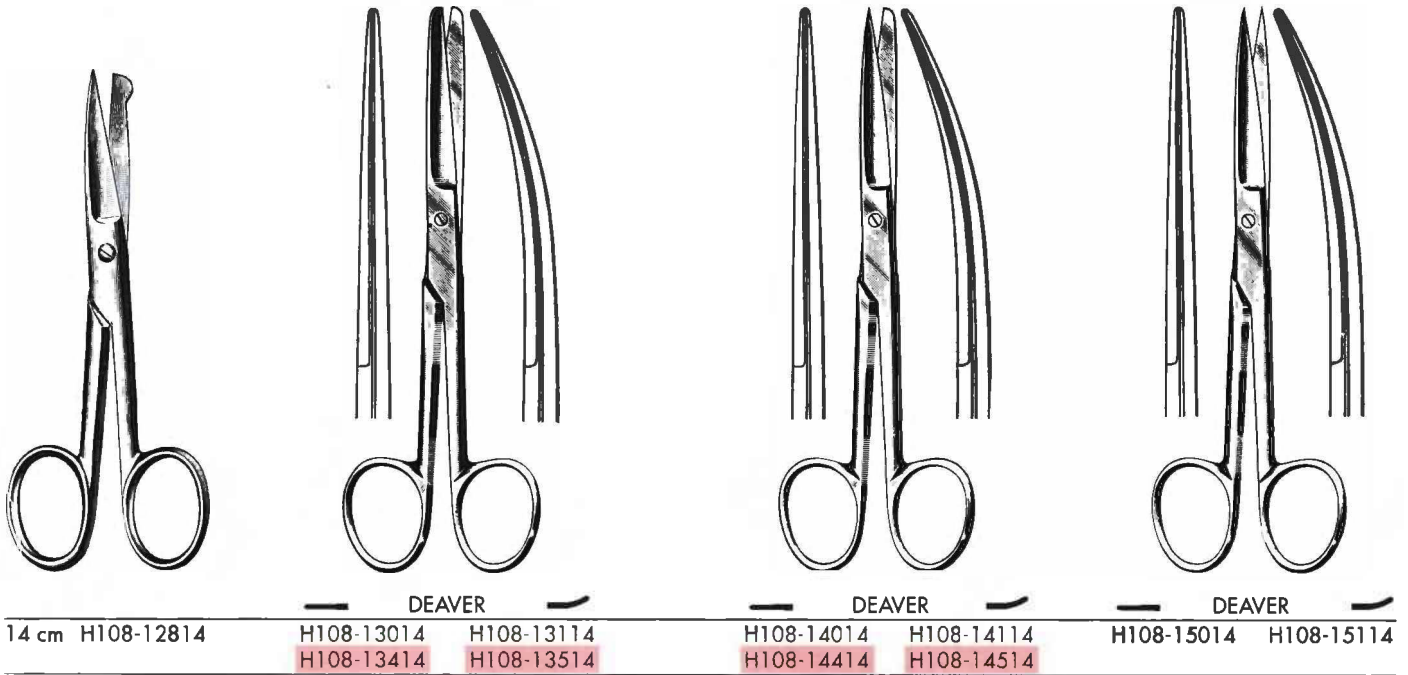

14 cm H108-12814

DEAVER  
H108-13014 H108-13114  
H108-13414 H108-13514

DEAVER  
H108-14014 H108-14114  
H108-14414 H108-14514

DEAVER  
H108-15014 H108-15114

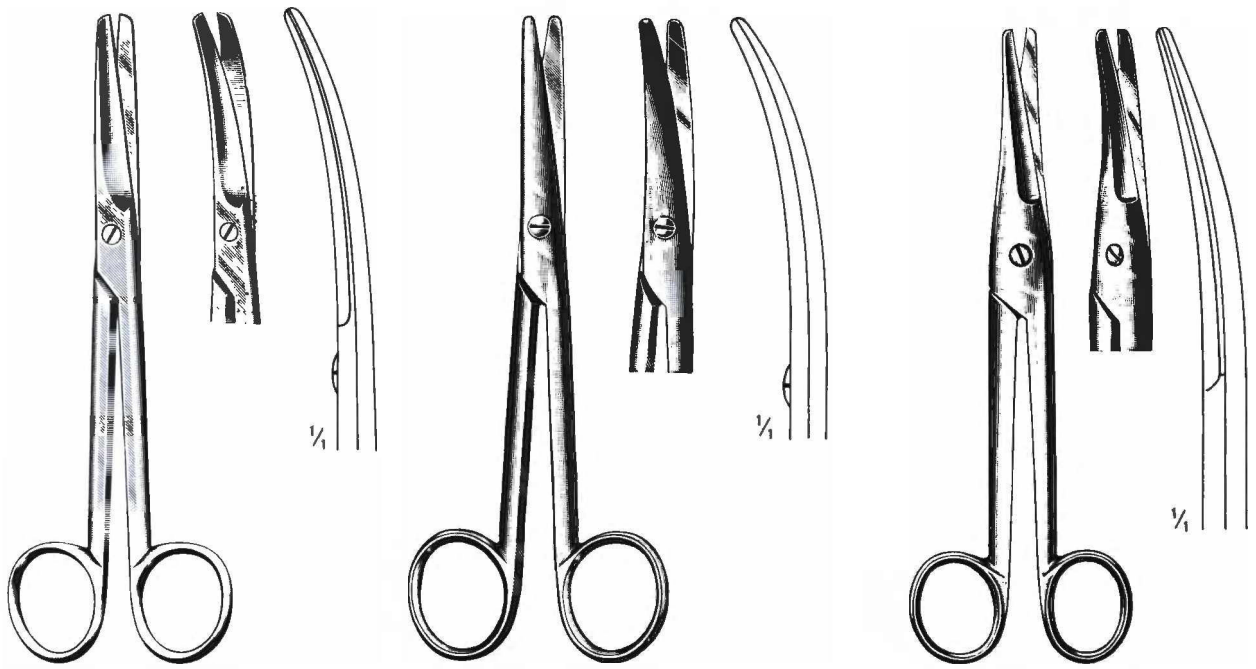

cm MAYO  
14,5 H108-16014 H108-16114  
H108-16414 H108-16514  
17,0 H108-16017 H108-16117  
H108-16417 H108-16517  
20,0 H108-16020  
23,0 H108-16023 H108-16123  
H108-16423 H108-16523

cm MAYO-STILLE  
15,0 H108-17015 H108-17115  
H108-17415 H108-17515  
17,0 H108-17017 H108-17117  
17,0 H108-17417 H108-17517

MAYO-NOBLE  
H108-18017 H108-18117



Präparierscheren  
Dissecting Scissors  
Ciseaux à dissection  
Tijeras de disección  
Forbici per dissezione

TC Schneiden  
TC Cutting Edges  
Tranchant TC  
Filos de corte TC  
Taglio TC

108

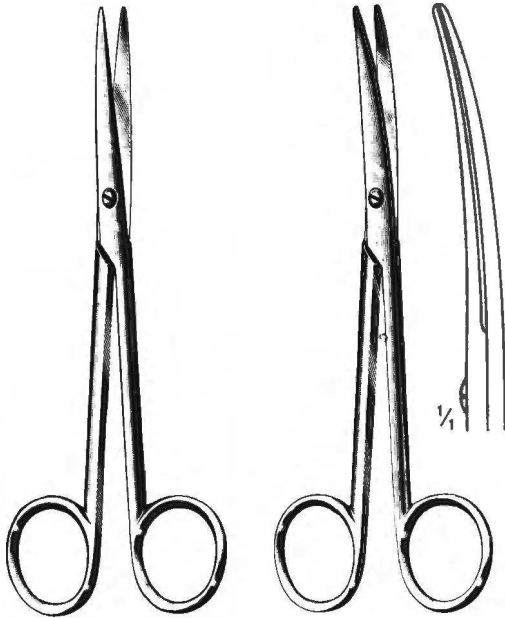

cm	LEXER		LEXER	
16	H108-19016	H108-19416	H108-19116	H108-19516
21	H108-19021	H108-19421	H108-19121	H108-19521

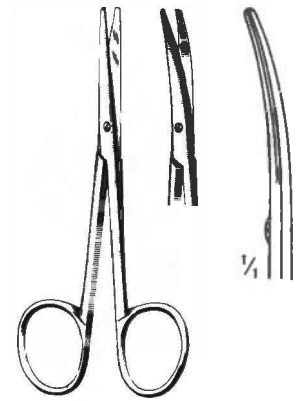

cm	LEXER BABY	
10	H108-20210	H108-20310
	H108-20610	H108-20710

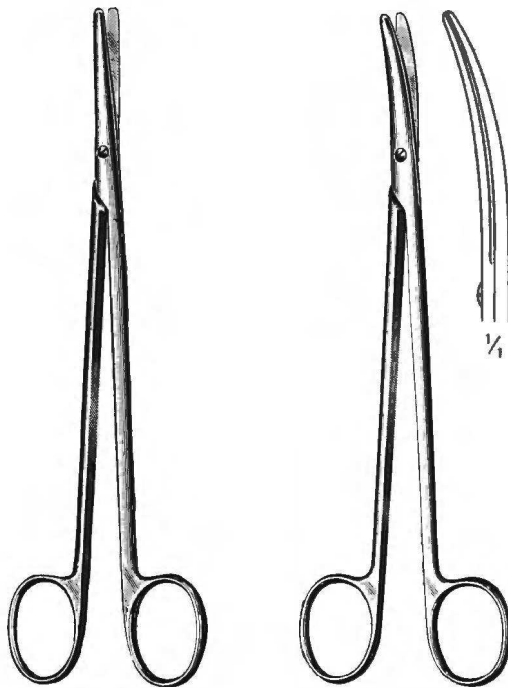

cm	METZENBAUM		METZENBAUM	
15	H108-28015	H108-28415	H108-28115	H108-28515
18	H108-28018	H108-28418	H108-28118	H108-28518
20	H108-28020	H108-28420	H108-28120	H108-28520
23	H108-28023	H108-28423	H108-28123	H108-28523
25	H108-28025	H108-28425	H108-28125	H108-28525
28	H108-28028	H108-28428	H108-28128	H108-28528
30	H108-28030	H108-28430	H108-28130	H108-28530

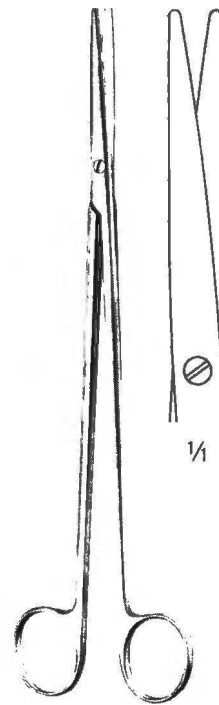

cm	METZENBAUM FINO		METZENBAUM FINO	
15	H108-28215	H108-28615	H108-28315	H108-28715
18	H108-28218	H108-28618	H108-28318	H108-28718
20	H108-28220	H108-28620	H108-28320	H108-28720
23	H108-28223	H108-28623	H108-28323	H108-28723
25		H108-28625		H108-28725
28		H108-28628		H108-28728

Chirurgische Scheren  
Operating Scissors  
Ciseaux à chirurgie  
Tijeras para cirugía  
Forbici per chirurgia



**METZENBAUM "S"**  
18 cm H108-29118  
H108-29518

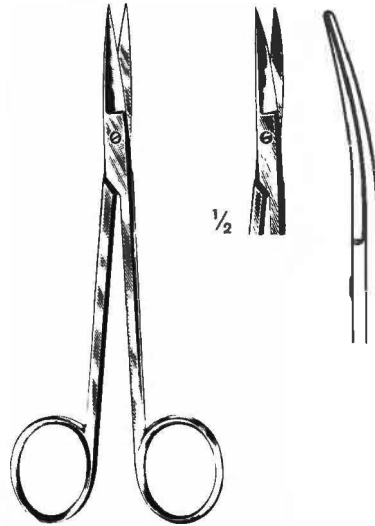

**SANVENERO**  
H108-30214 14 cm H108-30314

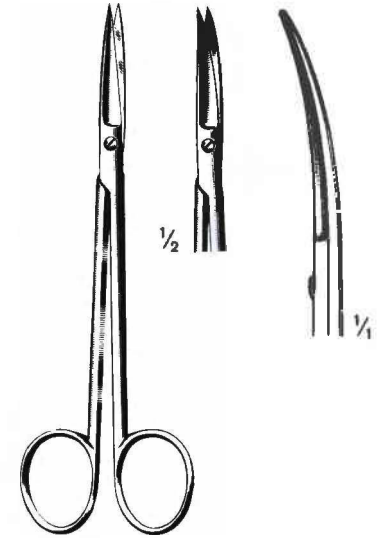

**JOSEPH**  
H108-30414 14 cm H108-30514

Plastik · Plastic · Plastique  
Plástica · Plastica

Plastik · Plastic · Plastique  
Plástica · Plastica

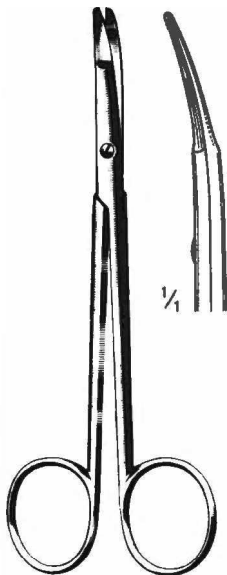

**KILNER**  
cm  
12 H108-31012 H108-31412  
15 H108-31015 H108-31415

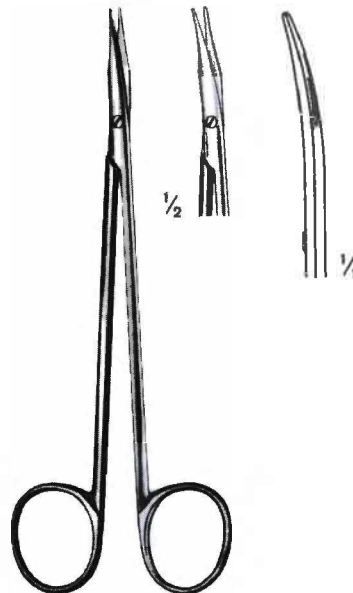

**REYNOLDS**  
H108-32015 15 cm H108-32115  
H108-32415 H108-32515

Iris - Standard

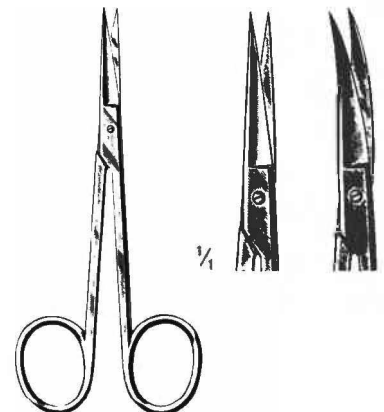

**Iris - Standard**  
H108-34009 9 cm H108-34109  
H108-34011 11,5 cm H108-34111  
H108-34411 H108-34511

Scheren, Ophthal., Nase  
Scissors, Ophthal., Nasal  
Ciseaux, ophtal., nasaux  
Tijeras, oftalmología, nasales  
Forbici, oftalmologia, nasali

08

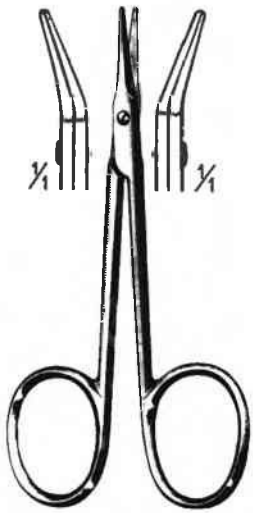

AEBLI  
H108-34709 9 cm H108-34909



STEVENS  
11 cm

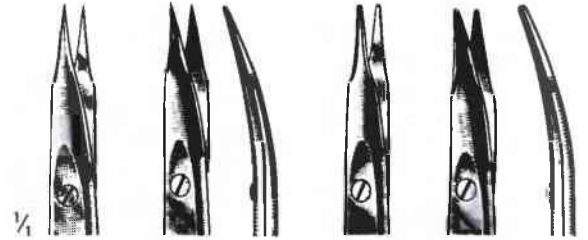

H108-36011 H108-36111 H108-36211 H108-36311

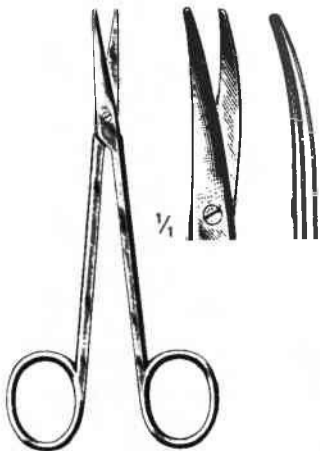

H108-37011 11 cm H108-37111  
H108-37411 H108-37511

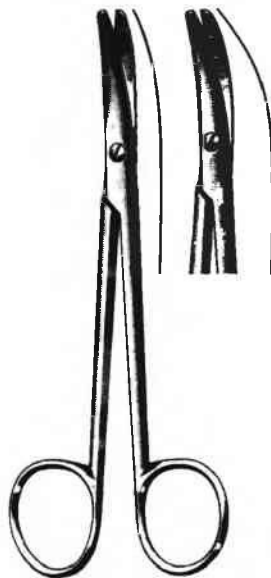

H108-38111 11 cm H108-38311

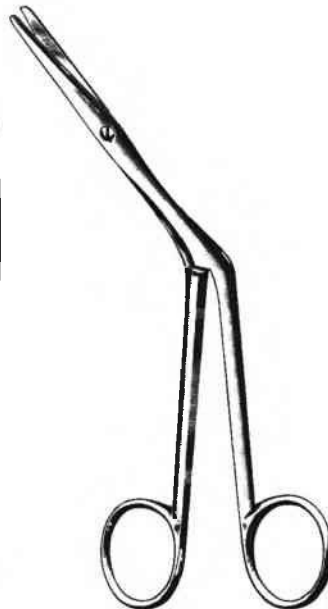

HEYMANN  
H108-40118  
18 cm

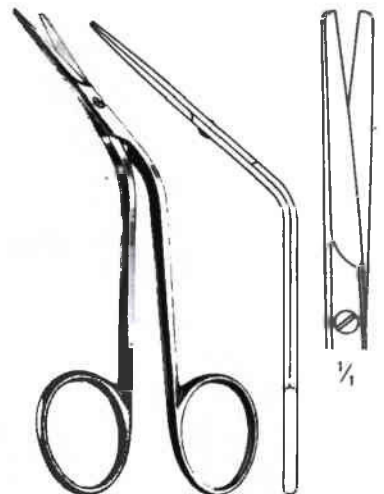

FOMON  
H108-40315  
15 cm

Tonsillen-, Gefäß-Scheren  
Tonsil, Vascular Scissors  
Ciseaux amygdal., vasculaires  
Tijeras, amígdal., vasculares  
Forbici, tonsill., vascolari

Nase · Nasal · Nasale

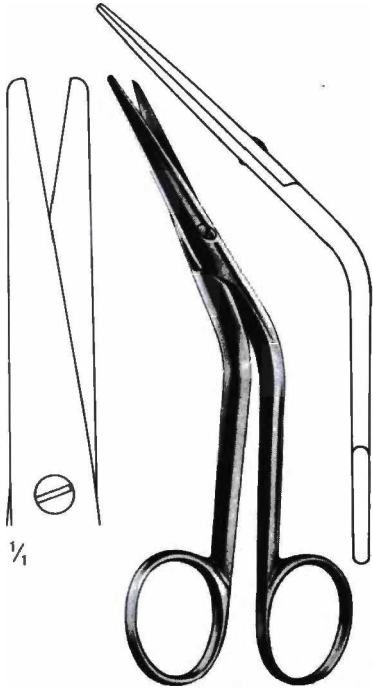

**COTTLE**  
H108-40516  
16 cm

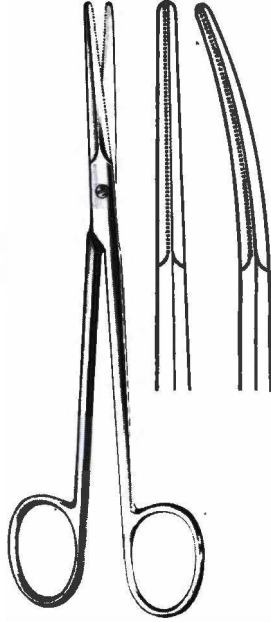

**BEUSE**  
H108-42014 14 cm H108-42114  
H108-42018 18 cm H108-42118

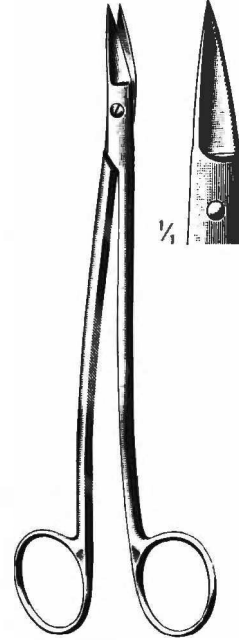

**DEAN**  
H108-42517 17 cm H108-42717

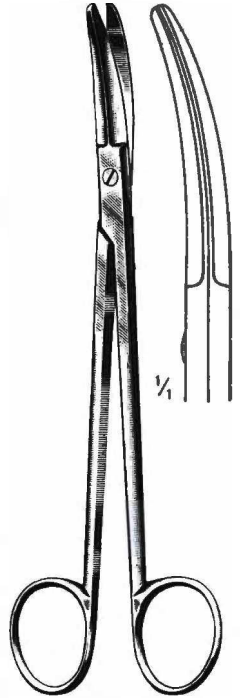

**BOETTCHER**  
H108-43518  
18 cm

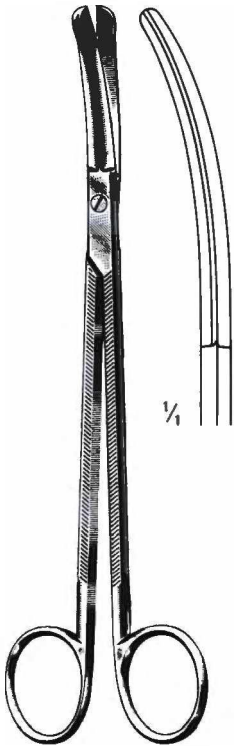

**GOOD**  
H108-43719  
19 cm

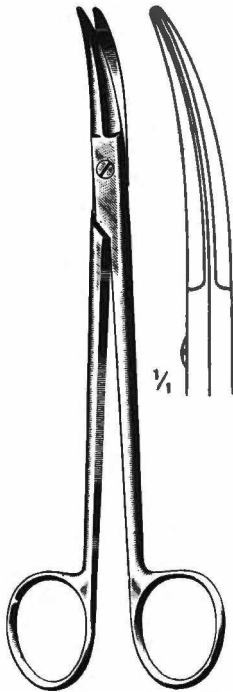

**PRINCE**  
H108-43917  
17 cm

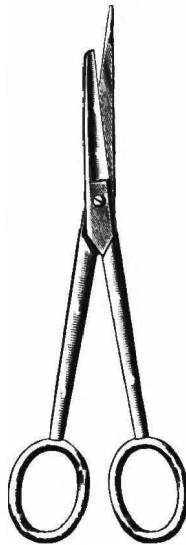

H108-46815  
15 cm

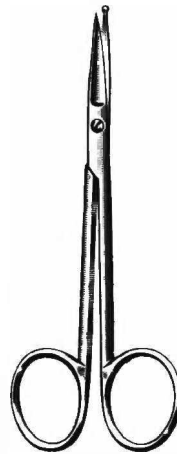

H108-47011  
11 cm

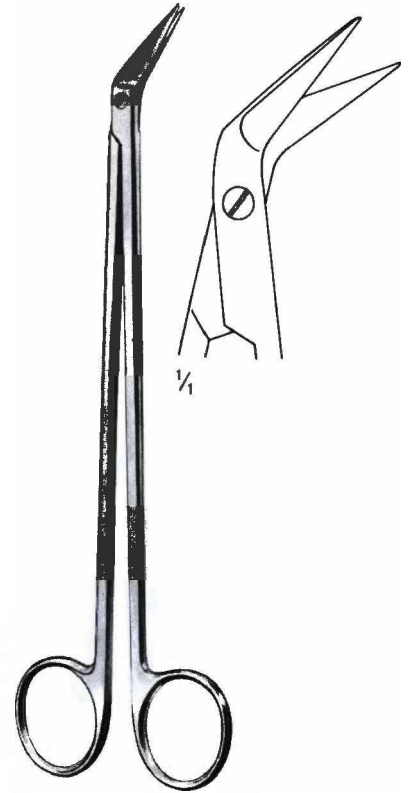

cm **POTTS-DE MARTEL**  
21 H108-47321  
24 H108-47324



Gefäß-Scheren  
Vascular Scissors  
Ciseaux vasculaires  
Tijeras vasculares  
Forbici vascolari

08

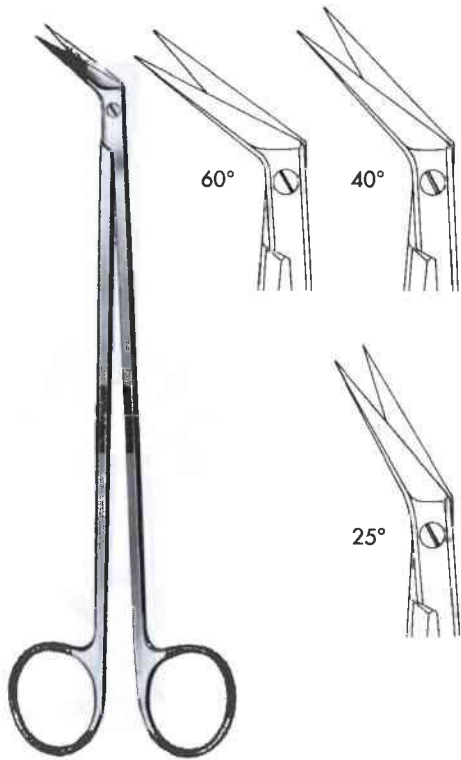

∠	POTTS-SMITH, 19 cm	
25°	H108-48025	H108-48425
40°	H108-48040	H108-48440
60°	H108-48060	H108-48460

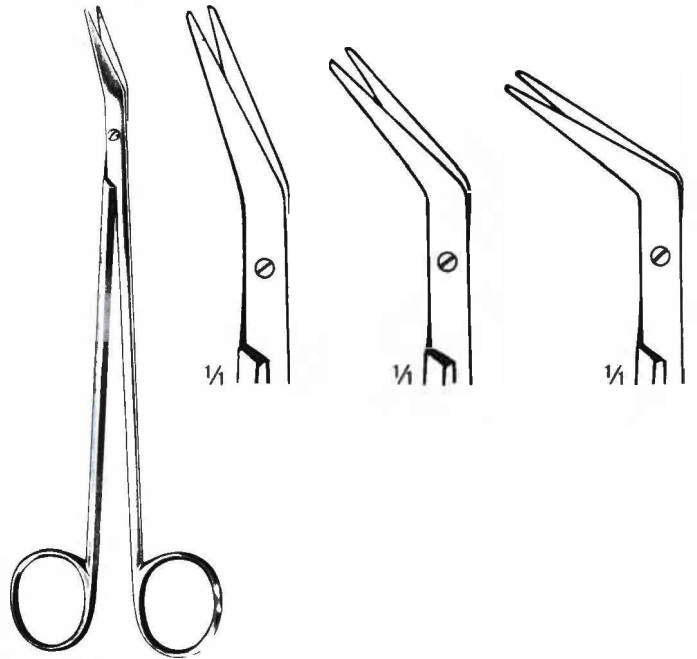

cm	DE BAKEY	25°	45°	60°
16		H108-49016	H108-49116	H108-49216
23		H108-49023	H108-49123	H108-49223
28		H108-49028	H108-49128	H108-49228

Parametrium · parametrio

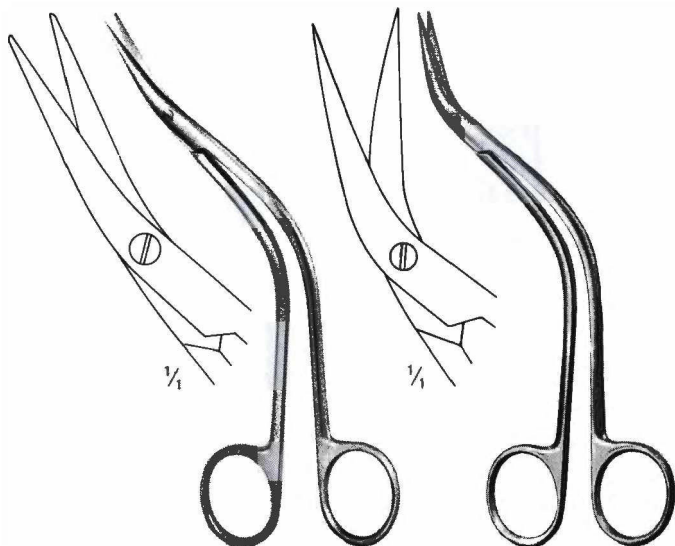

DE BAKEY  
H108-49515  
15,5 cm

DE BAKEY  
H108-49715  
15,5 cm



H108-50122  
H108-50522  
22,5 cm

H108-50123  
H108-50523  
23 cm

H108-50122 - H108-50523

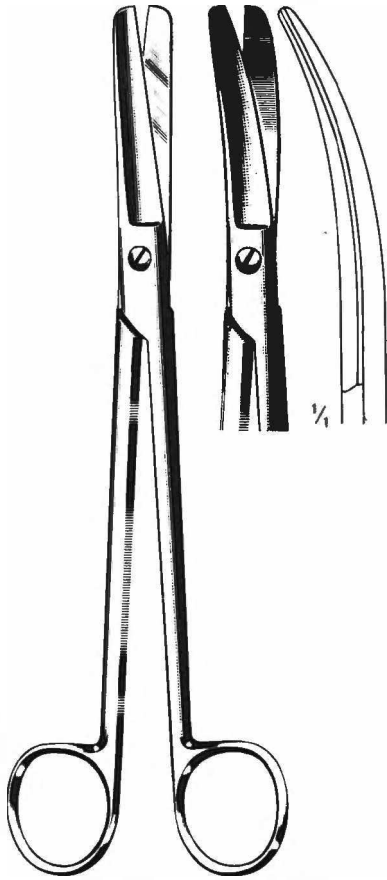

cm	SIMS	
20	H108-51020	H108-51120
23	H108-51023	H108-51123
	H108-51423	H108-51523

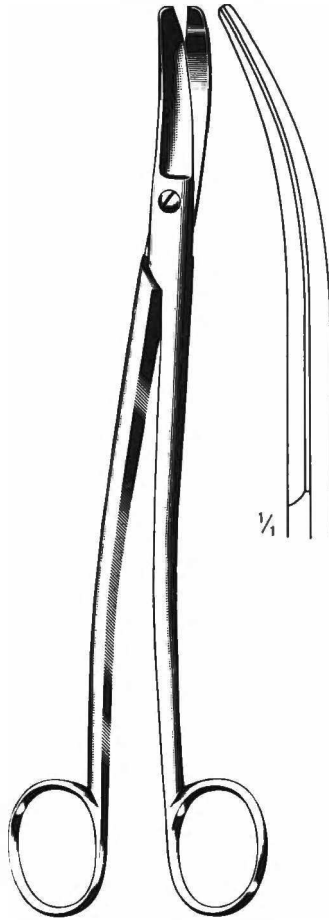

SIEBOLD  
H108-52324  
24 cm

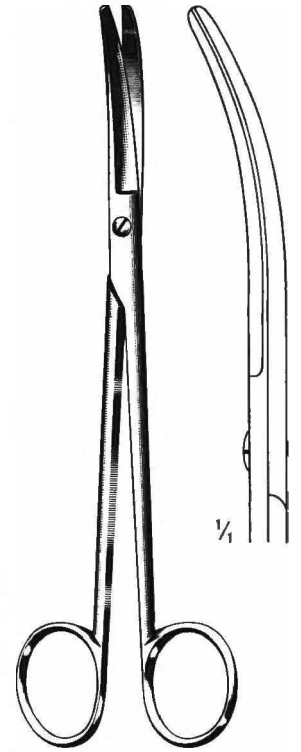

WERTHEIM  
H108-52522  
22,5 cm

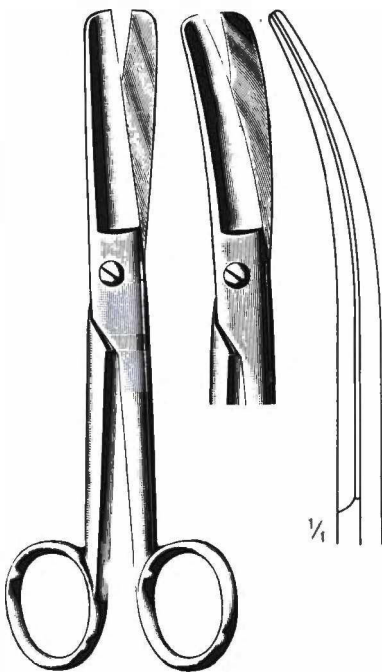

cm	DOYEN	
17,5	H108-53017	H108-53117

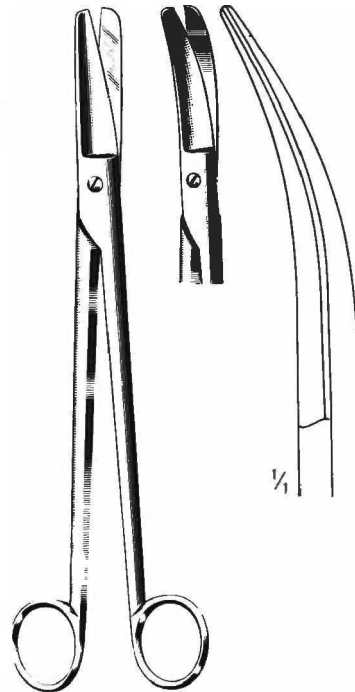

cm	DUBOIS	
27	H108-53627	H108-53727

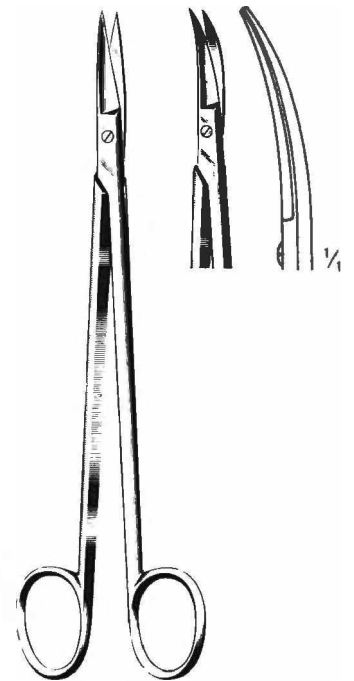

cm	KELLY	
16	H108-54016	H108-54116
18	H108-54018	H108-54118

Chirurgische Scheren  
Operating Scissors  
Ciseaux à chirurgie  
Tijeras para cirugía  
Forbici per chirurgia

08

Nabelschnur-Scheren  
Umbilical Scissors  
Ciseaux ombilicaux  
Tijeras umbilicales  
Forbici ombelicali

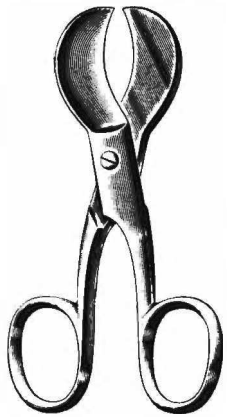

USA Mod.  
H108-55010  
10,5 cm

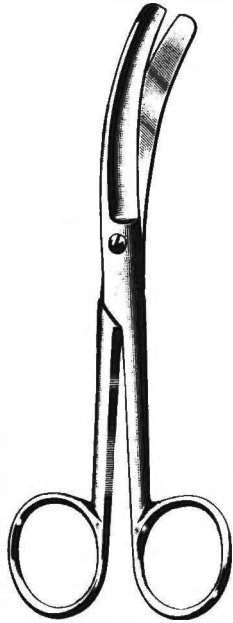

BUSCH  
H108-55116  
16 cm

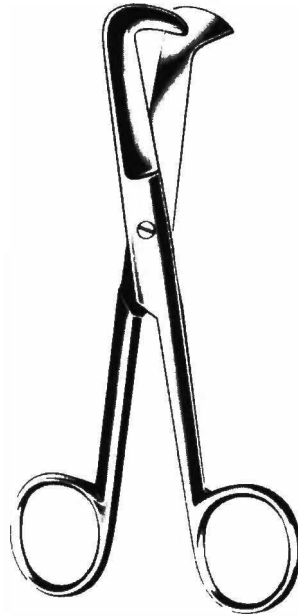

SCHUMACHER  
H108-55316  
14 cm

Episiotomie · Episiotomy  
Episiotomia



cm	BRAUN-STADLER
14,5	H108-56014
22,0	H108-56022

Neurochirurgie · Neurosurgery  
Neurocirurgia · Neurochirurgia

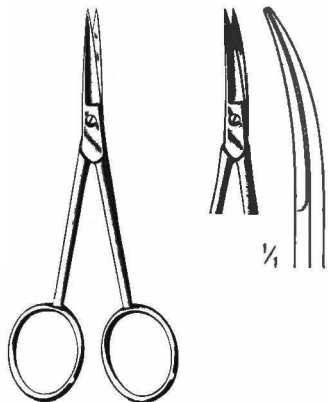

H108-58011 11 H108-58111

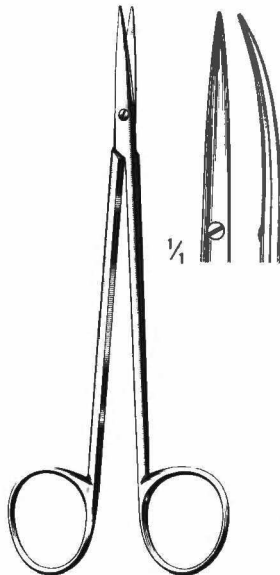

H108-58215 15 H108-58315

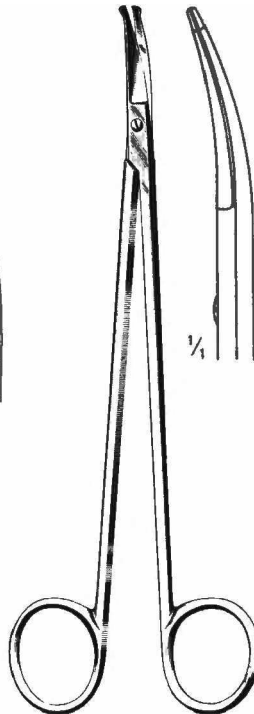

STRULLY  
H108-60122  
22 cm

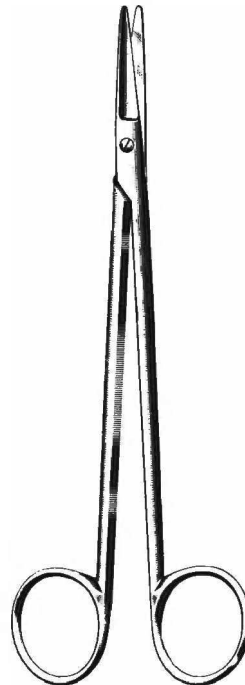

TOENNIS-ADSON  
H108-61018  
18 cm

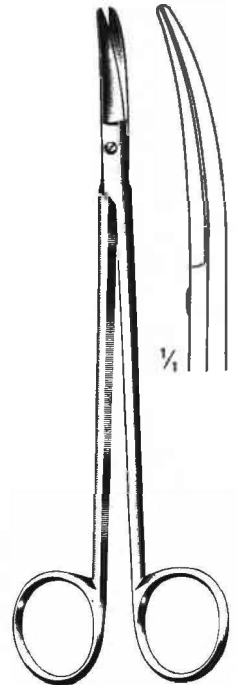

TOENNIS-ADSON  
H108-61118  
18 cm

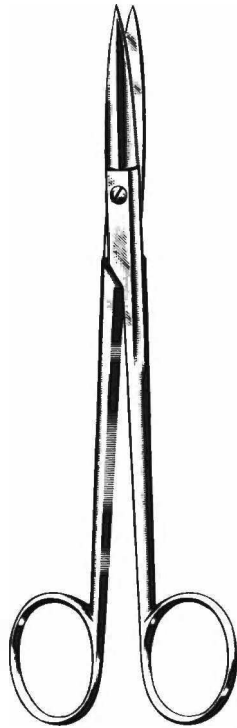

McINDOE  
H108-61419  
19 cm

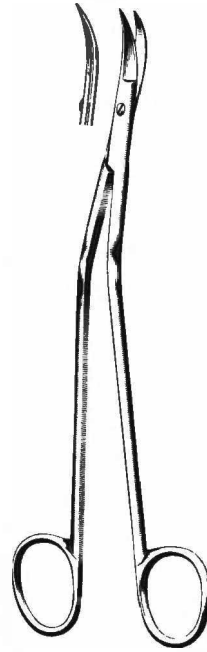

DANDY  
H108-61717  
17 cm

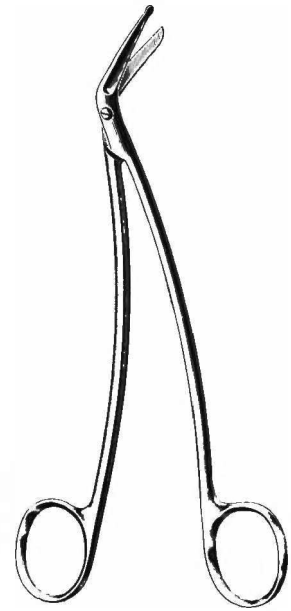

SCHMIEDEN-TAYLOR  
H108-61917  
17 cm

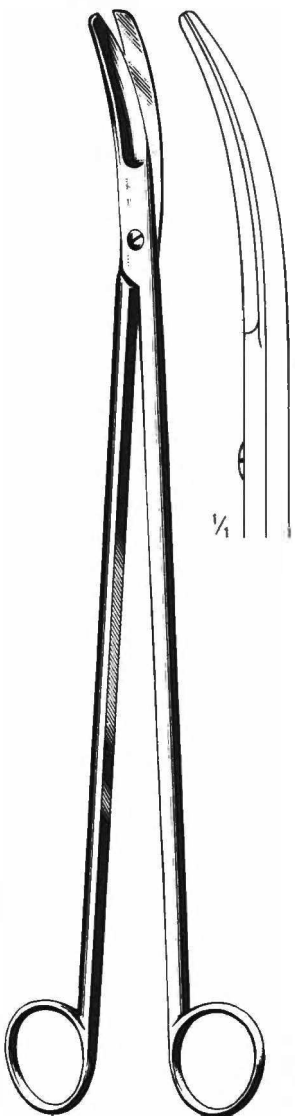

CRAFOORD  
H108-64130  
30 cm

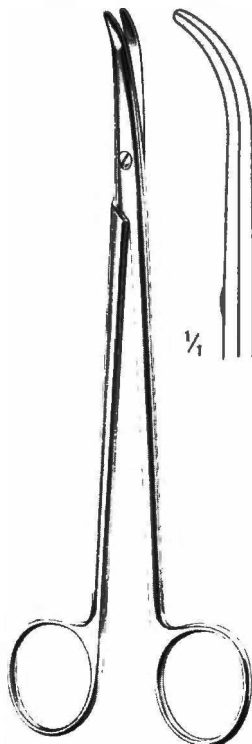

cm	THOREK
19	H108-64318
25	H108-64325

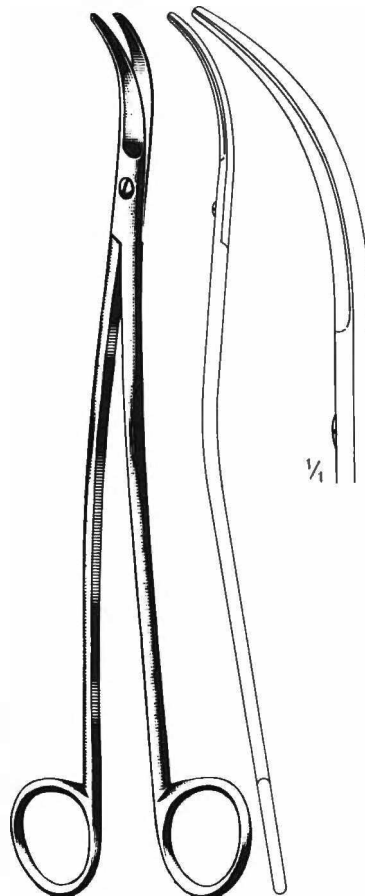

SATINSKY  
H108-65124  
24,5 cm

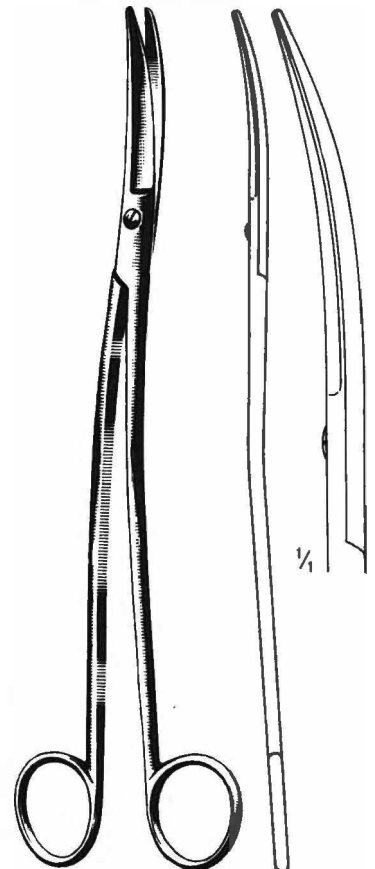

KLINKENBERGH-LOTH  
H108-66123  
23 cm



Chirurgische Scheren  
Operating Scissors  
Ciseaux à chirurgie  
Tijeras para cirugía  
Forbici per chirurgia

08

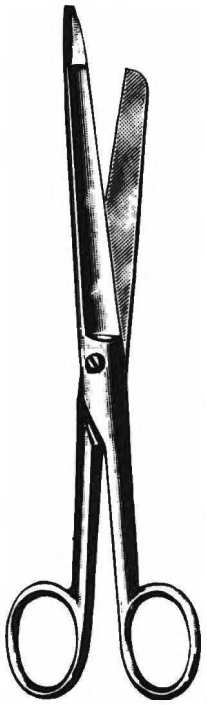

H108-77021  
21 cm

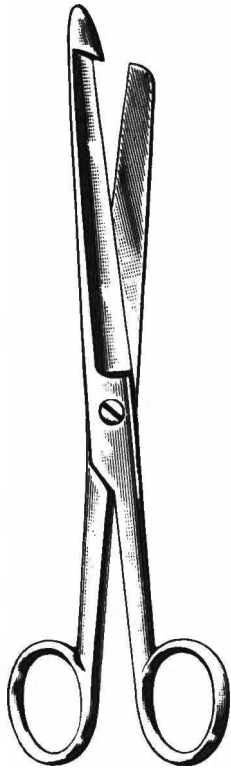

H108-77221  
21 cm

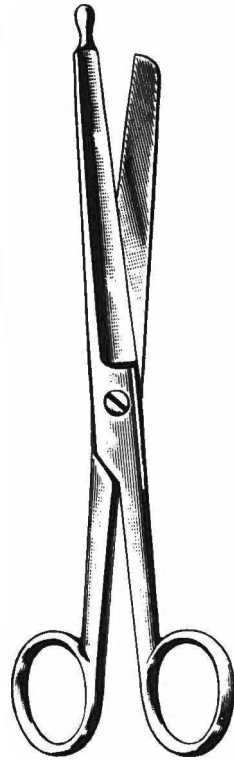

H108-77421  
21 cm

Darmscheren  
Enterotomy Scissors  
Ciseaux à entérotomie  
Enterótomos  
Forbici per enterotomia

Ligaturscheren  
Stitch Scissors  
Ciseaux à ligatures  
Tijeras para puntas  
Forbici per legature

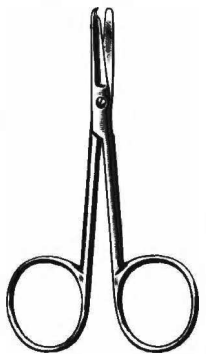

SPENCER  
H108-80209  
9 cm

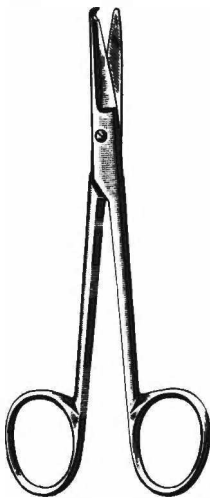

SPENCER  
H108-80211  
11 cm

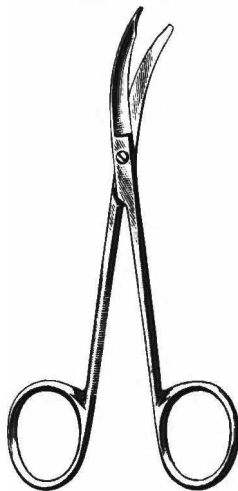

NORTHBENT  
H108-80313  
13 cm

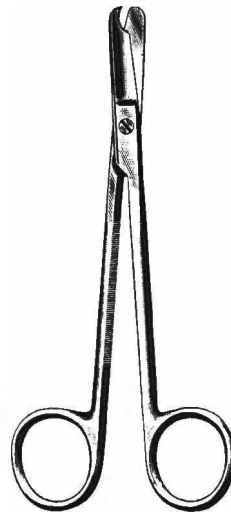

LITTAUER  
H108-80414  
14 cm

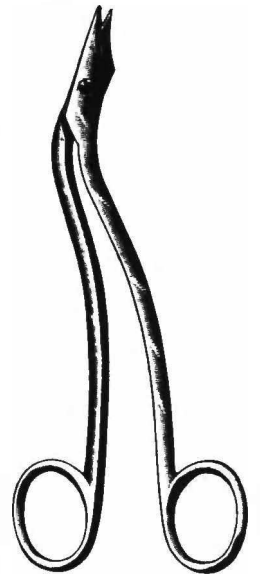

HEATH  
H108-80915  
15 cm

Zahnfleischscheren  
Gum Scissors  
Ciseaux à gencives  
Tijeras para encías  
Forbici gingivali

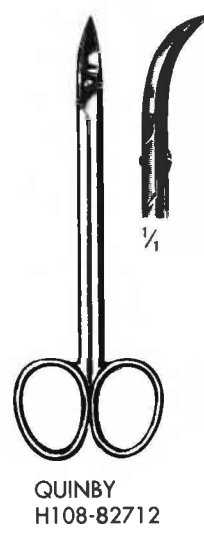
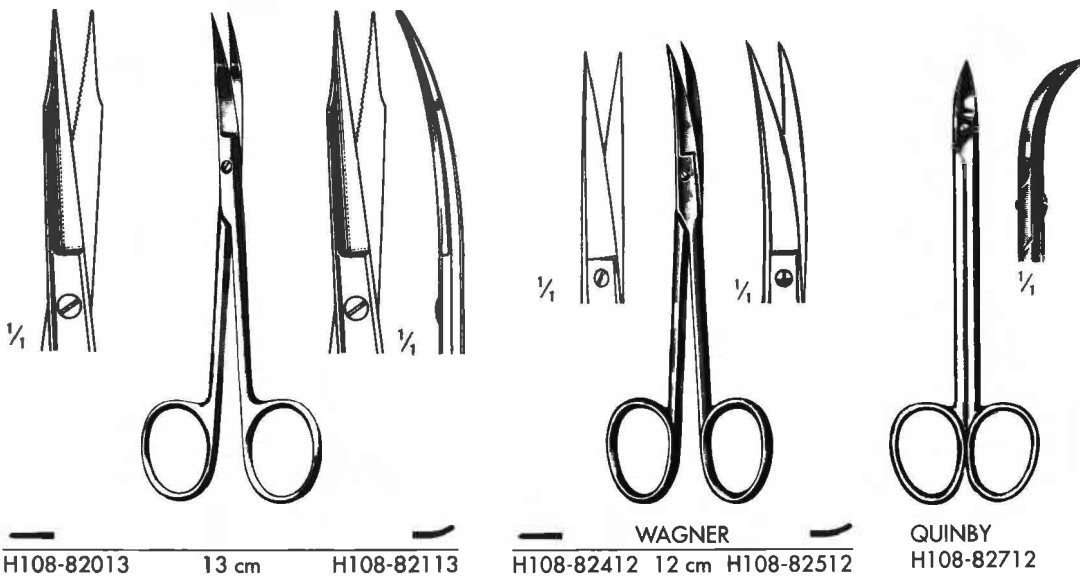

Draht-, Blechscheren  
Wire and plate shears  
Ciseaux à fils et plaques métalliques  
Tijeras para alambre y chapas  
Forbici per filo di metallo e lamiera

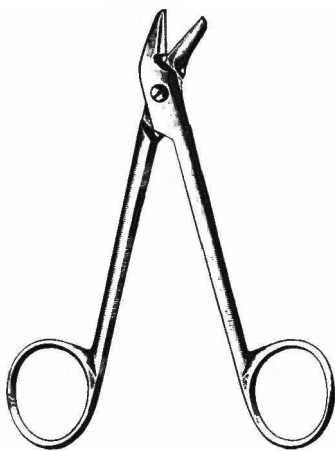

UNIVERSAL  
H108-83112  
H108-83512  
12 cm

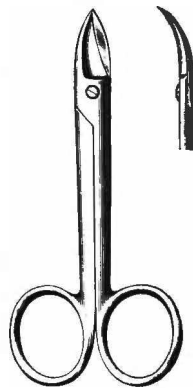

BEEBEE  
H108-85010 10 cm H108-85110  
H108-58012 12 cm H108-85112  
serrated H108-85212 12 cm H108-85312

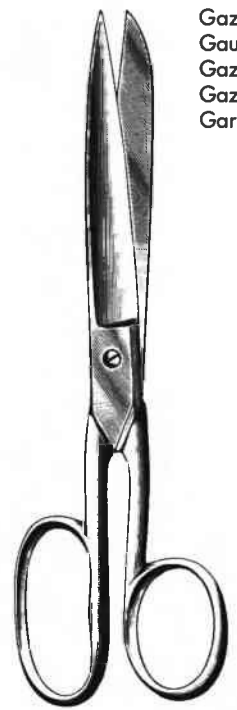

SMITH US ARMY  
H108-89820  
20 cm

Gaze  
Gauze  
Gaze  
Gaza  
Garza

Verband-Scheren  
Bandage Scissors  
Ciseaux à bandages  
Tijeras para vendajes  
Forbici per bendaggi

08

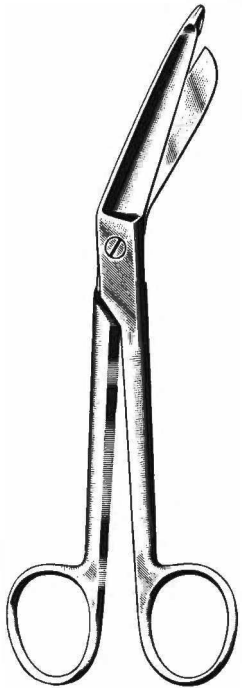

cm **LISTER**  
11 H108-90111  
14 H108-90114  
18 H108-90118  
H108-90518  
20 H108-90120

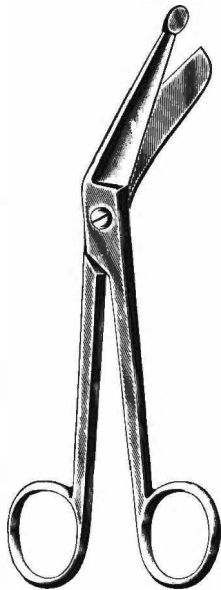

**BERGMANN**  
H108-91123  
23 cm

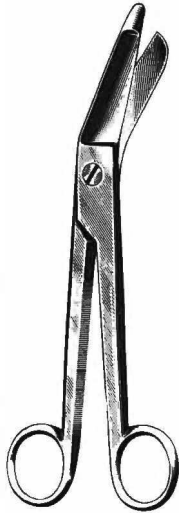

cm **ESMARCH**  
20 H108-91320  
22 H108-91322

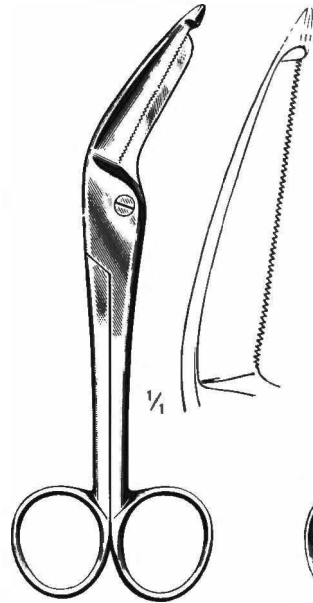

cm **HERMANN Excenter**  
16 H108-92116  
19 H108-92119

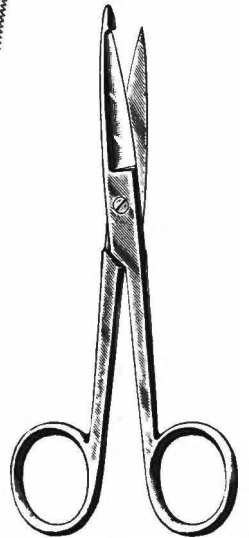

**KNOWLES**  
H108-93014  
14 cm

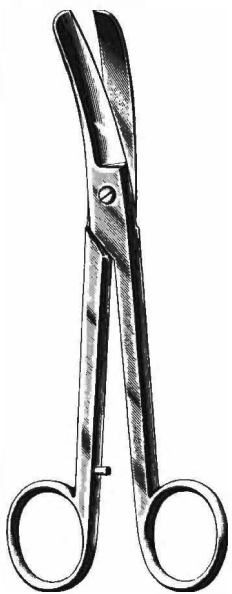

**LORENZ**  
H108-93323  
23 cm

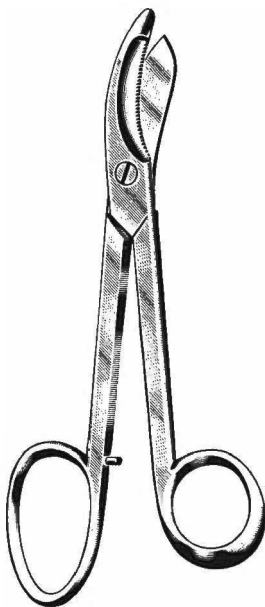

**BRUNS**  
H108-93523 ———  
H108-93723 ~~~~~  
H108-93923  
23 cm

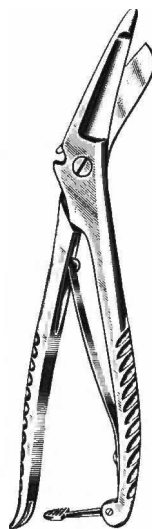

H108-94120  
20 cm



cm **UNIVERSAL**  
15 H108-95015  
18 H108-95018



Augen-Scheren  
Ophthalmic Scissors  
Ciseaux oculaires  
Tijeras oculares  
Forbici oculistiche

Sehnen-, Iris-Scheren  
Tendon, Iris Scissors  
Ciseaux à iris et tendons  
Tijeras iris y para tendones  
Forbici per iride e tendini



WESTCOTT  
H109-10211  
11 cm

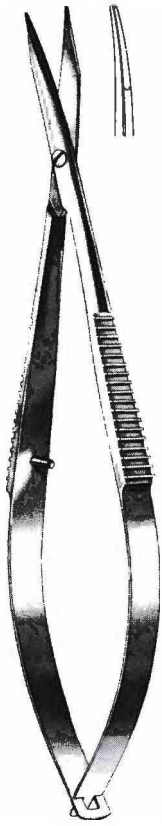

WESTCOTT  
H109-10411  
11 cm

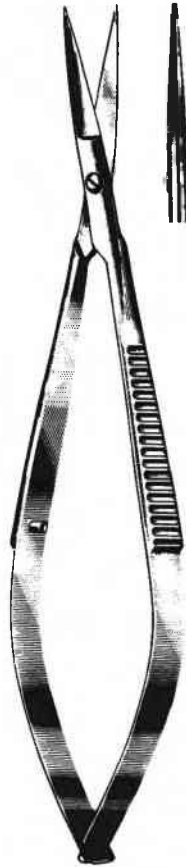

NOYES  
H109-11012  
12 cm



NOYES  
H109-11112  
12 cm  
gebogen  
curved  
courbe

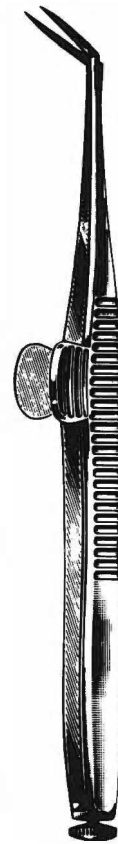

WECKER  
H109-11311 - H109-11711  
11 cm



1311



1511



1711

Hornhautschere  
Corneal scissors  
Ciseaux cornéens  
Tijeras corneales  
Forbici corneali



McGUIRE  
H109-12110  
10 cm

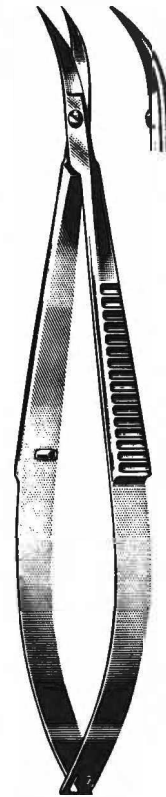

CASTROVIEJO  
H109-13310  
10 cm

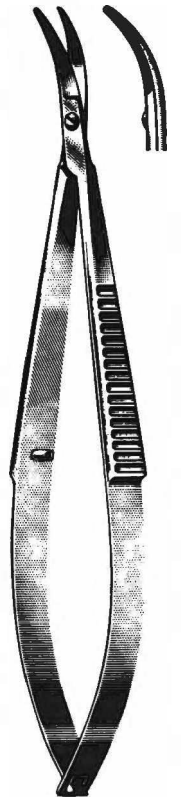

CASTROVIEJO  
H109-13510  
10 cm

Iridektomie · Iridectomy  
Iridectomía

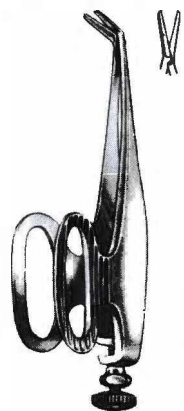

BARRAQUER  
H109-11910  
(Colibri) 5,5 cm, 10 mm



Augen-, Mikro-Scheren  
Ophthalmic, Micro Scissors  
Ciseaux oculaires, micro-ciseaux  
Tijeras oculares, microquirúrgicas  
Forbici oculistiche, micro-chirurg.

Iridektomie, Hornhaut  
Iridectomy, corneal  
Iridectomie, cornéens  
Iridectomía, corneal  
Iridectomia, corneale



VANNAS  
H109-14008  
8 cm



VANNAS  
H109-14108  
8 cm



H109-20218 - H109-20518  
8 mm Ø

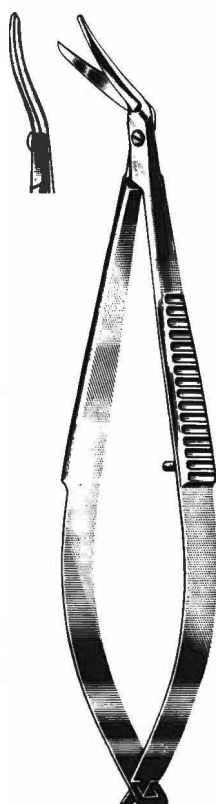

CASTROVIEJO  
H109-15111  
11 cm

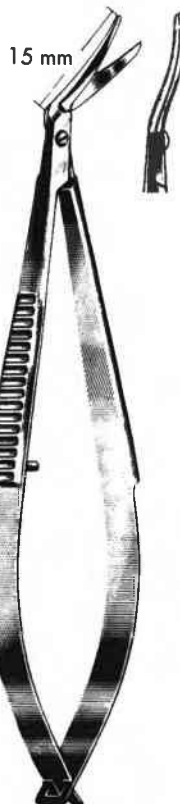

CASTROVIEJO  
H109-15311  
11 cm

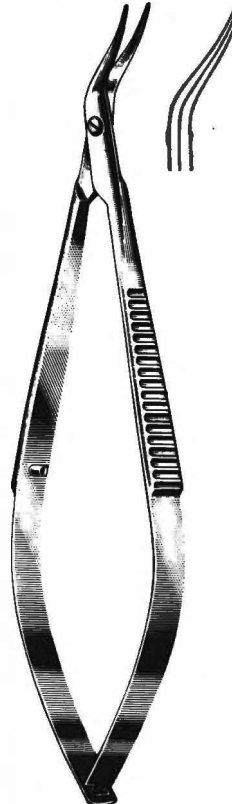

CASTROVIEJO  
H109-15511  
11 cm

Mikrochirurgie  
Micro Surgery  
Microchirurgie  
Microcirugía  
Microchirurgia

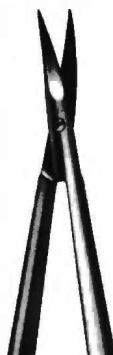

H109-20218 H109-20318  
18 cm



H109-20418 H109-20518  
18 cm (GYN)

Pinzetten  
Thumb and Tissue Forceps  
Pincès à dissection  
Pinzas de disección  
Pinze per dissezione

10

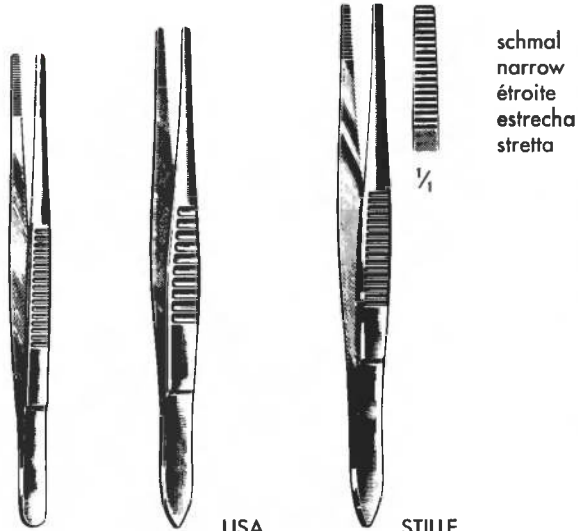

schmal  
narrow  
étroite  
estrecha  
stretta

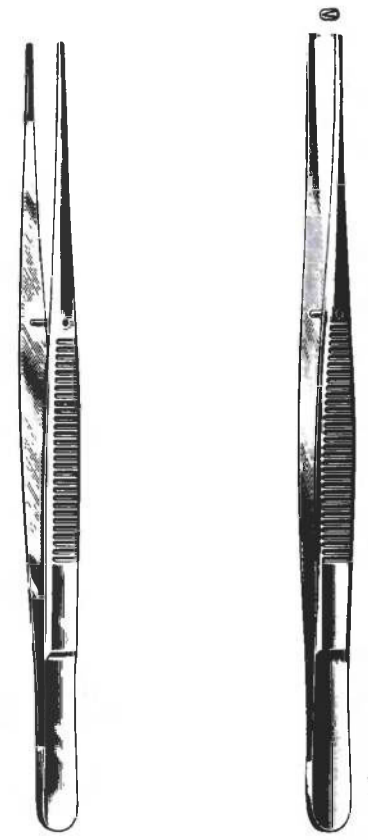

cm	USA	STILLE	POTTS-SMITH	POTTS-SMITH
11,5	H110-10211		H110-11011	
12,0		H110-10412		
13,0	H110-10213	H110-10413	H110-11013	
14,5	H110-10214	H110-10414	H110-11014	H110-11414
15,0		H110-10615		
15,5		H110-10415		
16,0	H110-10216		H110-11016	H110-11416
18,0	H110-10218	H110-10418		H110-11218
20,0	H110-10220		H110-11020	H110-11618
21,0		H110-10421		H110-11221
25,0	H110-10225	H110-10425		H110-11621
30,0	H110-10230			H110-11625
				H110-12621
				H110-12625

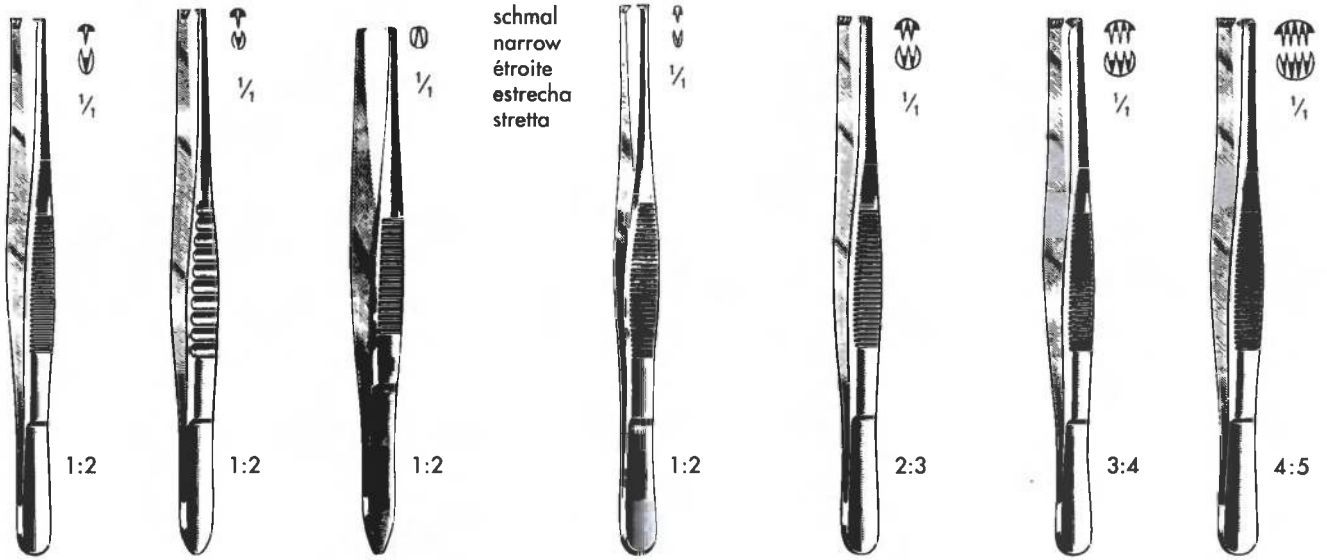

schmal  
narrow  
étroite  
estrecha  
stretta

cm	USA	STILLE				
11,5	H110-12011					
12,0		H110-12212				
13,0	H110-12013	H110-12213	H110-13013	H110-14013	H110-15013	H110-16013
14,5	H110-12014	H110-12214	H110-13014	H110-14014	H110-15014	H110-16014
15,0		H110-12415				
15,5		H110-12215				
16,0	H110-12016		H110-13016	H110-14016	H110-15016	H110-16016
18,0	H110-12018	H110-12218		H110-14018		
20,0	H110-12020			H110-14020		
21,0		H110-12221				
25,0	H110-12025	H110-12225				
30,0	H110-12030			H110-14025		

Pinzetten  
Thumb and Tissue Forceps  
Pinces à dissection  
Pinzas de disección  
Pinze per dissezione

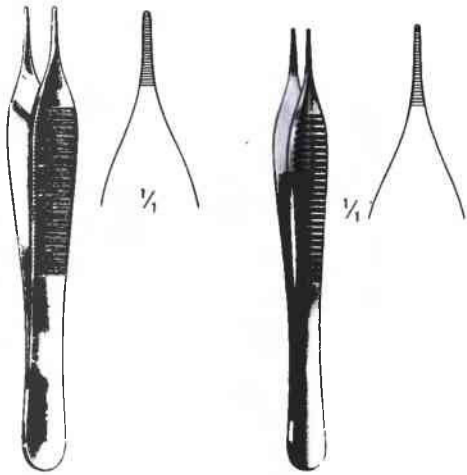

cm	ADSON	ADSON micro
12,0	H110-17012	H110-17612
12,0	H110-17412	
15,0	H110-17015	
15,0	H110-17415	



CUSHING  
H110-22017  
H110-22417  
17 cm

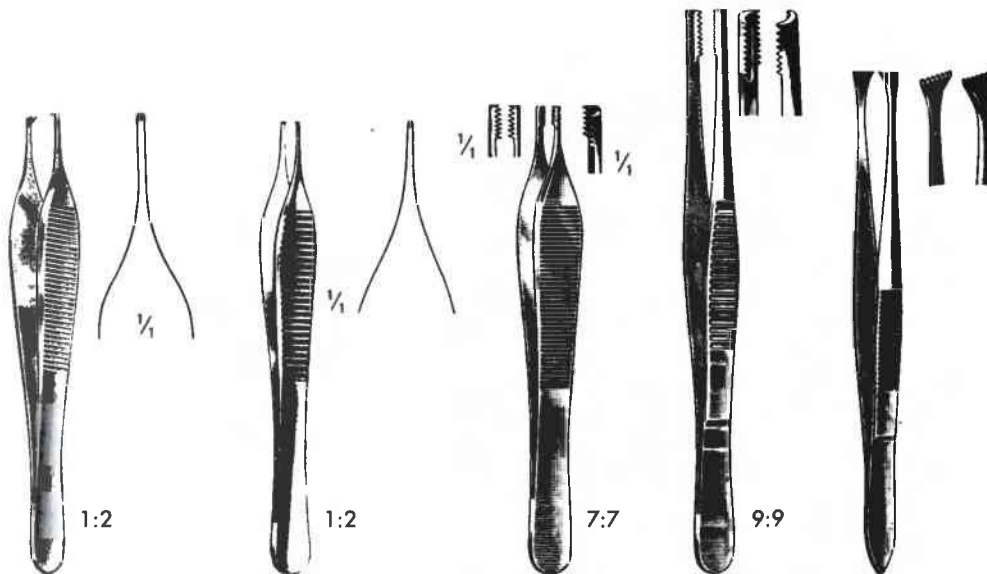

cm	ADSON	ADSON micro	ADSON-BROWN	BROWN	GRAEFE
10,5					H110-19010
12,0	H110-18012	H110-18612	H110-18812		
15,0	H110-18015				
16,0				H110-18916	
20,0				H110-18920	
25,0				H110-18925	



CUSHING  
H110-23017  
17 cm

Pinzetten  
Thumb and Tissue Forceps  
Pincès à dissection  
Pinzas de disección  
Pinze per dissezione

10

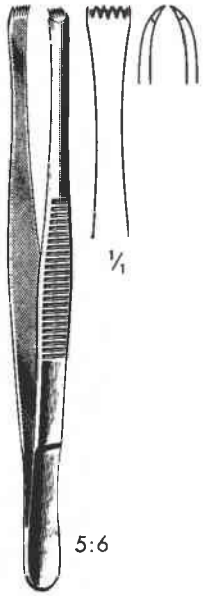

5:6

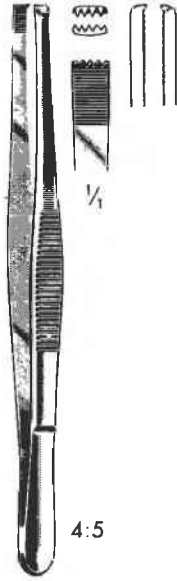

4:5



1:2

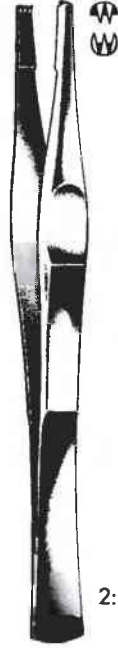

2:3



1:2



2:3

cm	LERCHE	ADLERKREUTZ	LANE	LANE	FERRIS-SMITH	FERRIS-SMITH
14,5			H110-24014	H110-24214		
15,0	H110-23215	H110-23615			H110-24618	H110-24818
18,0						
20,0		H110-23620				

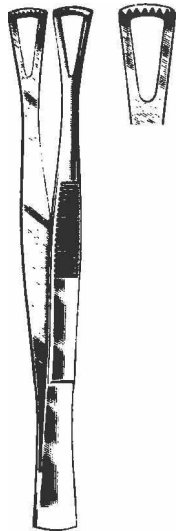

cm	DUVAL
14,5	H110-25014
15,0	
20,0	
25,0	

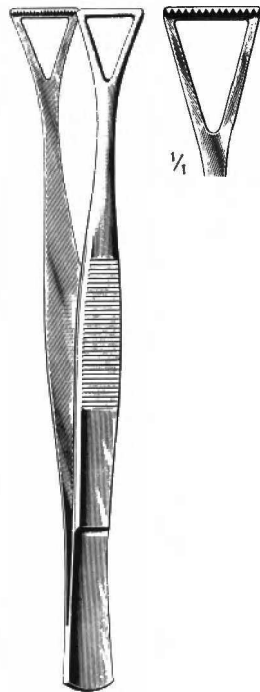

COLLIN-DUVAL
H110-25214



Russ. Mod.
H110-25615
H110-25620
H110-25625



McINDOE
H110-25815

Pinzetten  
Thumb and Tissue Forceps  
Pinces à dissection  
Pinzas de disección  
Pinze per dissezione

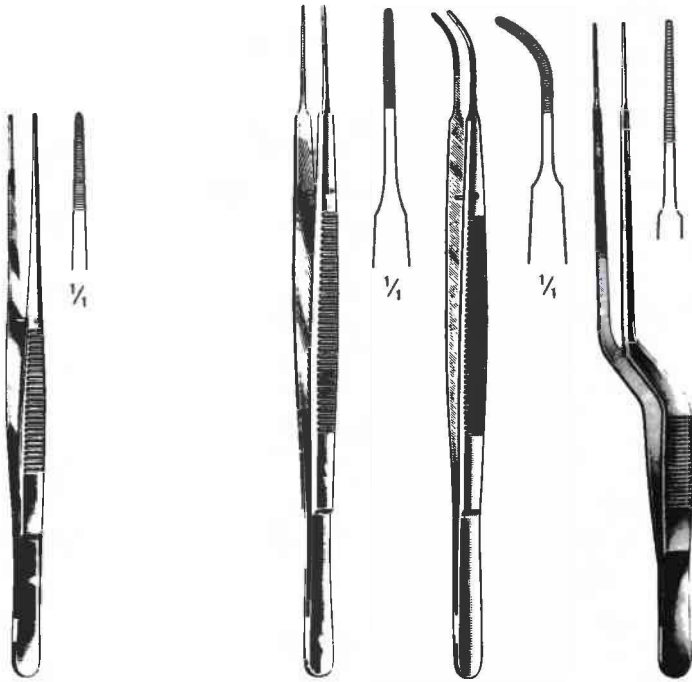

cm	SEMKEN	GERALD	GERALD	GERALD
12,5	H110-26012			
15,5	H110-26015			
18,0		H110-30218	H110-30318	H110-30518

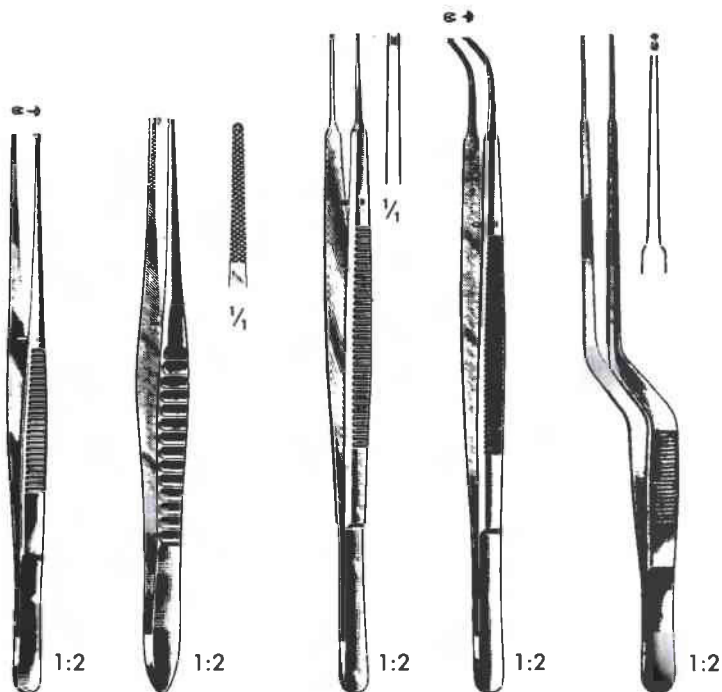

cm	SEMKEN	GILLIES	GERALD	GERALD	GERALD
12,5	H110-27012				
15,5	H110-27015	H110-27215			
18,0			H110-31018	H110-31118	H110-31318
23,0					

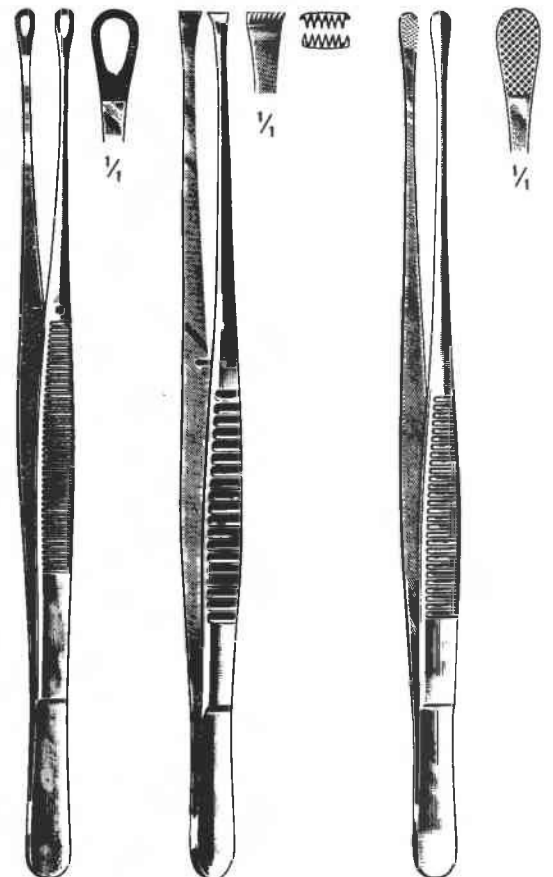

cm	SINGLEY	NELSON	WANGENSTEEN
12,5			
15,5			
18,0			
23,0	H110-32023	H110-32223	H110-32423



Splitterpinzetten, -zangen  
Splinter Forceps  
Pincès à échardes  
Pinzas para espinas  
Pinze per schegge

10

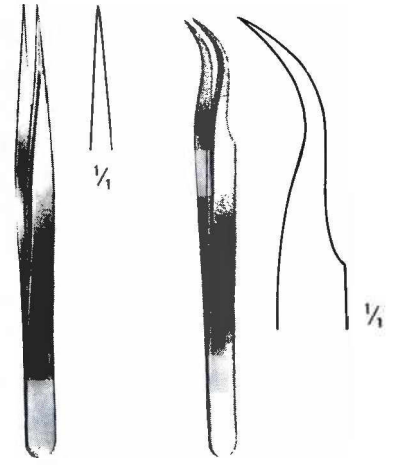

H110-33012  
12 cm

H110-33112  
12 cm

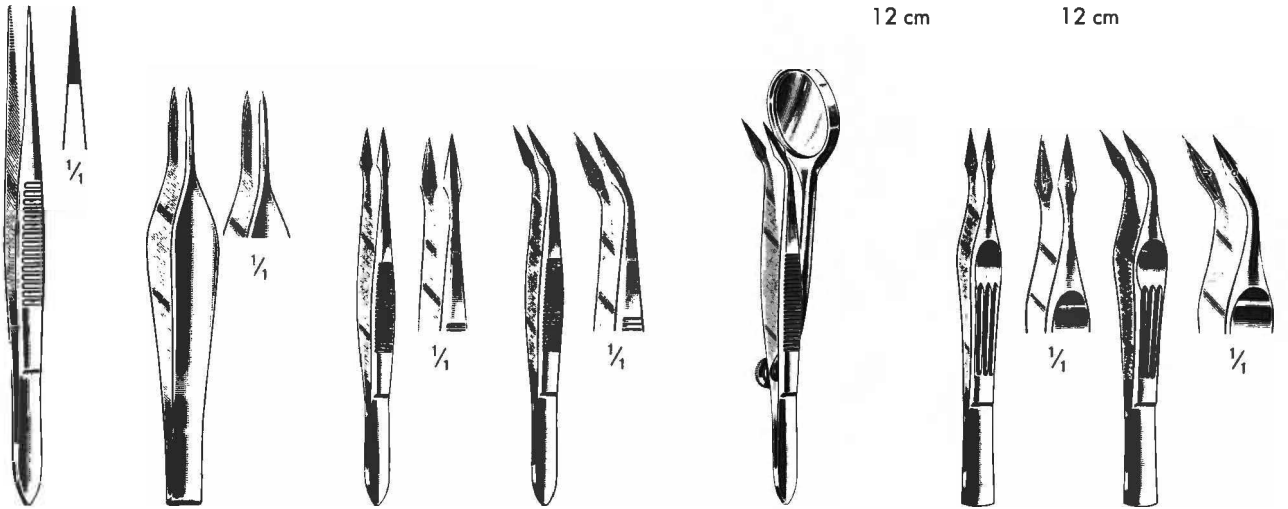

cm		FEILCHENFELD	HUNTER	HUNTER		CARMALT	CARMALT
7,5		H110-81007					
9,0	H110-80209						
10,5			H110-81210	H110-81310		H110-81610	H110-81710
11,5	H110-80211	H110-81011					
12,5					H110-81512		

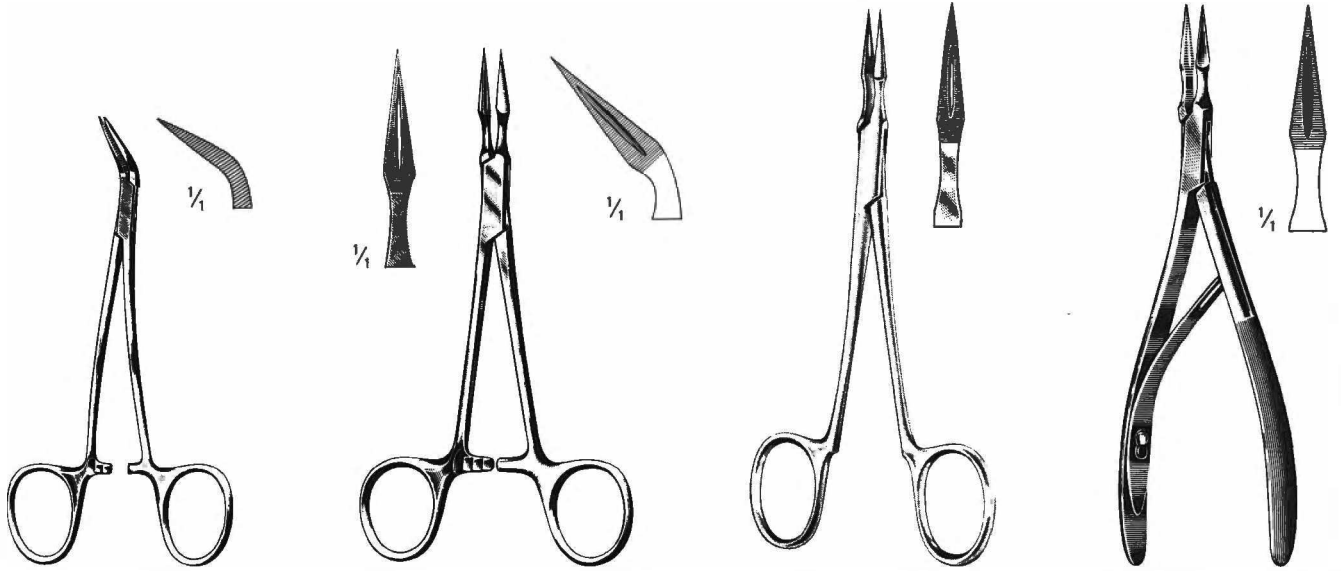

PEET  
H110-82111  
11,5 cm

STIEGLITZ  
H110-82213 H110-82313  
13,5 cm

ARCHER  
H110-82414 H110-82514  
14 cm

VIRTUS (RALK)  
H110-82815  
15 cm



H111-10212 H111-10312  
12 cm



H111-10415 H111-10515  
15 cm



H111-10818 H111-10918  
18 cm

Atraumatische Pinzetten  
Atraumatic Tissue Forceps  
Pincés atraumáticas  
Pinzas atraumáticas  
Pinze atraumatiche

11

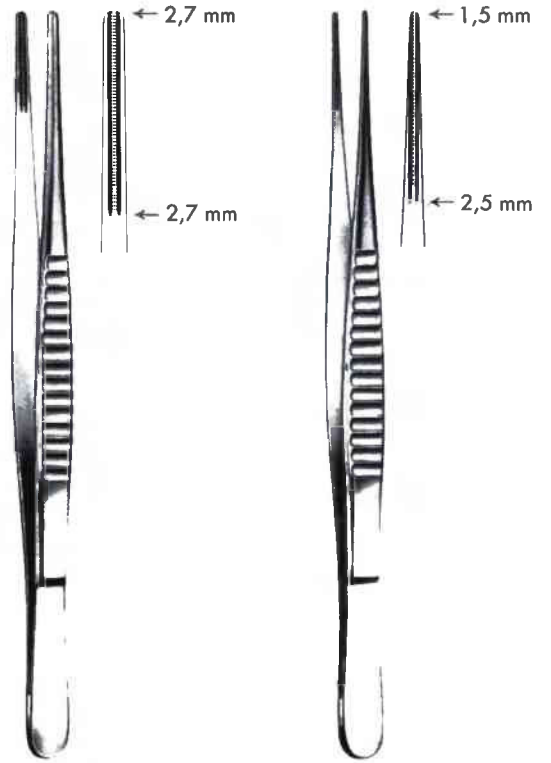

cm	DE BAKEY	DE BAKEY
16	H111-30416	H111-30616
20	H111-30420	H111-30620
24	H111-30424	H111-30624
30	H111-30430	

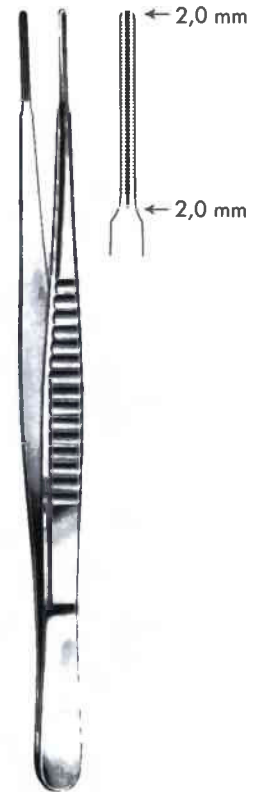
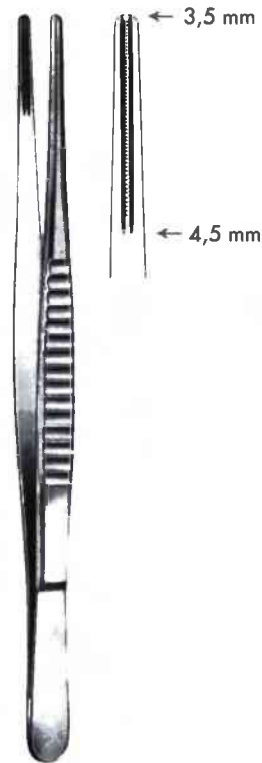
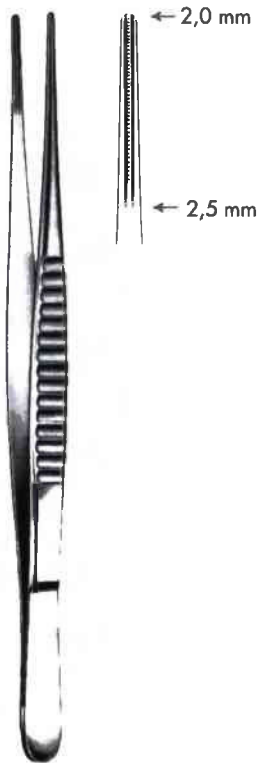

cm	DE BAKEY	DE BAKEY	DE BAKEY	COOLEY
16	H111-30816	H111-30916	H111-31016	H111-31416
20	H111-30820	H111-30920	H111-31020	H111-31420
24	H111-30824	H111-30924	H111-31024	
30	H111-30830	H111-30930	H111-31030	

Atrauma-Bulldogklemmen  
Atrauma Bulldog Clamps  
Clamos Bulldoa Atrauma

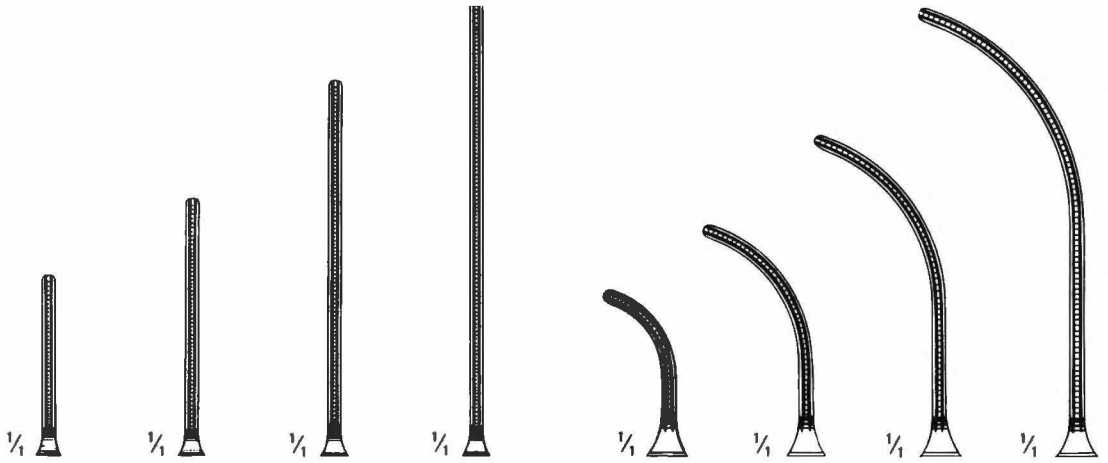

12

DE BAKEY  
H112-09207 - H112-09312

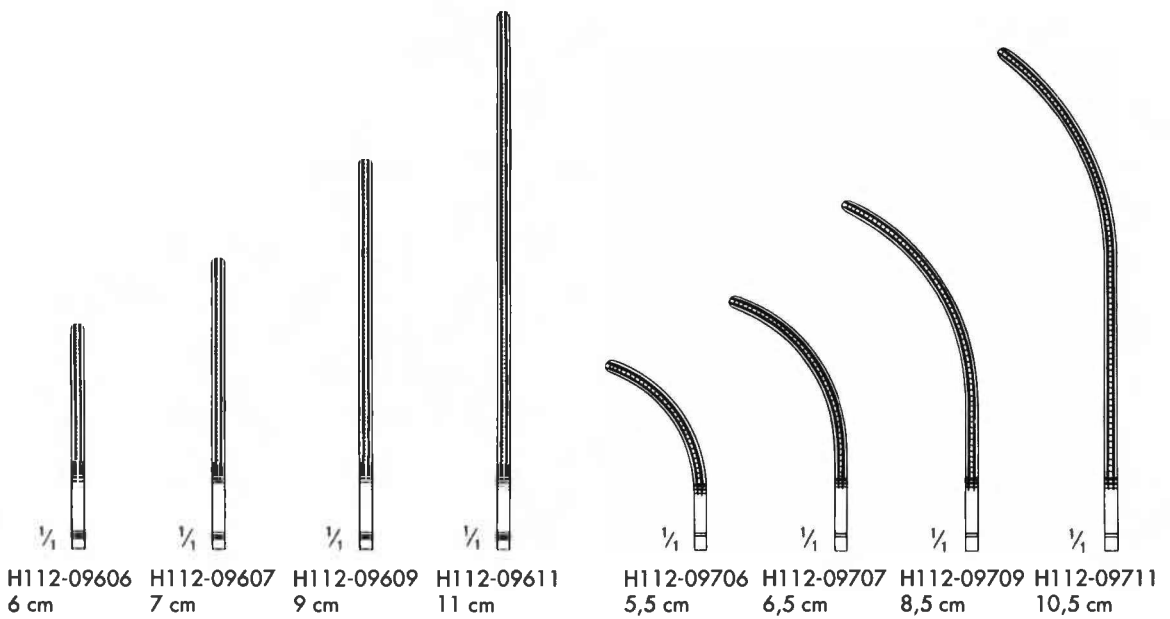
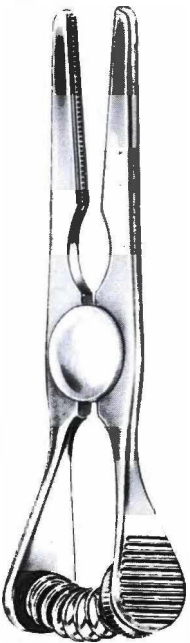

GLOVER  
H112-09606 - H112-09711

Arterienklemmen  
Hemostatic Forceps  
Pinces hémostatiques  
Pinzas hemostáticas  
Pinze emostatiche

12

Gefäßklemmen  
Serrefines  
Serre-fines  
Serra-finas  
Serrefine



cm	DIEFFENBACH		JOHNS-HOPKINS	
3,5	H112-10204	H112-10304		
5,0			H112-11050	H112-11150
5,5	H112-10205	H112-10305	H112-11055	H112-11155
6,5			H112-11065	H112-11165
7,0			H112-11070	H112-11170
7,5			H112-11075	H112-11175
9,0			H112-11090	H112-11190

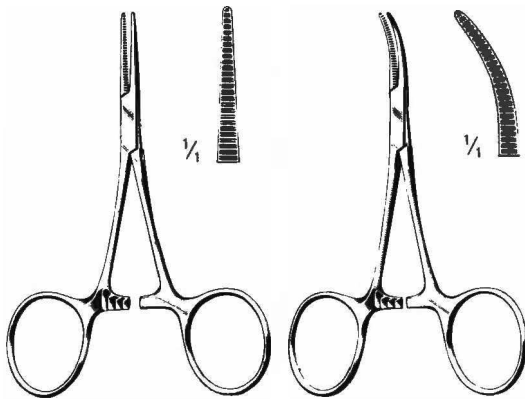

H112-21010      HARTMANN      10 cm      H112-21110

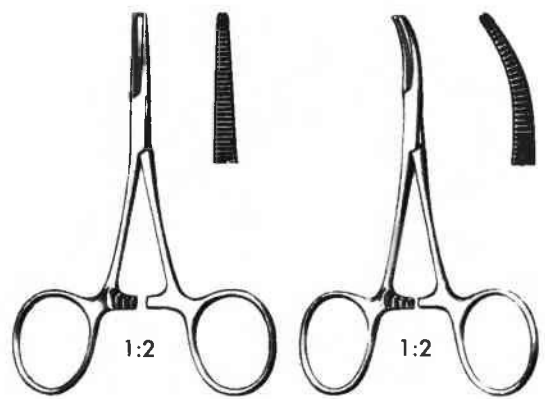

H112-21210      HARTMANN      10 cm      H112-21310



Titan  
Titanium  
Titane  
Titanio

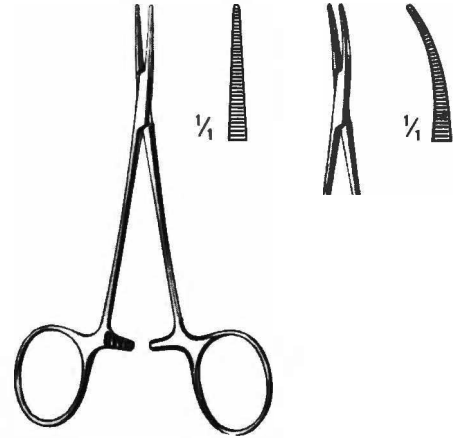
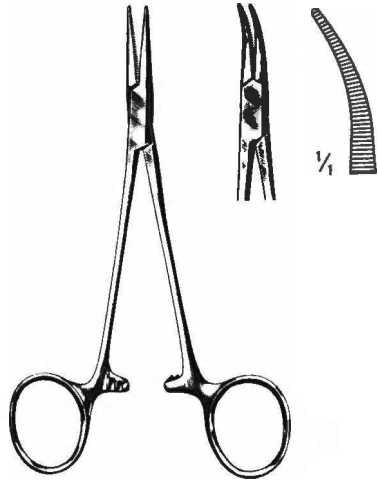

cm	HALSTED-MOSQUITO			HALSTED-MOSQUITO micro	
12,5	H112-22412	H112-22012	H112-22112	H12-22512	H112-22212
14,0		H112-22014	H112-22114		H112-22312
18,0		H112-22018	H112-22118		
21,0		H112-22021	H112-22121		

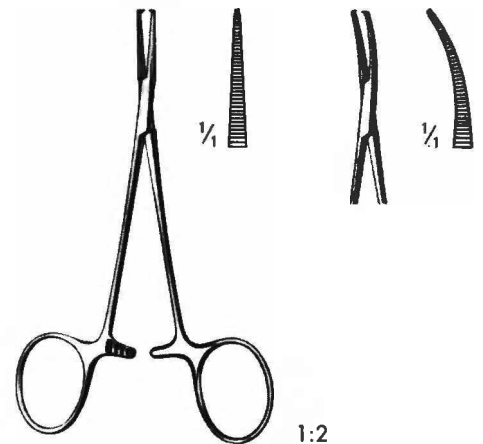
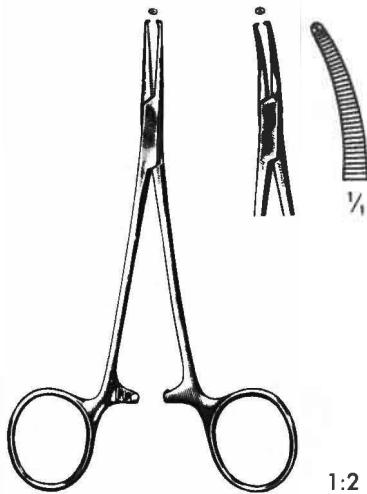

cm	HALSTED-MOSQUITO			HALSTED-MOSQUITO micro	
12,5	H112-23412	H112-23012	H112-23112	H112-23512	H112-23212
14,0		H112-23014	H112-23114		H112-23312
18,0		H112-23018	H112-23118		
21,0		H112-23021	H112-23121		

Arterienklemmen  
Hemostatic Forceps  
Pincés hémostatiques  
Pinzas hemostáticas  
Pinze emostatiche

12

Titan  
Titanium  
Titane  
Titanio

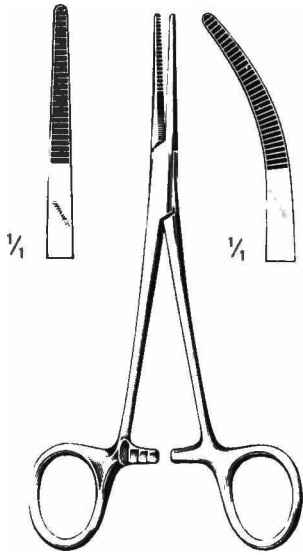

cm — KELLY —  
14 H112-24014 H112-24114  
14 H112-24414 H112-24514  
16

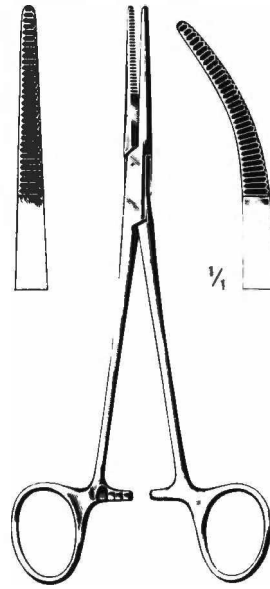

— KELLY-RANKIN —  
H112-24216 H112-24316

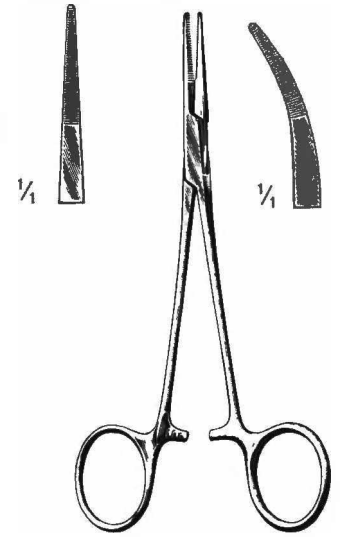

— PROVIDENCE-HOSPITAL —  
H112-27014 H112-27114

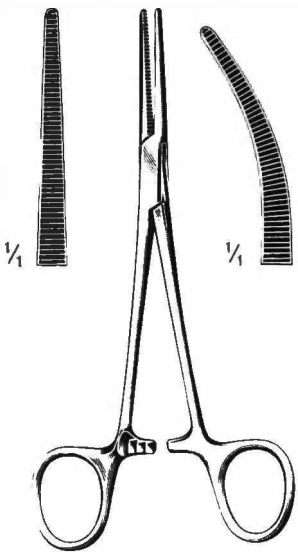

cm — CRILE —  
14 H112-25014 H112-25114 H112-26014 H112-26114  
14 H112-25414 H112-25514  
16

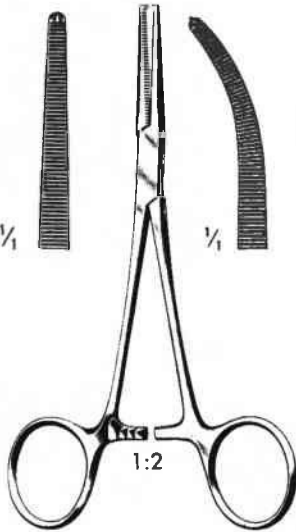

— CRILE —  
H112-26216 H112-26316

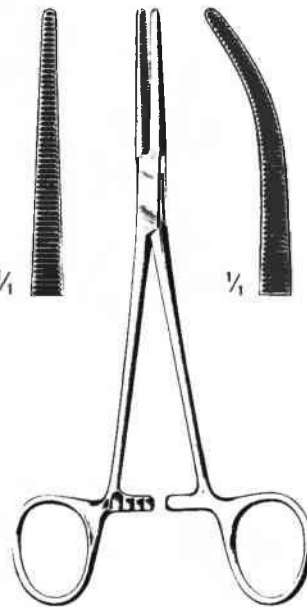

— CRILE-RANKIN —  
H112-26416 H112-26516



— CRILE-RANKIN —  
H112-26416 H112-26516

Arterienklemmen  
Hemostatic Forceps  
Pinces hémostatiques  
Pinzas hemostáticas  
Pinze emostatiche

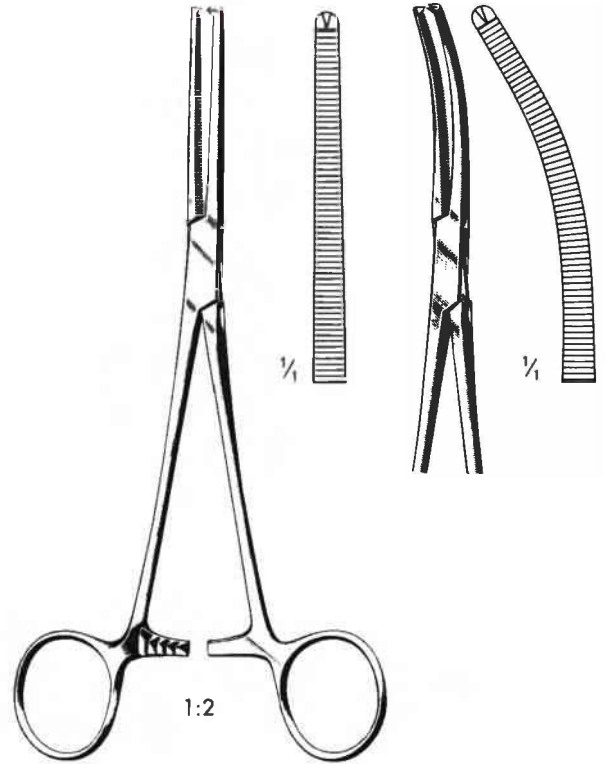
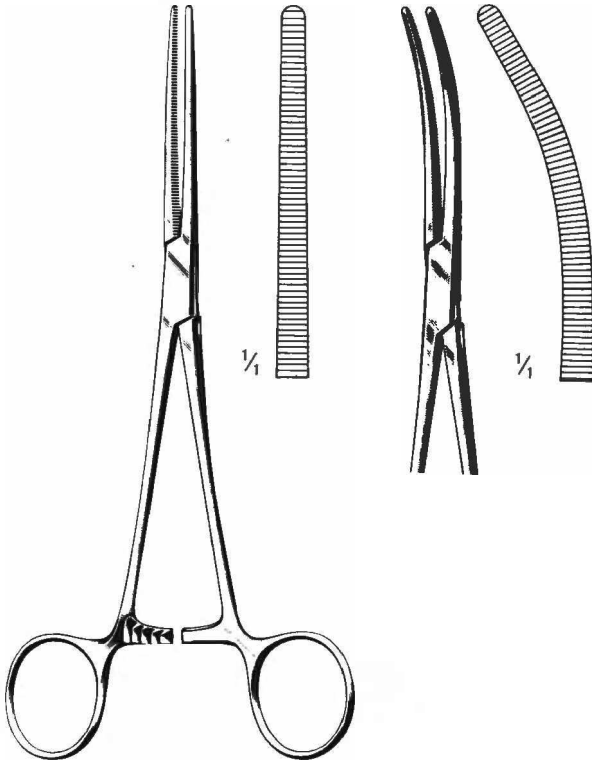

cm	ROCHESTER-PEAN		ROCHESTER-OCHSNER	
13	H112-31013	H112-31113	H112-32013	H112-32113
14	H112-31014	H112-31114	H112-32014	H112-32114
16	H112-31016	H112-31116	H112-32016	H112-32116
18	H112-31018	H112-31118	H112-32018	H112-32118
20	H112-31020	H112-31120	H112-32020	H112-32120
22	H112-31022	H112-31122	H112-32022	H112-32122
24	H112-31024	H112-31124	H112-32024	H112-32124
26	H112-31026	H112-31126	H112-32026	H112-32126
30	H112-31030	H112-31130	H112-32030	H112-32130

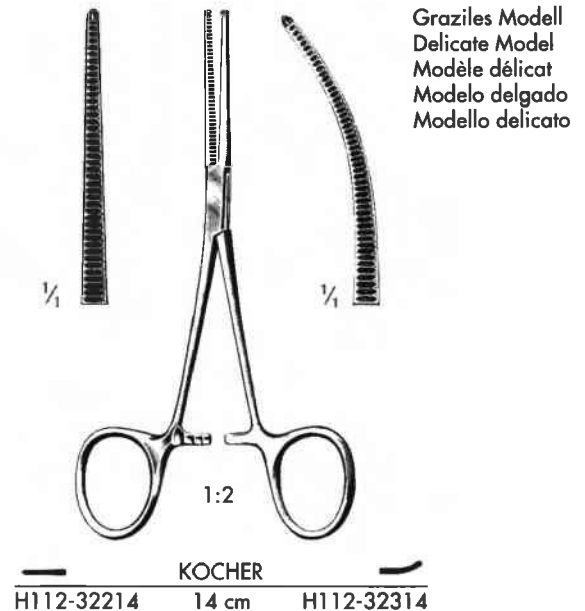
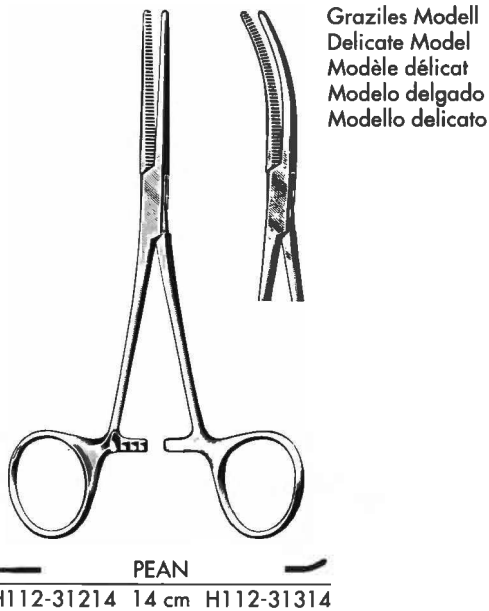

Arterienklemmen  
Hemostatic Forceps  
Pincès hémostatiques  
Pinzas hemostáticas  
Pinze emostatiche

12

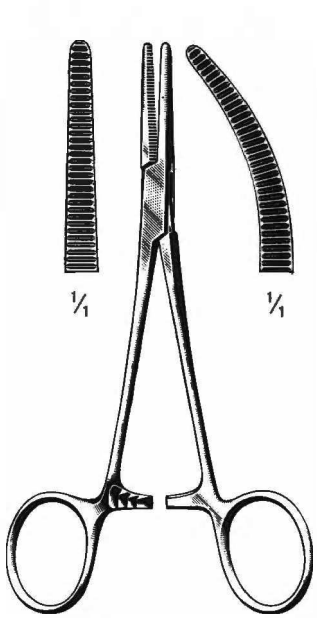

SPENCER-WELLS

H112-33013	13 cm	H112-33113
H112-33015	15 cm	H112-33115
H112-33018	18 cm	H112-33118
H112-33020	20 cm	H112-33120

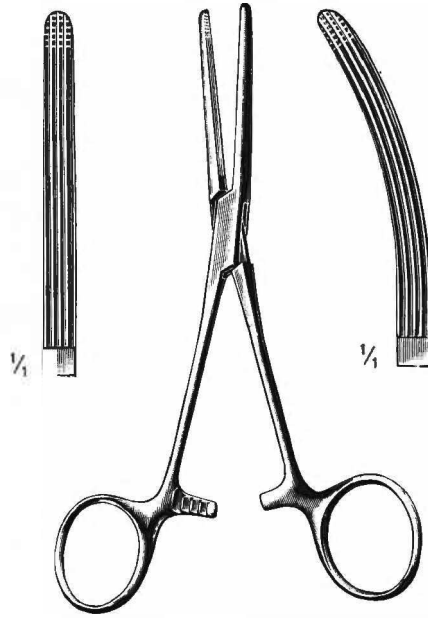

ROCHESTER-CARMALT

H112-34016	16 cm	H112-34116
H112-34020	20 cm	H112-34120

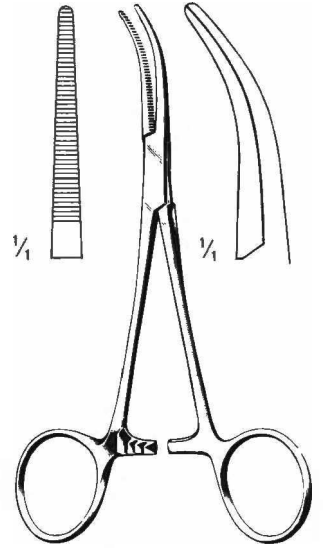

DANDY

H112-34514	14 cm
------------	-------

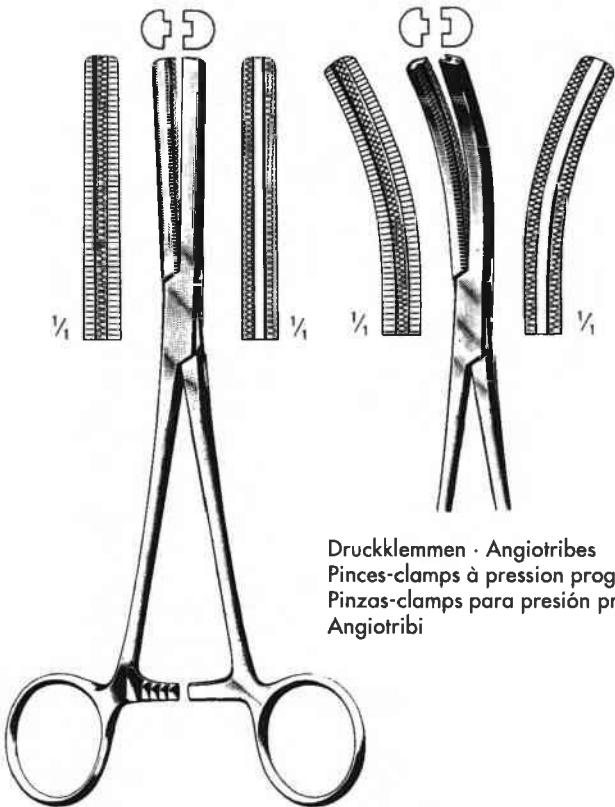

FERGUSSON

H112-35016	16 cm	H112-35116
H112-35020	20 cm	H112-35120

Druckklemmen · Angiotribes  
Pincès-clamps à pression progressive  
Pinzas-clamps para presión progresiva  
Angiotribi

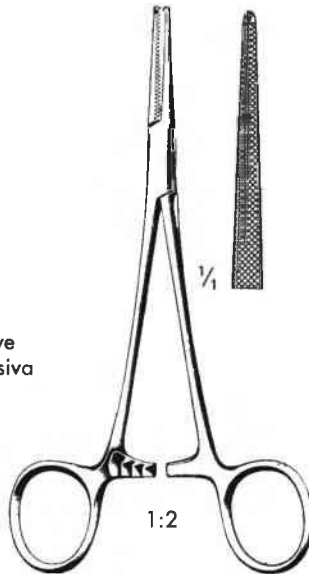

LOVELACE  
H112-35615  
15,5 cm

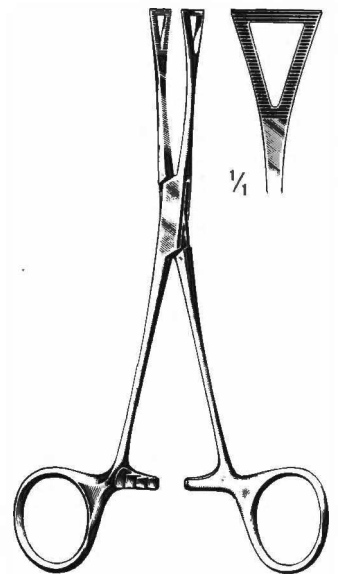

cm	PENNINGTON
15,5	H112-35815
20,0	H112-35820

Arterienklemmen  
Hemostatic Forceps  
Pincers hémostatiques  
Pinzas hemostáticas  
Pinze emostatiche

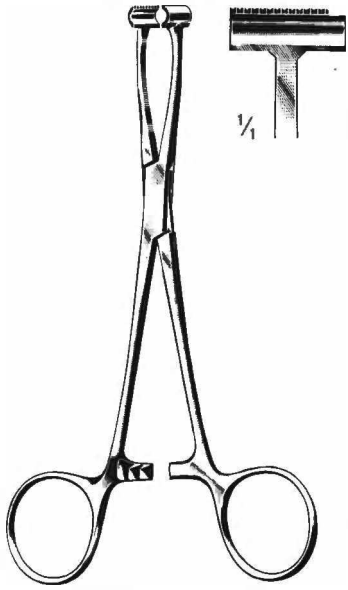

PRATT  
H112-36015  
15 cm

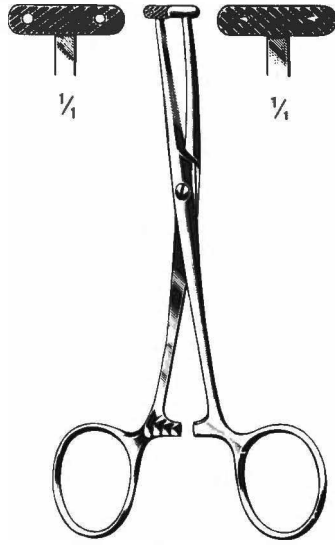

MARTEL  
H112-36414  
14 cm

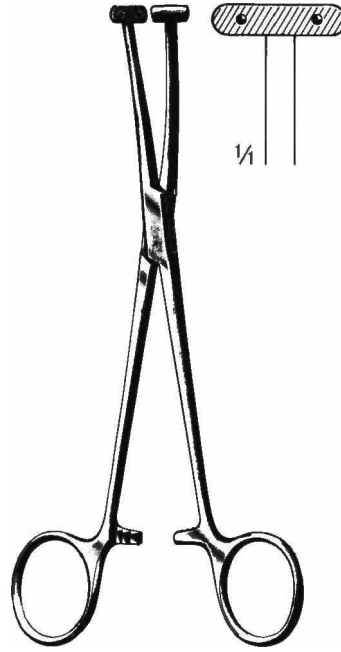

WILLET-MARTEL  
H112-36619  
19 cm

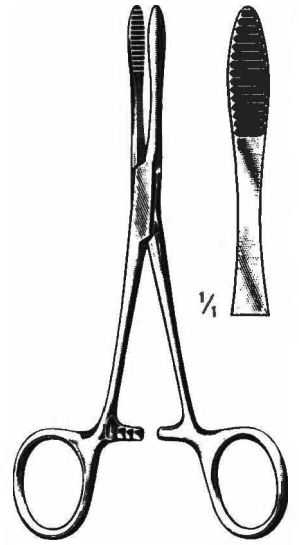

cm	PEAN
14	H112-36814
16	H112-36816

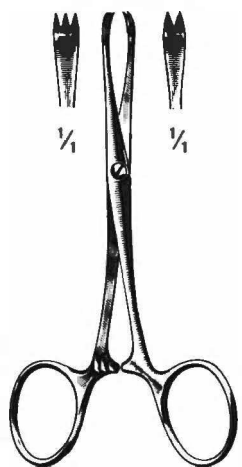

CHAPUT  
H112-37013  
13 cm

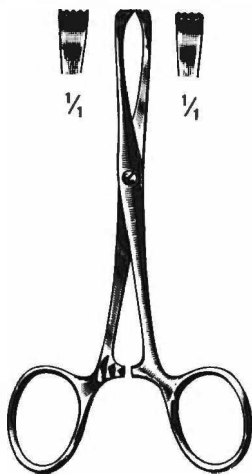

TUFFIER  
H112-37213  
13 cm

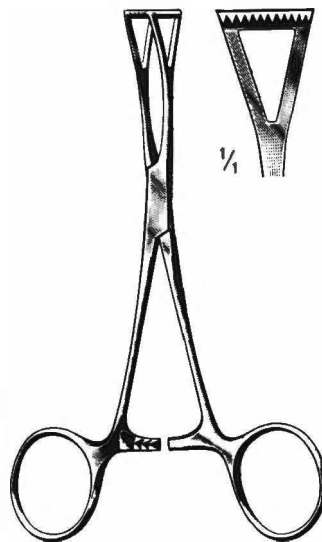

COLLIN  
H112-37414  
14 cm

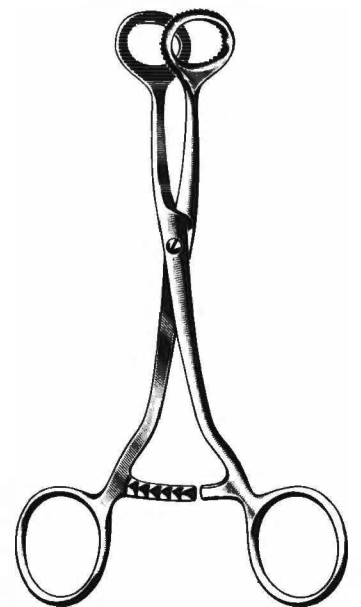

COLLIN  
H112-37616  
16 cm



Arterienklemmen  
Hemostatic Forceps  
Pincés hémostatiques  
Pinzas hemostáticas  
Pinze emostatiche

12

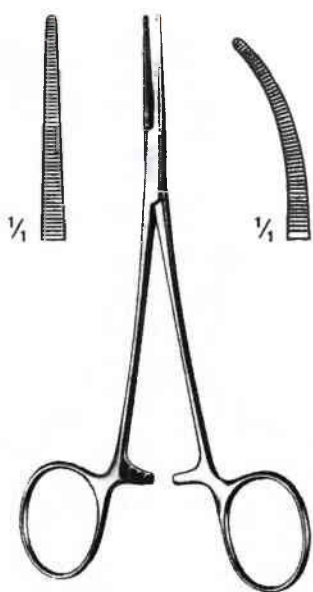

LERICHE

H112-38015 15 cm H112-38115

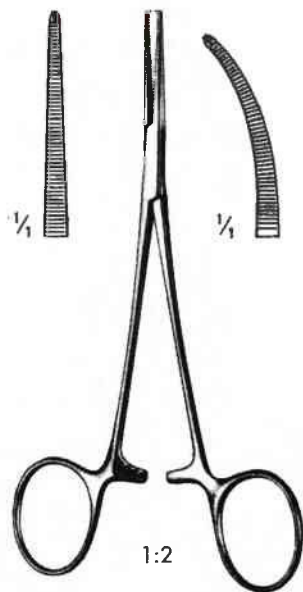

LERICHE

H112-38215 15 cm H112-38315

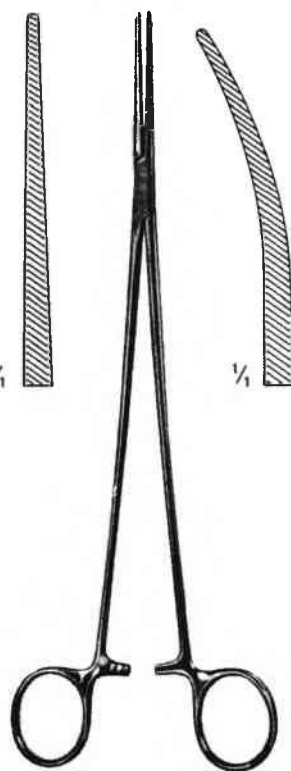

BENGOLEA

H112-38420 20 cm H112-38520  
H112-38426 26 cm H112-38526

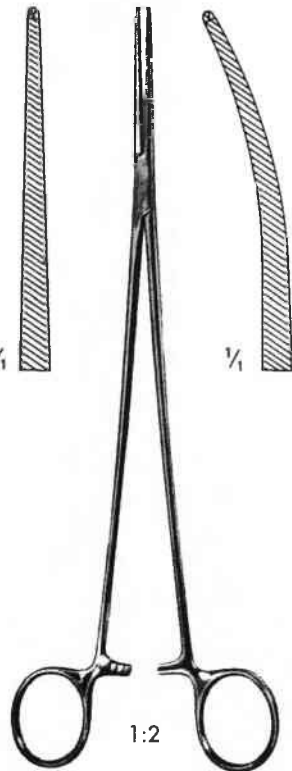

BENGOLEA

H112-38620 20 cm H112-38720  
H112-38626 26 cm H112-38726

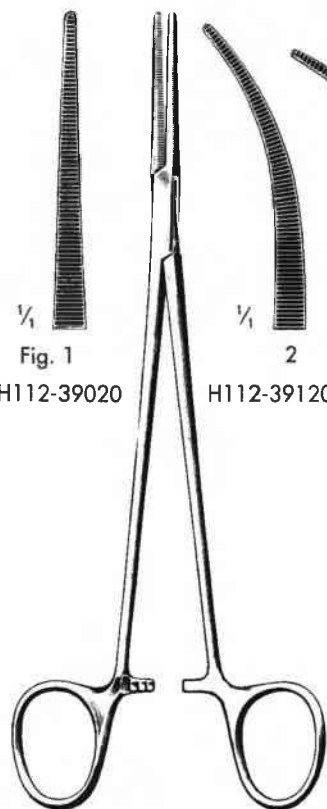

HEISS  
20 cm

Fig. 1  
H112-39020



2  
H112-39120

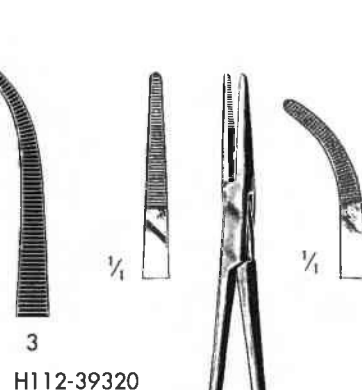

3  
H112-39320

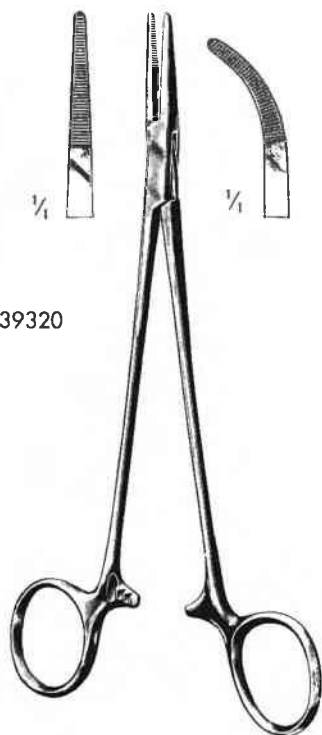

ADSON

H112-41018 18,5 cm H112-41118

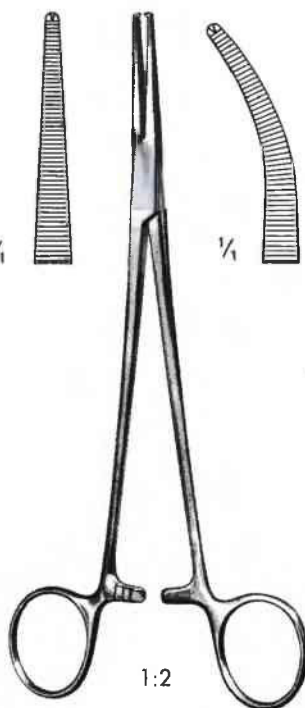

ADSON

H112-41218 18,5 cm H112-41318



ADSON Baby  
H112-41518

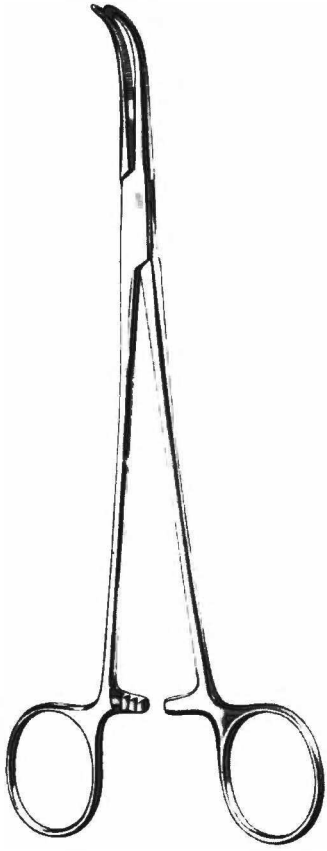

OVERHOLT-GEISSENDOERFER  
H112-42101 - H112-42708

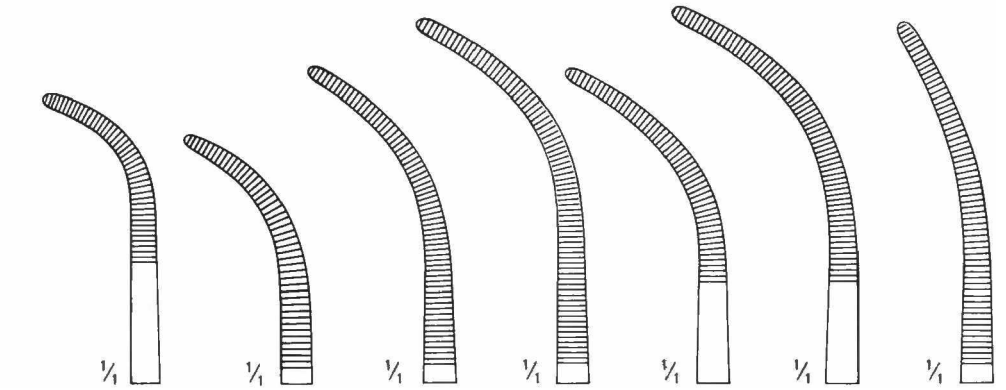

cm	Fig. 1	Fig. 2	Fig. 3	Fig. 4	Fig. 5	Fig. 6	Fig. 7
21	H112-42101	H112-42102	H112-42103	H112-42104	H112-42105	H112-42106	H112-42107
27	H112-42701	H112-42702	H112-42703	H112-42704	H112-42705	H112-42706	H112-42707

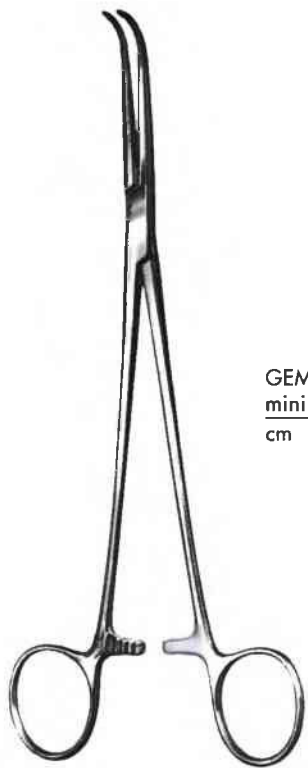

GEMINI  
GEMINI mini

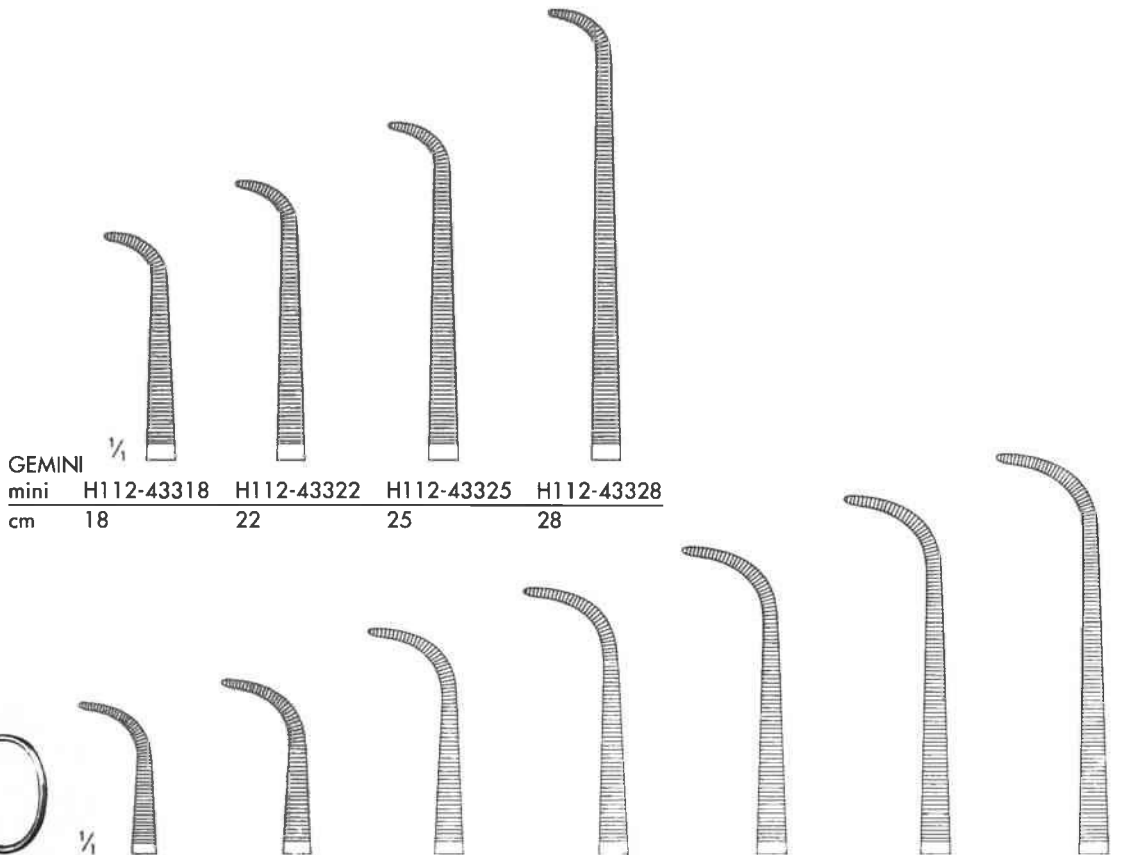

GEMINI mini	H112-43318	H112-43322	H112-43325	H112-43328
cm	18	22	25	28

GEMINI	H112-43113	H112-43116	H112-43118	H112-43120	H112-43123	H112-43125	H112-43128
cm	13	16	18	20	23	25	28

Arterienklemmen  
Hemostatic Forceps  
Pincés hémostatiques  
Pinzas hemostáticas  
Pinze emostatiche

12

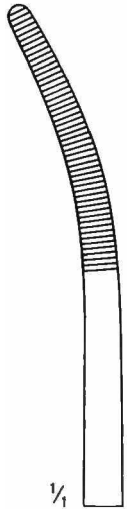

H112-44101

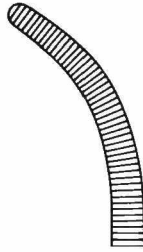

H112-44102

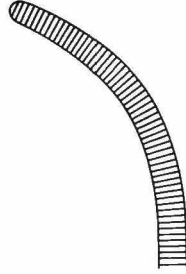

H112-44103

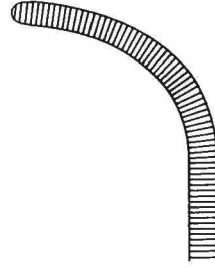

H112-44104

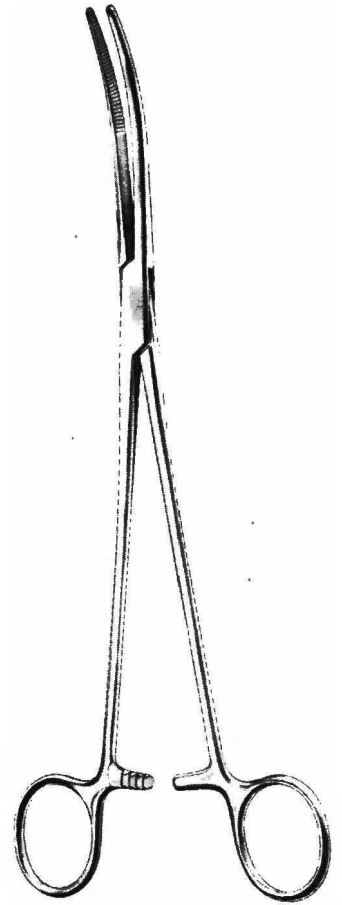

RUMEL  
H112-44101 - H112-44104  
23 cm



H112-44221 21 cm  
H112-44226 26 cm



H112-44321 21 cm  
H112-44326 26 cm



H112-44421 21 cm  
H112-44426 26 cm



H112-44521 21 cm  
H112-44526 26 cm

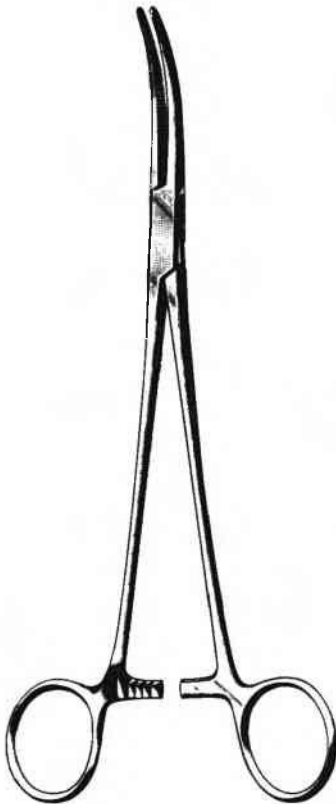

TOENNIS  
H112-44221 - H112-44526  
21 cm 26 cm

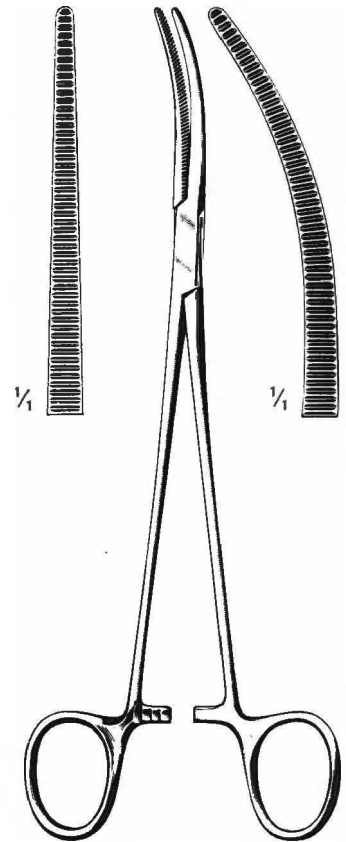

ROBERTS  
H112-44822 22 cm H112-44922

Bronchusklemmen  
Bronchus Forceps  
Pincès-Clamps à Bronches  
Pinzas clamps bronquiales  
Pinze per bronchi

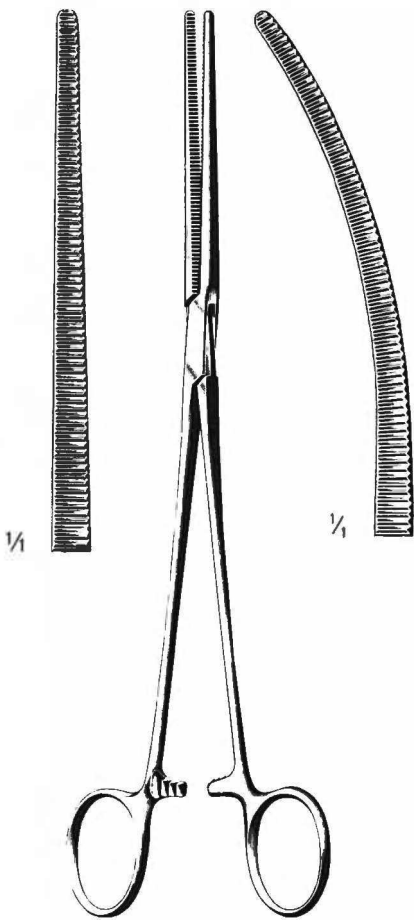

— SAROT —  
H112-45024 24 cm H112-45124

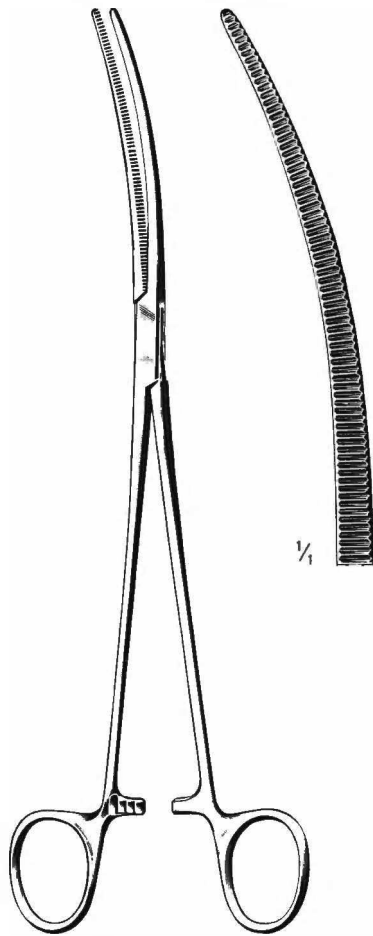

CRAFORD  
H112-45324  
24 cm

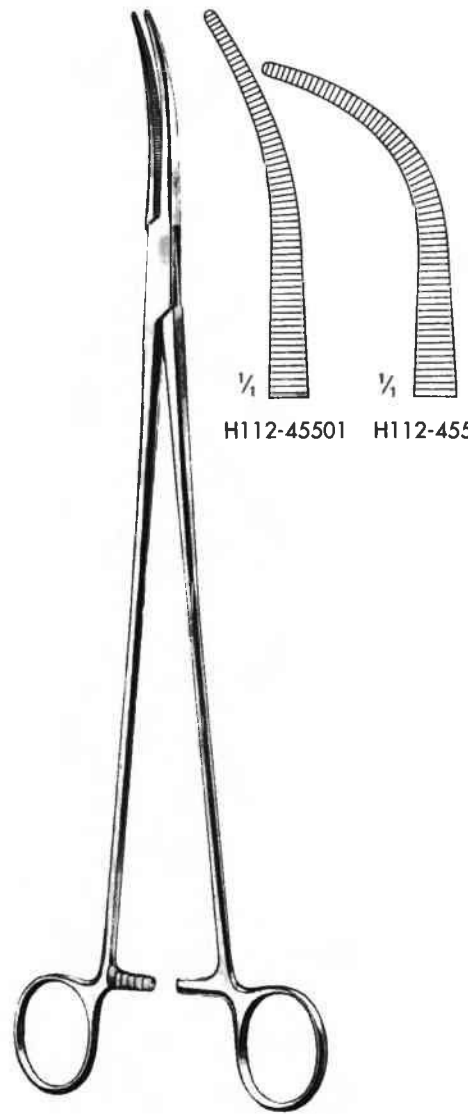

ZENKER  
H112-45501 - H112-45502  
29,5 cm

Arterienklemmen  
Hemostatic Forceps  
Pincés hémostatiques  
Pinzas hemostáticas  
Pinze emostatiche

12

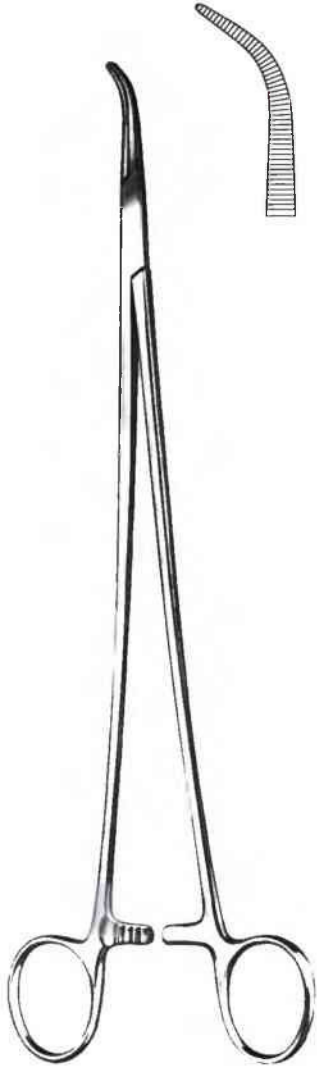

LAWRENCE  
H112-45728  
28 cm



MEEKER  
H112-45928  
28 cm

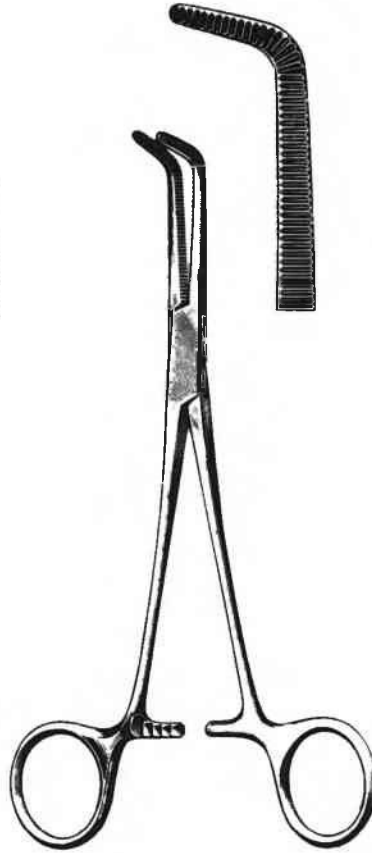

cm	MIXTER
14	H112-47114
16	H112-47116
18	H112-47118
23	H112-47123

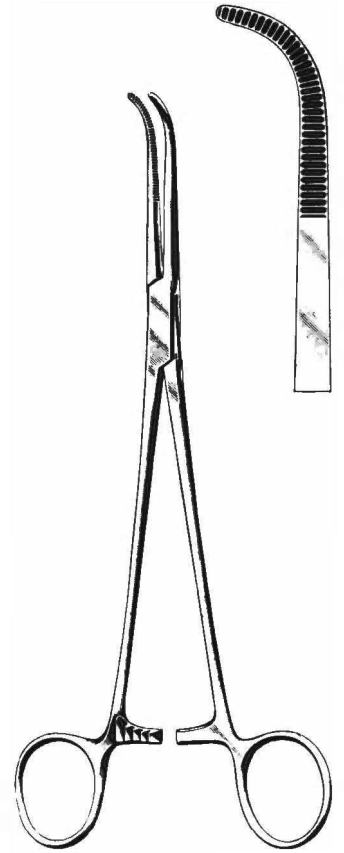

MIXTER  
H112-47322  
22 cm

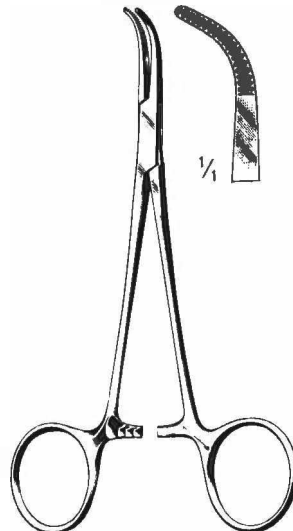

MIXTER Baby  
H112-47514  
14 cm



MIXTER Baby  
H112-47518  
18 cm



Arterien, Gallenkanal, Nierenstiel  
Hemostatic, Gall Duct and Kidney Pedicle  
Hémostatiques, pédicule rénal et voies biliaires  
Hemostáticas, pedículo renal y vías biliares  
Emostatiche, pedunculo renale e vie biliari

Arterienklemmen  
Hemostatic Forceps  
Pinces hémostatiques  
Pinzas hemostáticas  
Pinze emostatiche

112

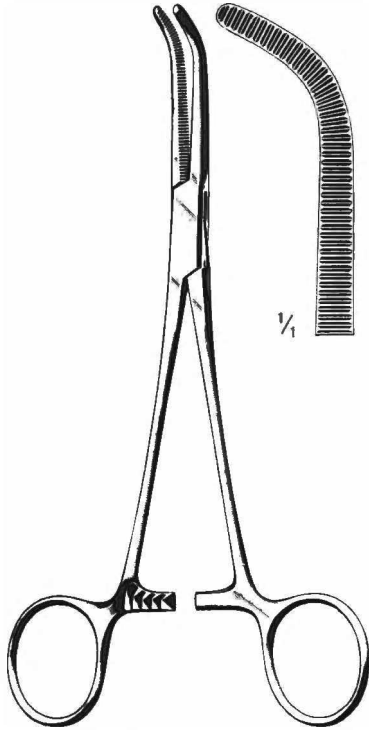

cm MIXTER-O'SHAUGNESSY  
15,5 H112-47715  
19,0 H112-47719

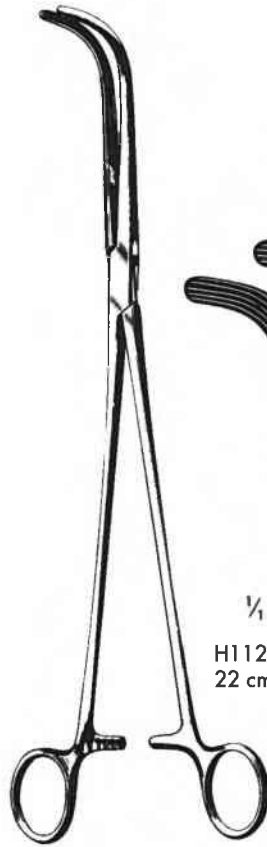

MIXTER  
H112-47922 - H112-47928

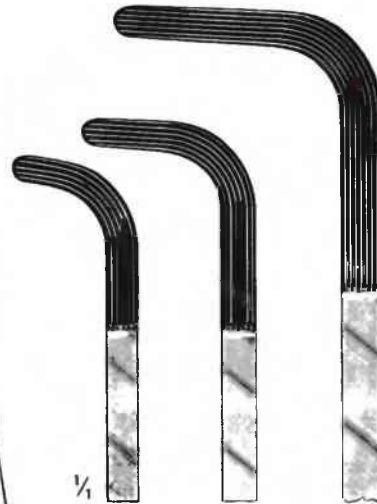

H112-47922 22 cm  
H112-47925 25 cm  
H112-47928 28 cm

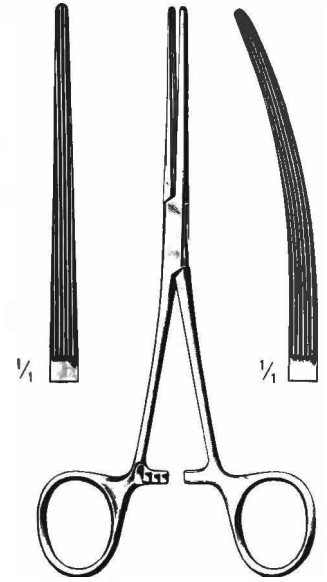

BAINBRIDGE  
H112-48015 15,0 cm H112-48115  
H112-48018 18,5 cm H112-48118

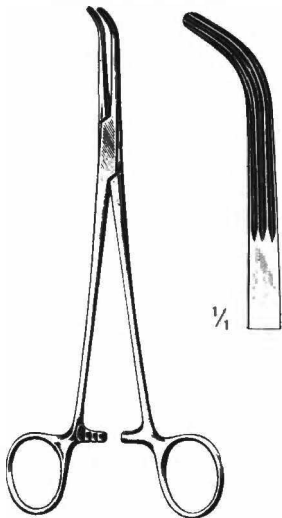

LAHEY  
H112-49119  
19 cm

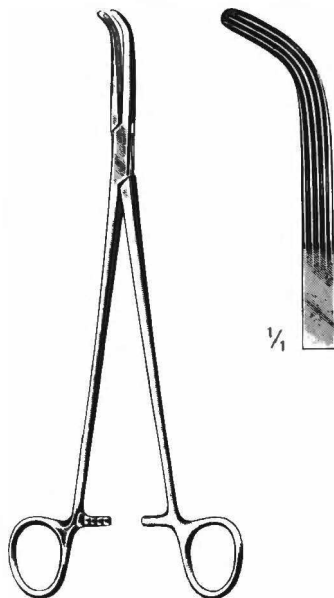

LAHEY  
H112-49323  
23 cm

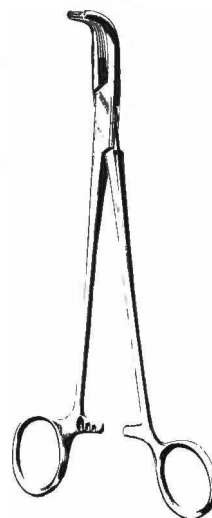

LOWER  
H112-49518  
18 cm

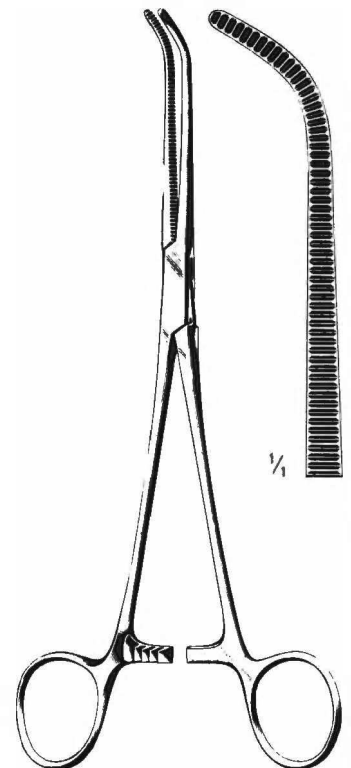

JOHNS-HOPKINS  
H112-49720  
20 cm

Arterienklemmen  
Hemostatic Forceps  
Pincés hémostatiques  
Pinzas hemostáticas  
Pinze emostatiche

Gallenkanal  
Gall Duct  
Voies biliaires  
Vias biliares  
Vie biliari

12

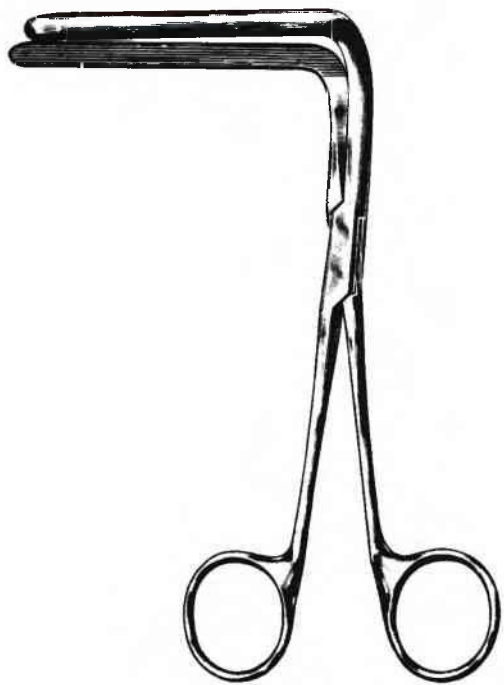

MIXTER  
H112-49916  
16,5 cm

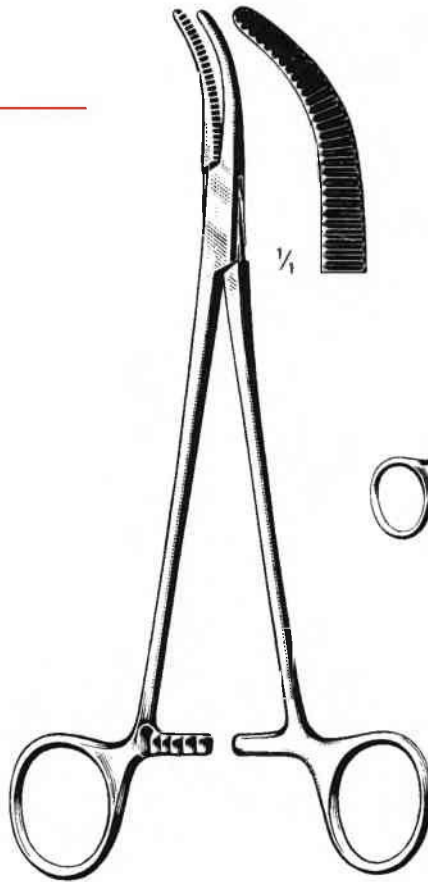

MOYNIHAN  
H112-50123  
23 cm

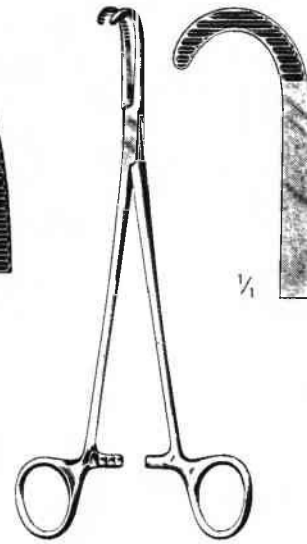

DESJARDINS  
H112-50321  
21 cm

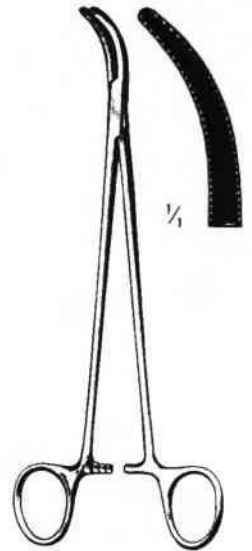

DESJARDINS  
H112-50521  
21 cm

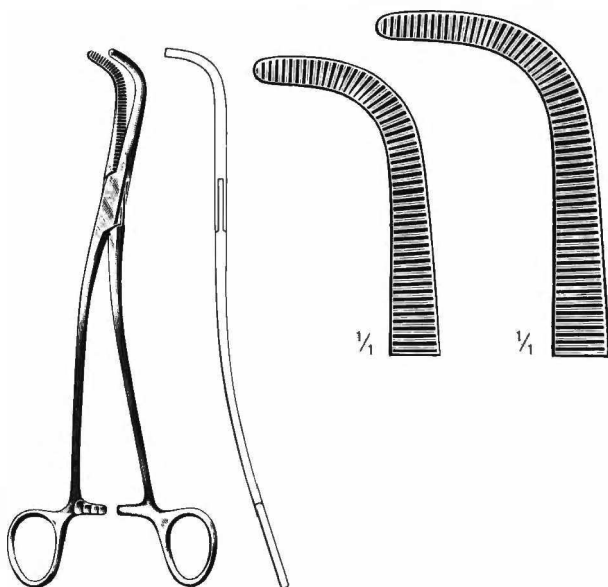

GRAY

H112-50722 22 cm    H112-50723 23 cm

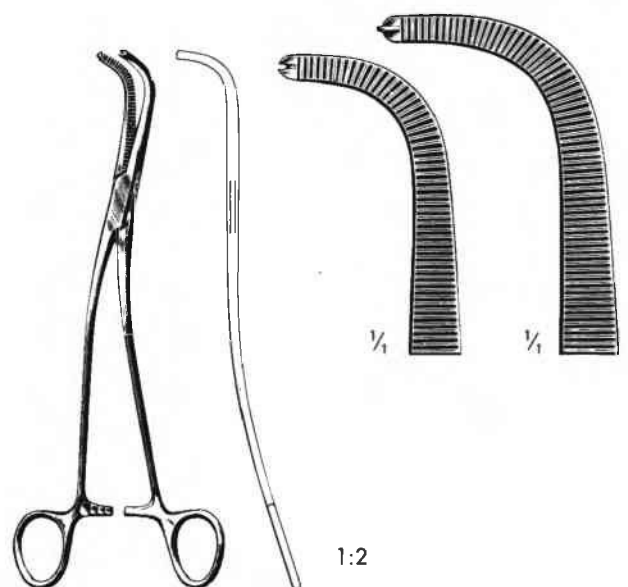

GRAY

1:2

H112-50922 22 cm    H112-50923 23 cm

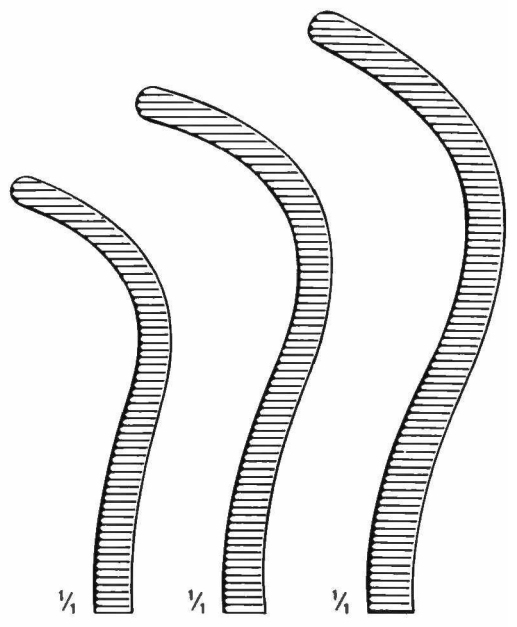
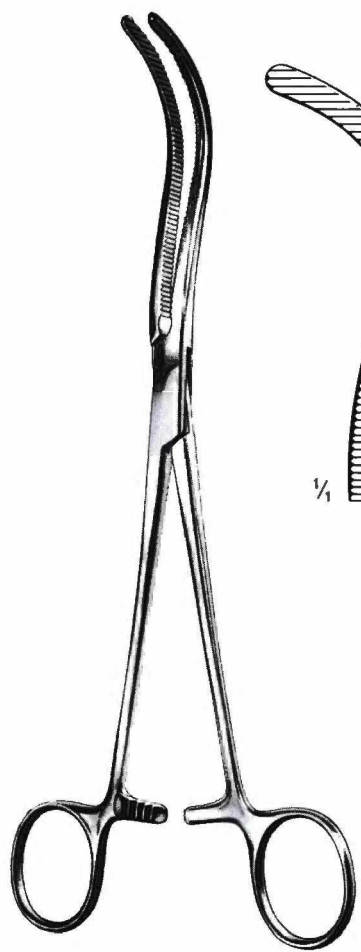
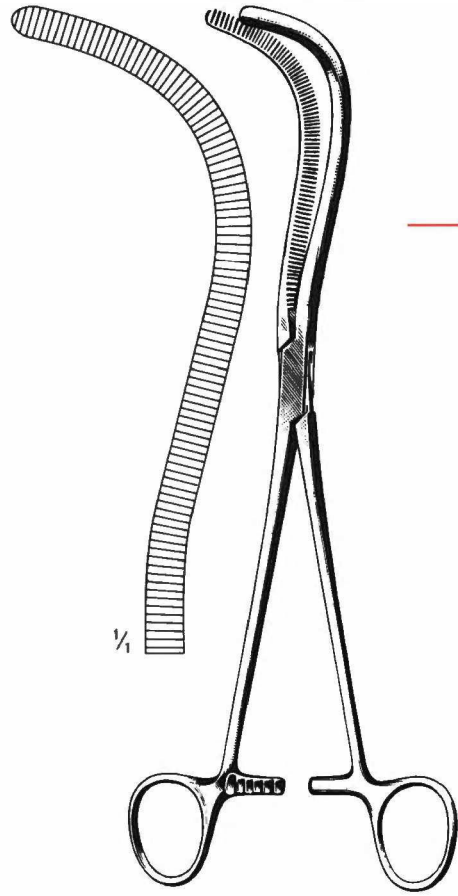
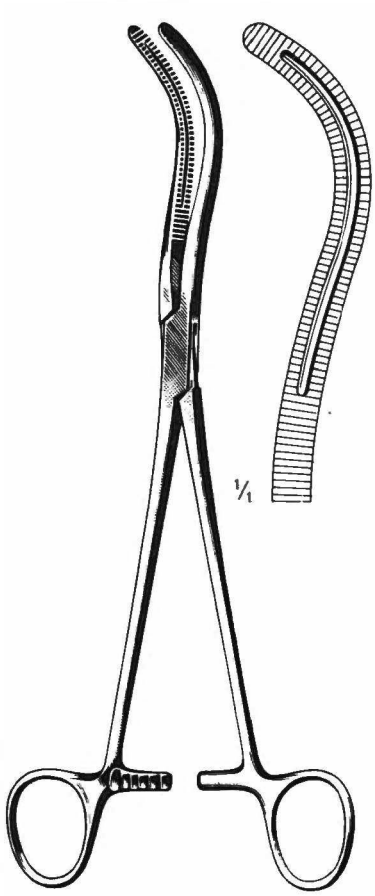

GUYON  
H112-51723  
23 cm

GUYON

H112-51920  
20 cm

H112-51922  
22 cm

H112-51924  
24 cm

Arterienklemmen  
Hemostatic Forceps  
Pincés hémostatiques  
Pinzas hemostáticas  
Pinze emostatiche

2

Nierenstiél  
Kidney Pedicle  
Pédicule rénal  
Pediculo renal  
Pedunculo renale

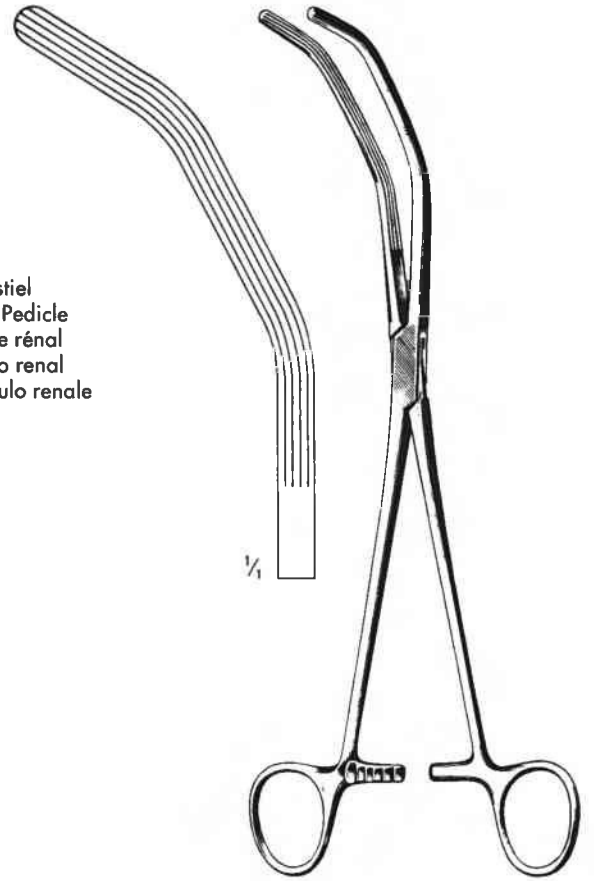

HERRICK  
H112-52323  
23 cm

Peritoneum-Klemmen  
Peritoneum Forceps  
Pincés à péritoine  
Pinzas para peritoneo  
Pinze peritoneali



MIKULICZ  
H112-55120  
20 cm

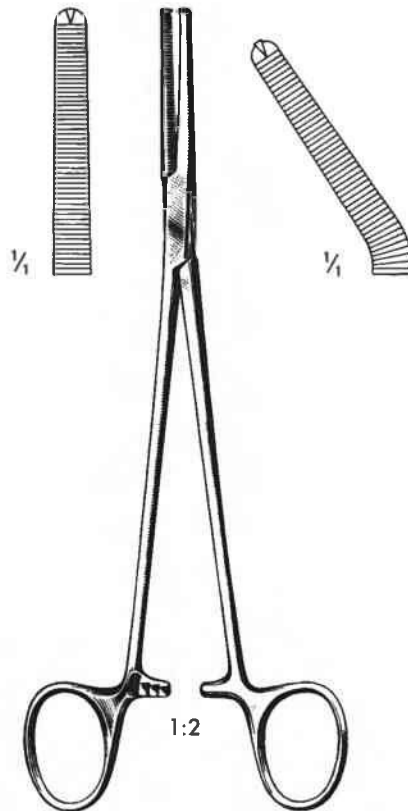

PHANEUF  
H112-55421 21 cm H112-55521

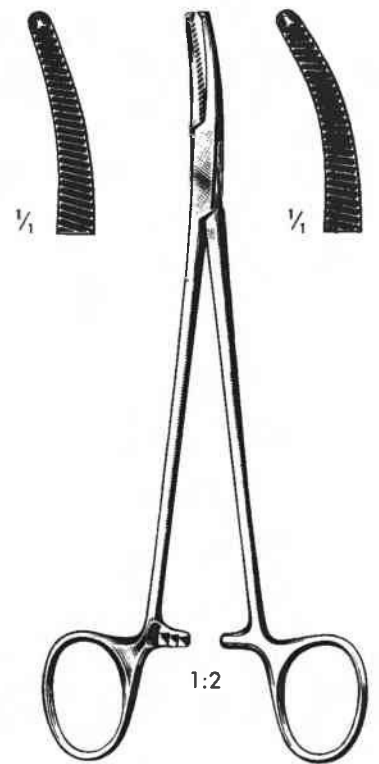

FAURE  
H112-56120 20 cm H112-56320

Hysterektomie-Klemmen  
Hysterectomy Forceps  
Pinces à hysterectomie  
Pinzas para hysterectomía  
Pinze per isterectomia

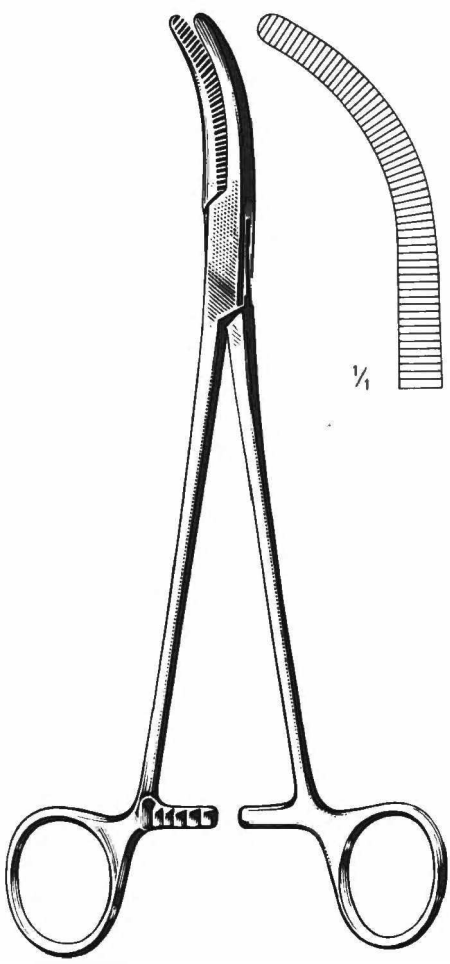

WERTHEIM  
H112-57125  
25 cm

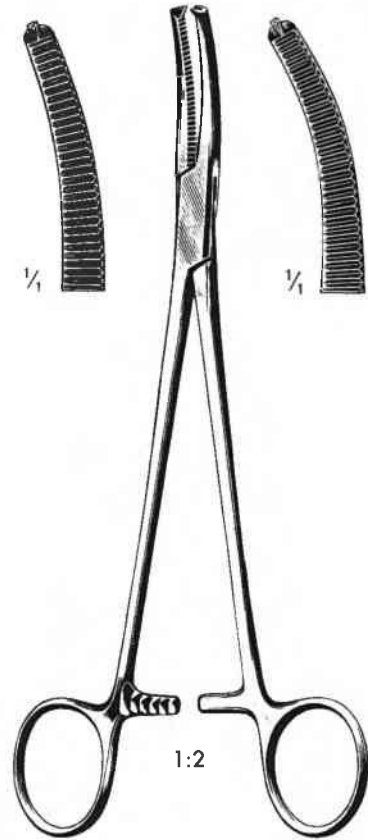

WERTHEIM  
H112-57322 22 cm      H112-57523 23 cm

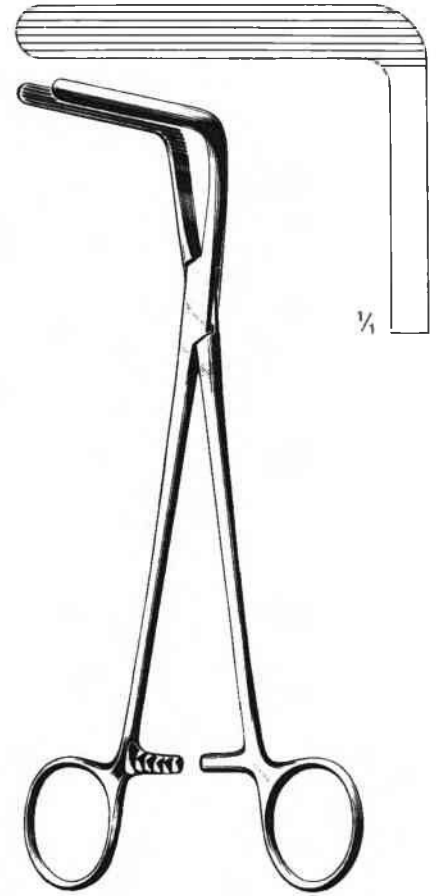

WERTHEIM-CULLEN  
H112-57921  
21,5 cm

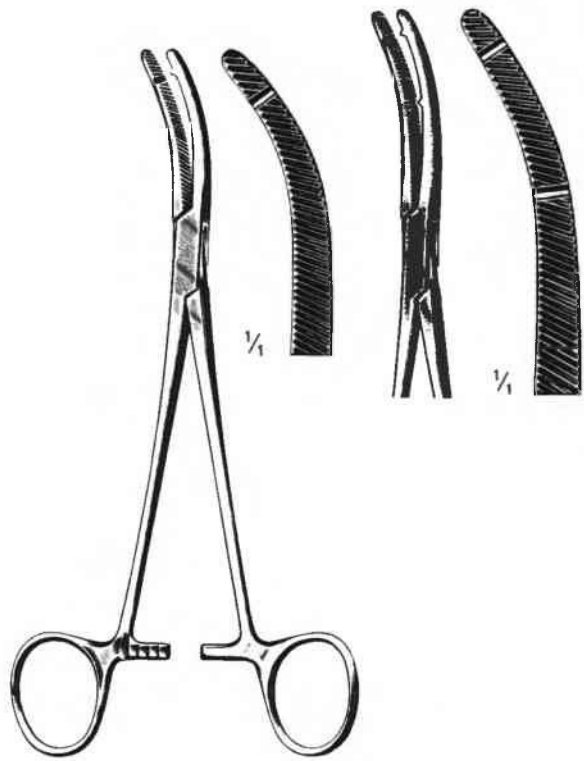

HEANEY  
20 cm      H112-59120      H112-59320



Schlauchklemmen  
Tubing Clamps  
Pincas serre-tubes  
Pinzas cierra-tubos  
Pinze serretubi

2

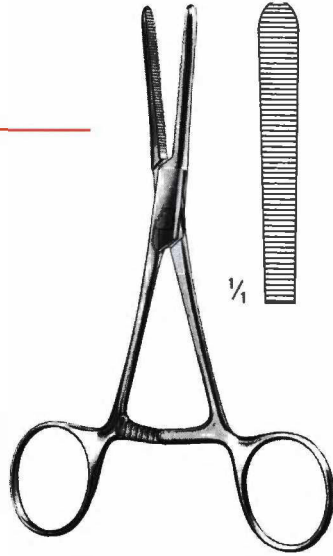

H112-70214  
14,5 cm

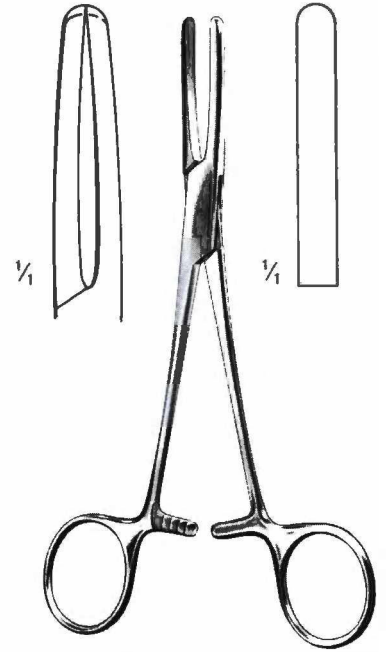

H112-70416 16 cm  
H112-70418 18 cm

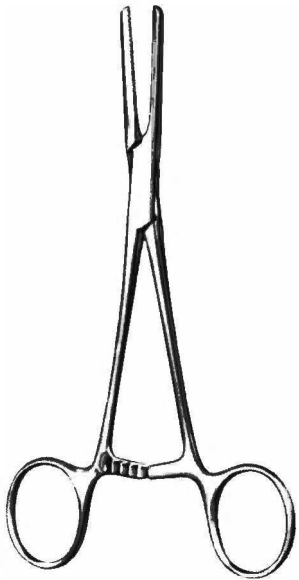

H112-71015 - H112-71020



H112-71015  
15 cm



H112-71018  
18 cm



H112-71020  
20 cm



H112-71215 - H112-71220



H112-71215  
15 cm



H112-71218  
18 cm



H112-71220  
20 cm

Tuchklemmen  
Towel Forceps  
Pincès à champs  
Pinzas para campos  
Pinze fissateli



SCHAEDEL  
H114-10109  
9 cm



JONES  
H114-10309  
9 cm

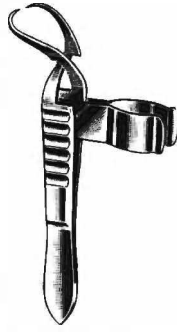

JONES-CLIP  
H114-10509  
9 cm

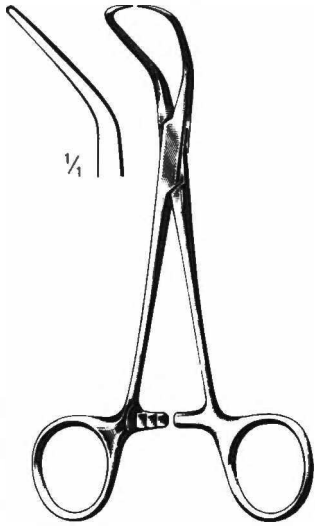

cm	BACKHAUS
9	H114-11109
11	H114-11111
13	H114-11113
15	H114-11115

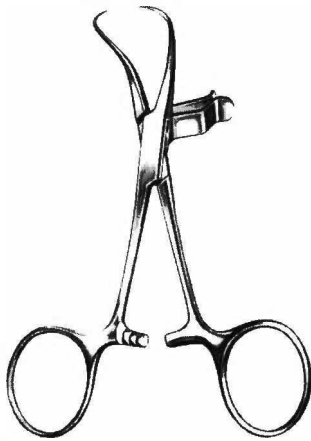

BACKHAUS-CLIP  
H114-11511  
11 cm

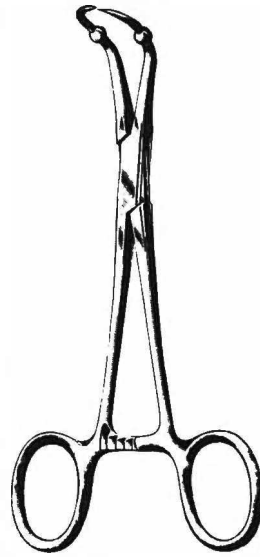

ROEDER  
H114-11713  
13 cm

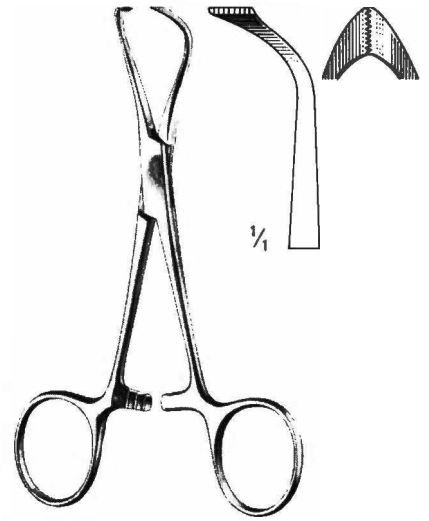

cm	LORNA
11	H114-12111
13	H114-12113

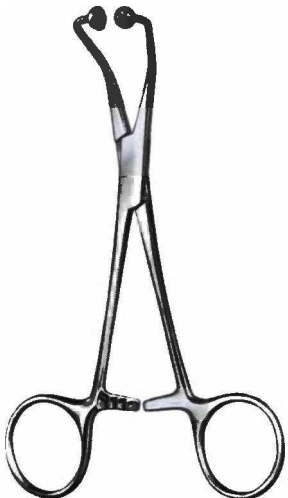

Ball and Socket  
H114-12313  
13 cm



BERNHARD  
H114-14016  
16,5 cm

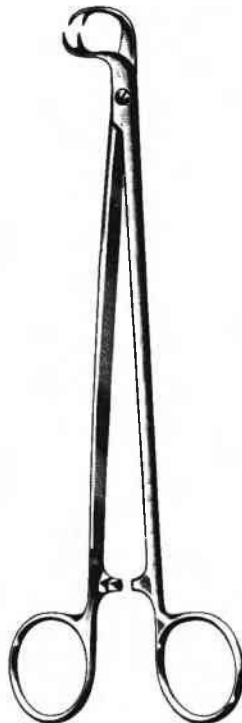

MOYNIHAN  
H114-15019  
19 cm



DOYEN  
H114-16118  
18 cm



LANE  
H114-16420  
20 cm

Tupferzangen  
Dressing Forceps  
Pincès à pansements  
Pinzas para taponés  
Pinze per medicatura

Korn- und Polypenzangen  
Dressing and Polypus  
à polypes et à pansements  
para pólipos  
per tamponi e polipi

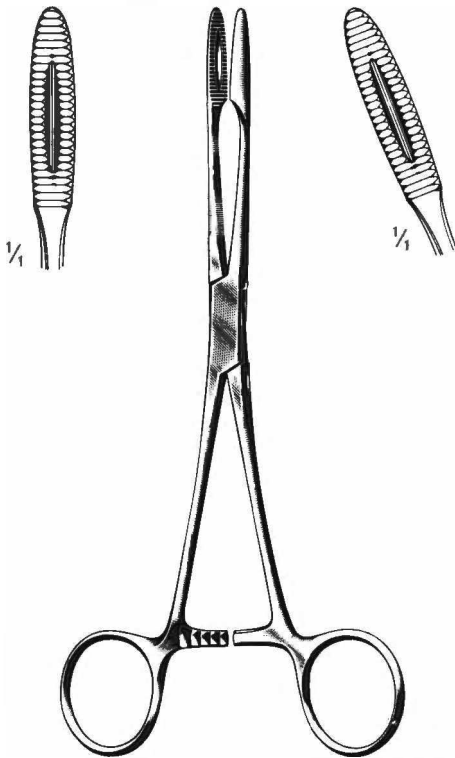

— GROSS-MAIER —		
H116-11020	20 cm	H116-11120
H116-11025	25 cm	H116-11125

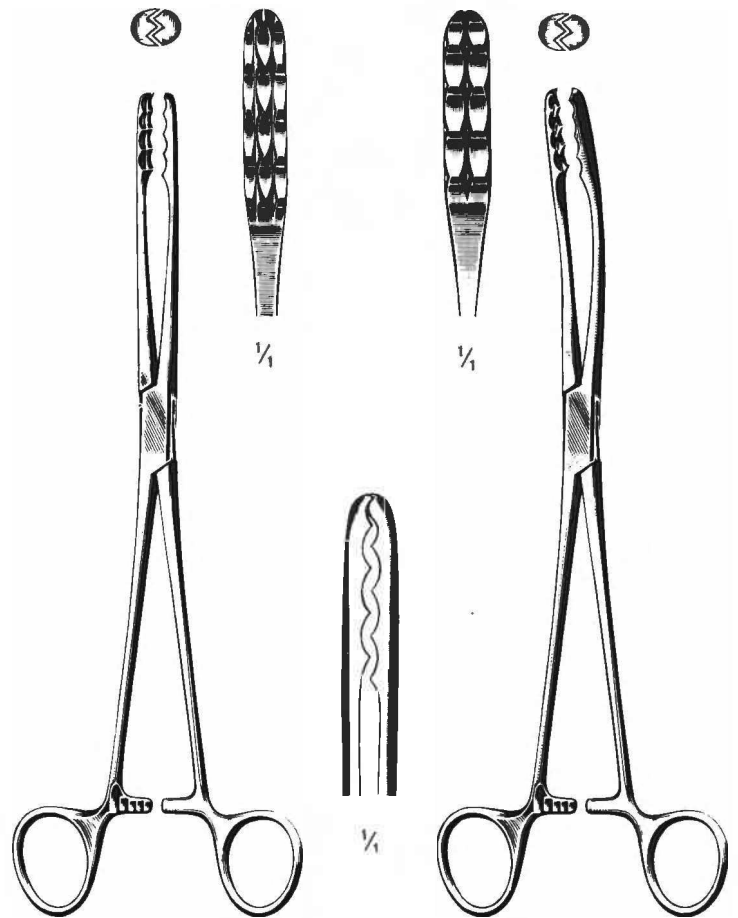

ULRICH		—	cm	ULRICH	
H116-16022	22			H116-16122	
H116-16025	25			H116-16125	

Schwammzangen  
Sponge Holding Forceps  
Pinces porte-éponges  
Pinzas porta esponjas  
Pinze per tamponi e spugne

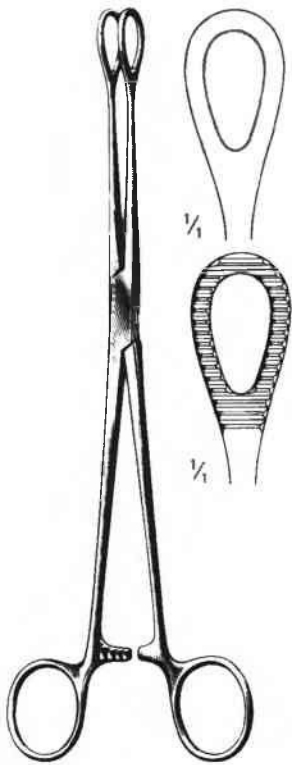

FOERSTER

cm

18	H116-17018	H116-17118	H116-17218	H116-17318
20	H116-17020	H116-17120		
25	H116-17025	H116-17125	H116-17225	H116-17325

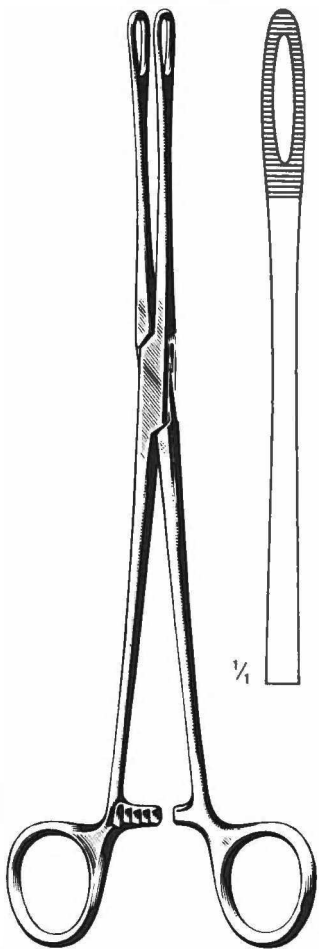
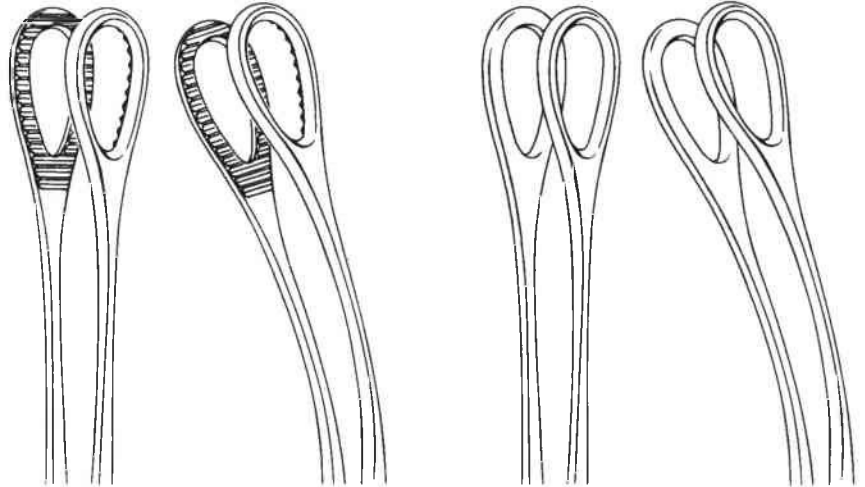

FOERSTER

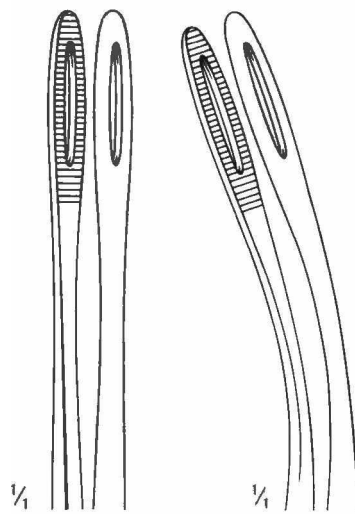

H116-17425  
25 cm

H116-17525  
25 cm



RAMPLEY  
H116-18025  
25 cm

Schwammzangen  
Dressing Forceps  
Pinces à polypes  
Pinzas para tapones  
Pinze per tamponi

16

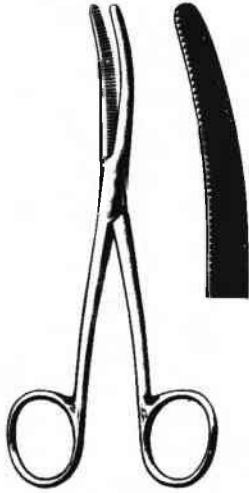

BRYANT  
H116-20713  
13 cm



cm	LISTER (Sinus)
13	H116-21013
16	H116-21016
18	H116-21018

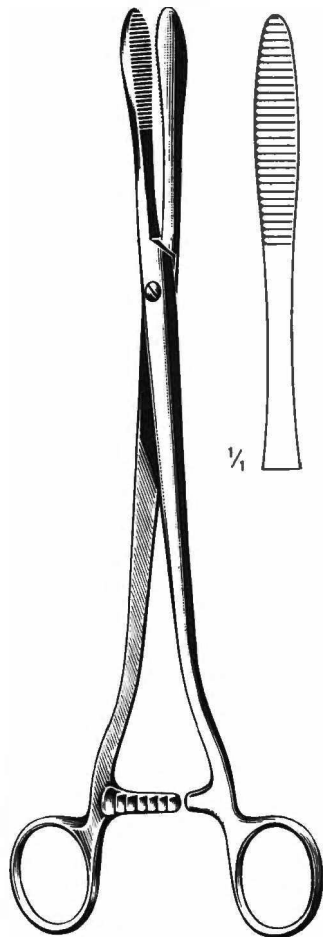

COLLIN  
H116-22025  
25 cm

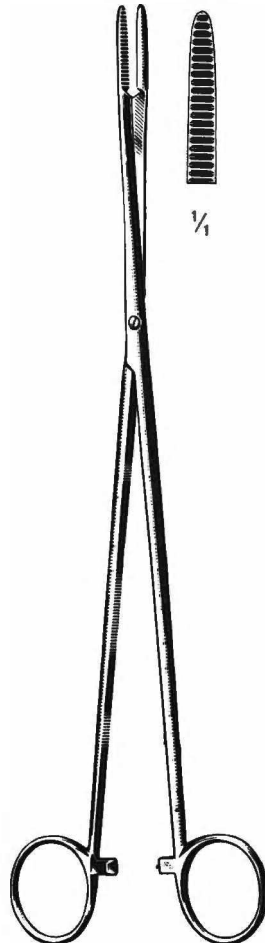

PELKMANN  
H116-22625  
25 cm

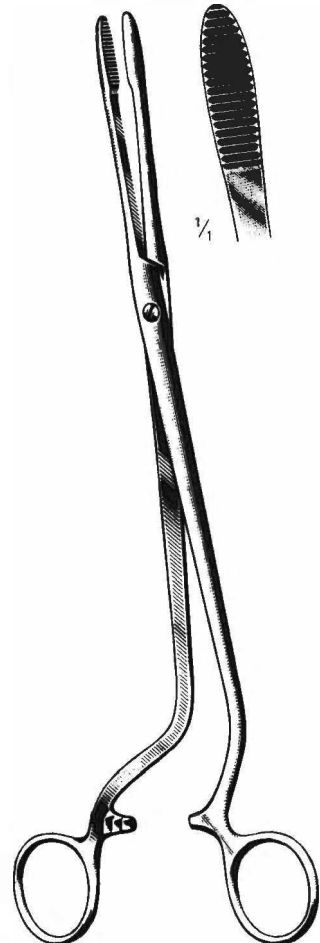

CHERON  
H116-22925  
25 cm



Schwammzangen  
Dressing Forceps  
Pincès à polypes  
Pinzas para tapones  
Pinze per tamponi

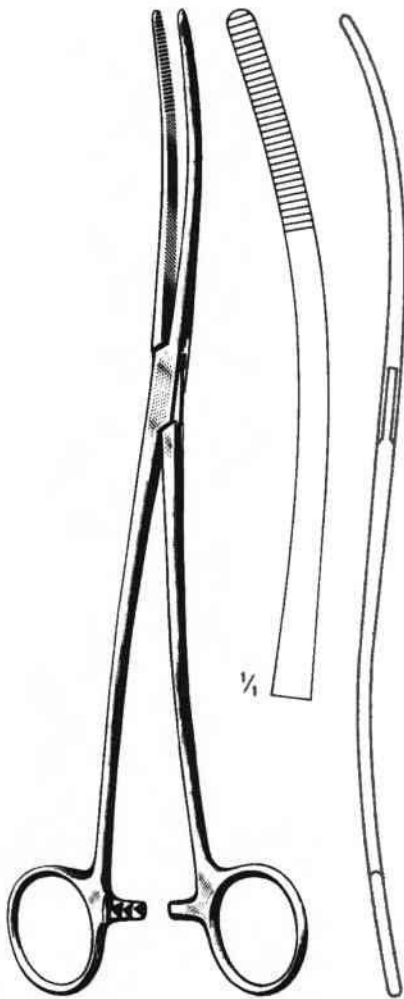

— BOZEMANN —  
H116-23026 26 cm H116-23126

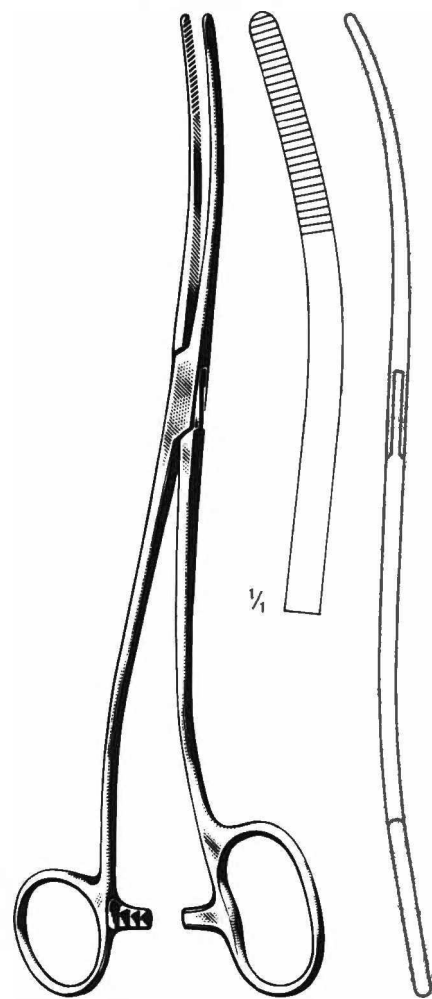

BOZEMANN-DOUGLAS  
H116-23326  
26 cm

Wundhaken  
Retractors  
Ecarteurs  
Separadores  
Divaricatori

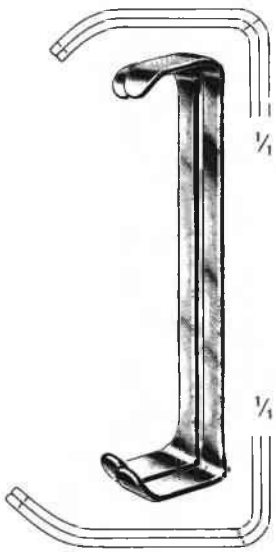

FARABEUH  
H118-10212  
12 cm

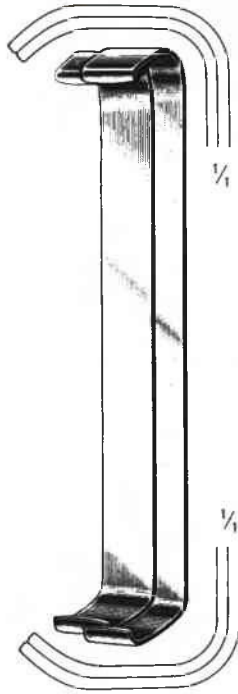

FARABEUH  
H118-10215  
15 cm

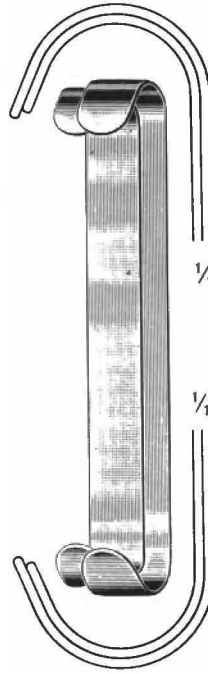

PARKER  
H118-11013  
13,5 cm



PARKER  
H118-11018  
18 cm

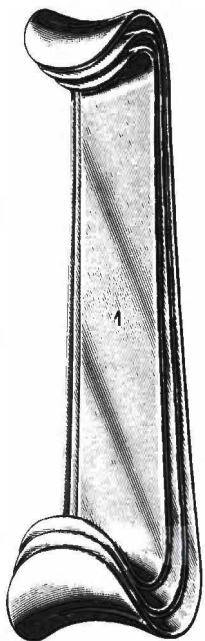

ROUX  
H118-12000

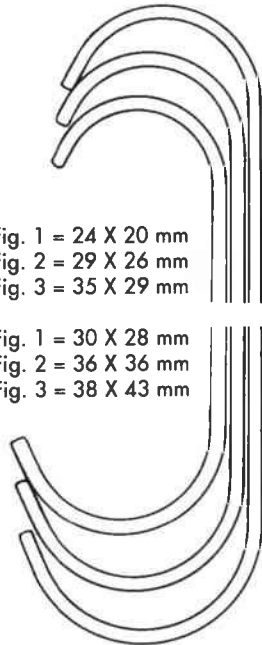

Fig. 1 = 24 X 20 mm  
Fig. 2 = 29 X 26 mm  
Fig. 3 = 35 X 29 mm

Fig. 1 = 30 X 28 mm  
Fig. 2 = 36 X 36 mm  
Fig. 3 = 38 X 43 mm

		Fig.	cm
H118-12014	1	14	
H118-12015	2	15	
H118-12017	3	17	



ROUX Baby  
H118-12213  
13 cm

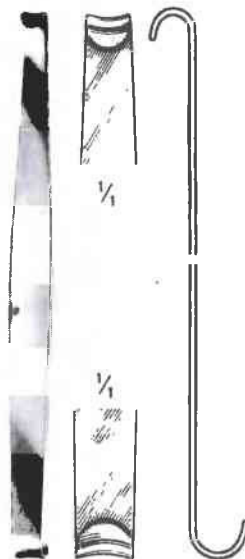

ROUX mini  
H118-12415  
15 cm

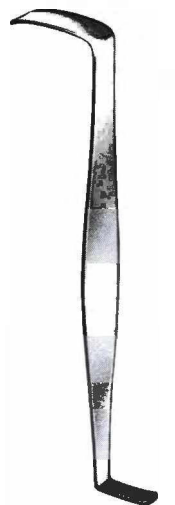

CRILE  
H118-12711  
11,5 cm

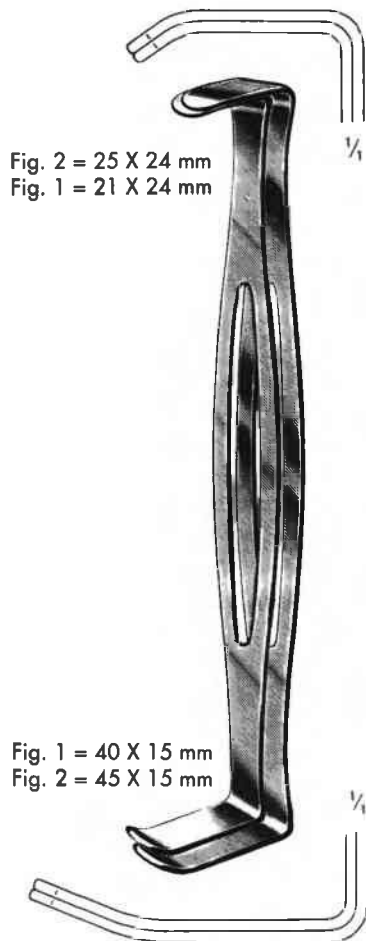

Fig. 2 = 25 X 24 mm  
Fig. 1 = 21 X 24 mm

Fig. 1 = 40 X 15 mm  
Fig. 2 = 45 X 15 mm

US Army (PARKER-LANGENBECK)  
H118-13121  
21 cm



Fig. 2 = 47 X 13 mm  
Fig. 1 = 42 X 13 mm

Fig. 1 = 42 X 26 mm  
Fig. 2 = 46 X 26 mm

MATHIEU  
H118-13420  
20 cm

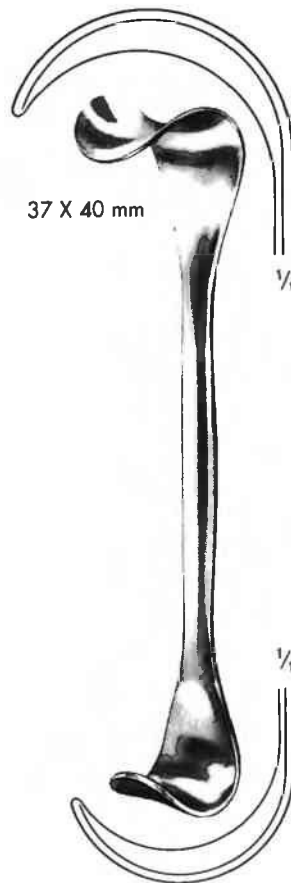

37 X 40 mm

GOELET  
H118-13519  
19 cm

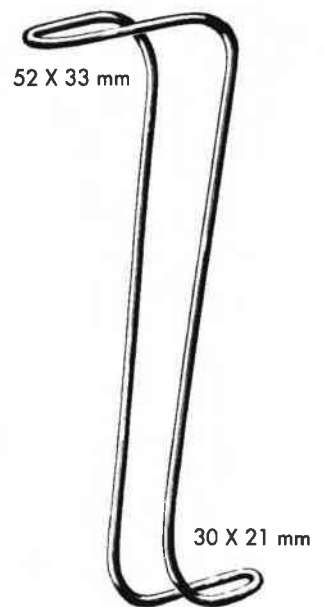

52 X 33 mm

30 X 21 mm

COLLIN-HARTMANN  
H118-13716  
16 cm

Wundhaken  
Retractors  
Ecarteurs  
Separadores  
Divaricatori

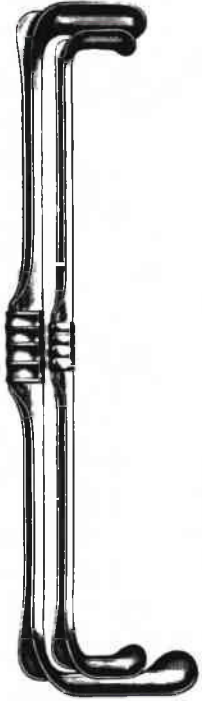

RICHARDSON-EASTMAN  
H118-14000

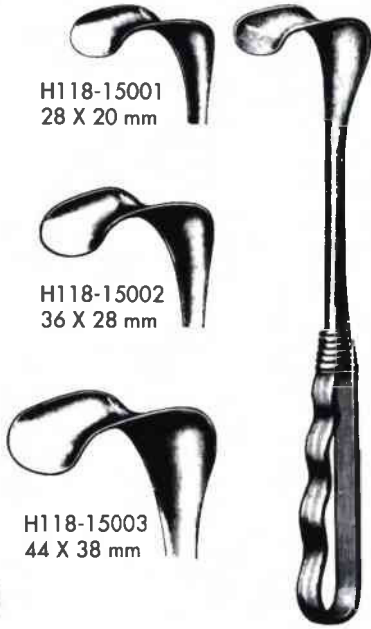

H118-15001  
28 X 20 mm

H118-15002  
36 X 28 mm

H118-15003  
44 X 38 mm

RICHARDSON



RICHARDSON Grip  
H118-15225 20 X 25 mm  
H118-15231 25 X 31 mm  
H118-15238 38 X 38 mm  
H118-15251 19 X 51 mm (Append.)  
H118-15264 41 X 64 mm



65 X 50 mm

KELLY  
H118-15626  
26 cm

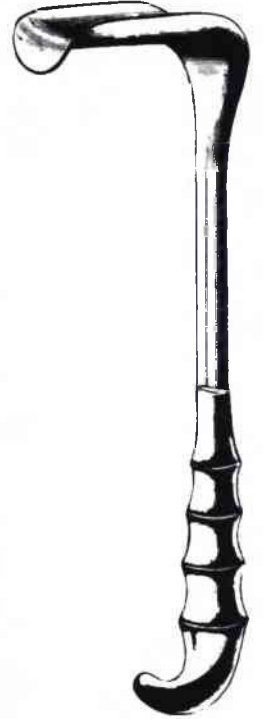

KELLY Grip  
H118-15851 38 X 51 mm  
H118-15864 51 X 64 mm  
H118-15876 64 X 76 mm  
H118-15882 70 X 82 mm

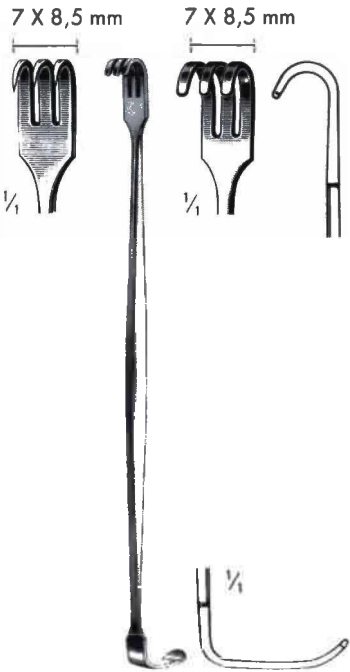

7 X 8,5 mm  
7 X 8,5 mm  
1/4  
1/4  
1/4  
SENN  
H118-16017 17 cm H118-16117



RIBBON  
H118-16812 12 X 200 mm  
H118-16817 17 X 200 mm  
H118-16825 25 X 250 mm



RIBBON  
H118-17025 25 X 330 mm  
H118-17032 32 X 330 mm  
H118-17040 40 X 330 mm  
H118-17050 50 X 330 mm



HABERER  
H118-17417 17/25X200 mm  
H118-17425 25/30X250 mm  
H118-17437 37/45X300 mm



REVERDIN  
H118-17528  
28 cm

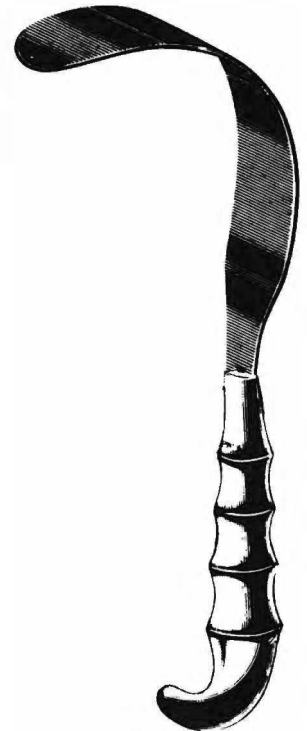
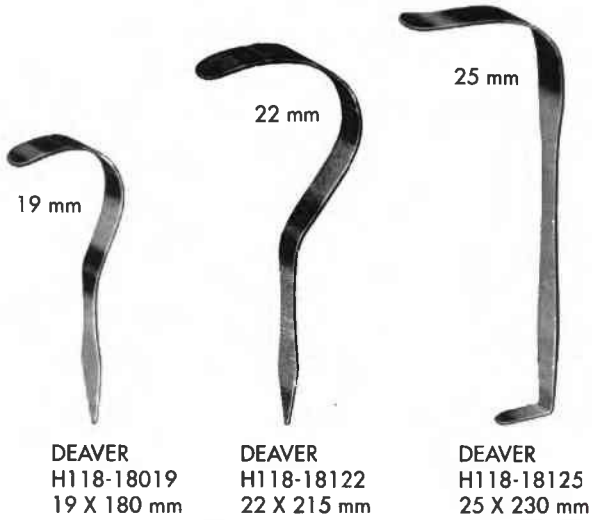

DEAVER Grip

H118-18925	25 X 310 mm
H118-18938	38 X 310 mm
H118-18950	50 X 310 mm



HARRINGTON

H118-19125	25 X 230 mm
H118-19140	40 X 320 mm
H118-19162	62 X 320 mm



Wundhaken  
Retractors  
Ecarteurs  
Separadores  
Divaricatori

18

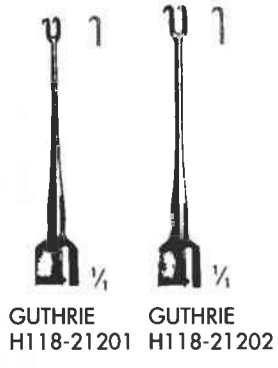
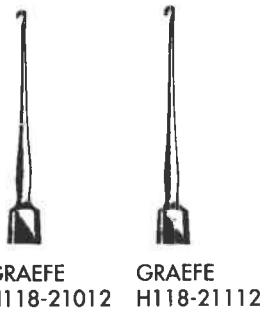

cm	FRAZIER
13	H118-21413
18	H118-21418

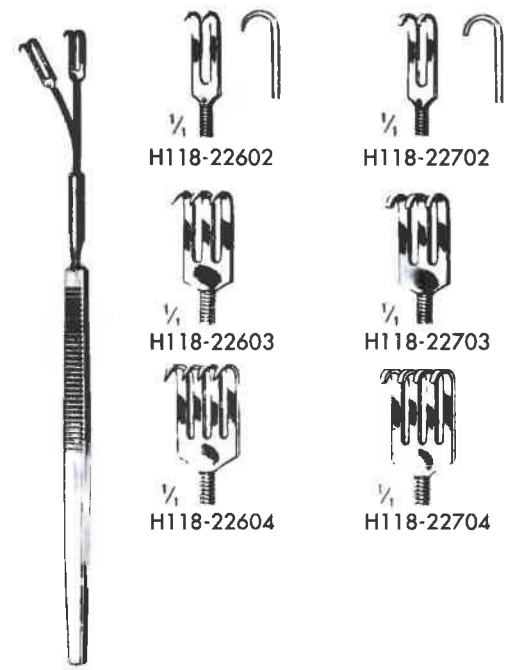
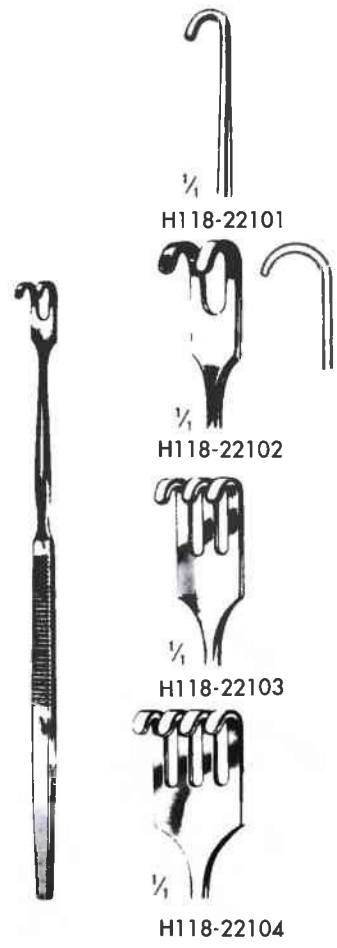
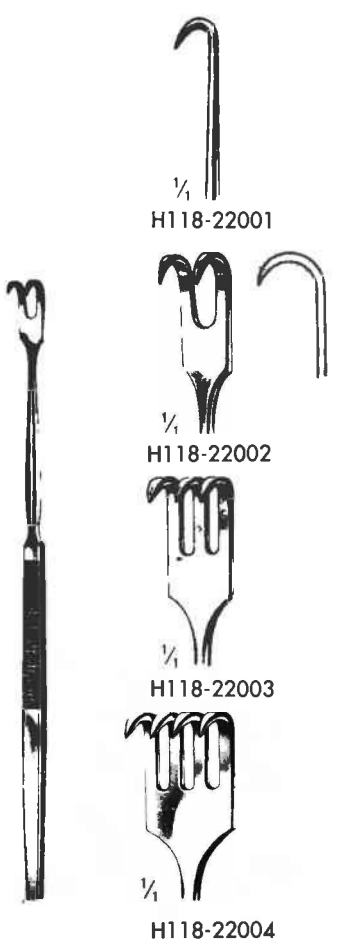
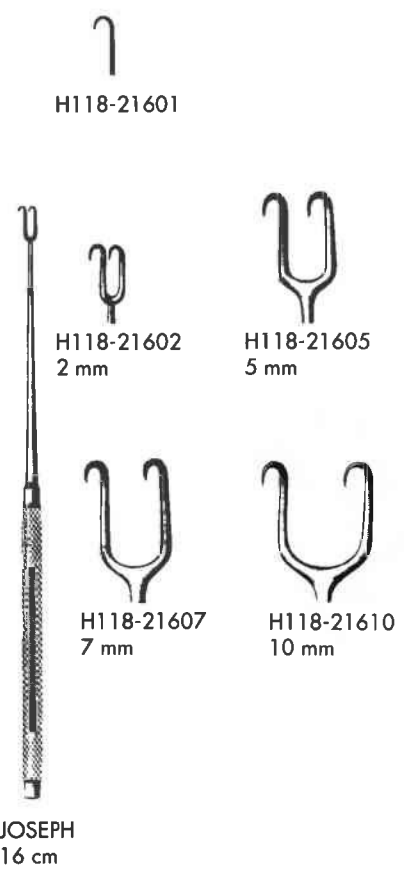



DESMARRES  
16 cm



H118-23012  
12 mm



H118-23014  
14 mm



H118-23016  
16 mm



H118-23018  
18 mm



CUSHING  
20 cm



H118-23208  
8 mm



H118-23210  
10 mm



H118-23212  
12 mm



H118-23214  
14 mm

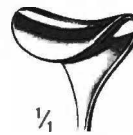

H118-23216  
16 mm



H118-23218  
18 mm



CUSHING  
H118-23420  
20 cm



CUSHING  
H118-23421  
21,5 cm

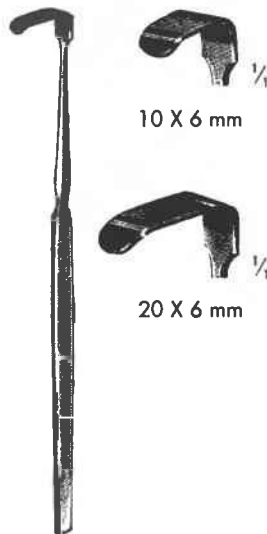

SENN-GREEN  
H118-24010 10 X 6 mm  
H118-24020 20 X 6 mm



10 X 6 mm



20 X 6 mm

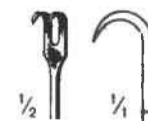

H118-27002

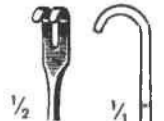

H118-27102



H118-27003



H118-27103



H118-27004



H118-27104



H118-27006



H118-27106



VOLKMANN  
11,5 cm

Wundhaken  
Retractors  
Ecarteurs  
Separadores  
Divaricatori

18

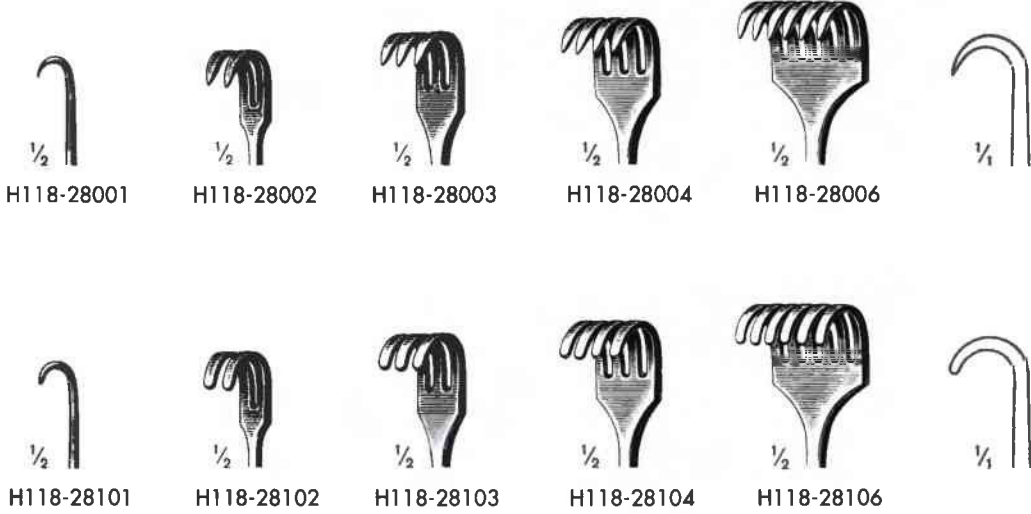

H118-28001

H118-28002

H118-28003

H118-28004

H118-28006

H118-28101

H118-28102

H118-28103

H118-28104

H118-28106



VOLKMANN  
21,5 cm

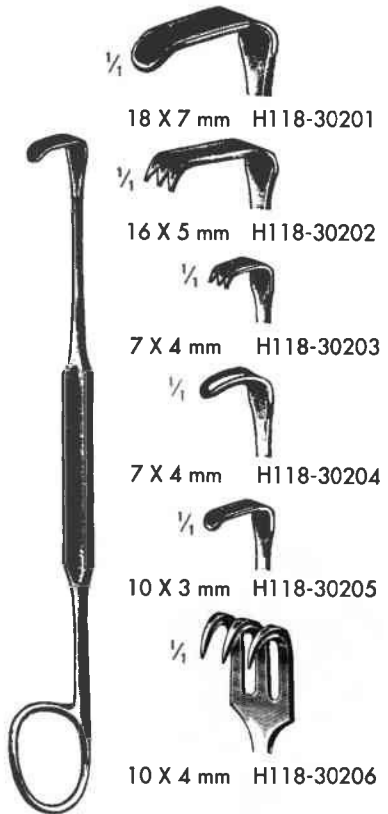

18 X 7 mm H118-30201

16 X 5 mm H118-30202

7 X 4 mm H118-30203

7 X 4 mm H118-30204

10 X 3 mm H118-30205

10 X 4 mm H118-30206

MEYERDING  
18 cm

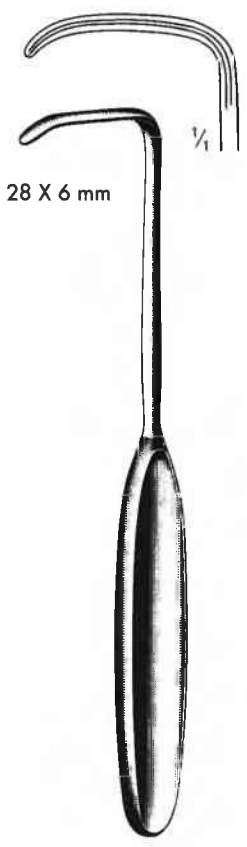

28 X 6 mm

LAHEY  
H118-30419  
19 cm

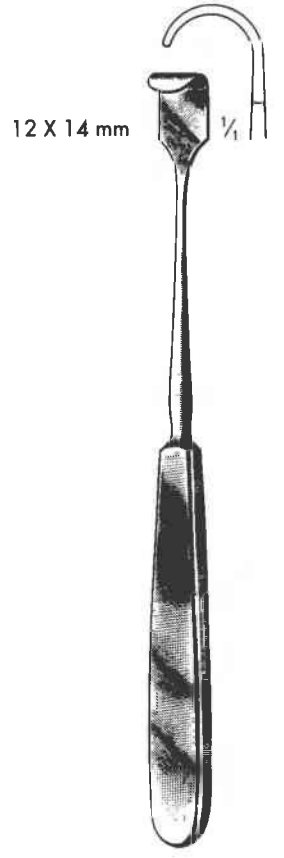

12 X 14 mm

LITTLE  
H118-30620  
20 cm

Wundhaken  
Retractors  
Ecarteurs  
Separadores  
Divaricatori

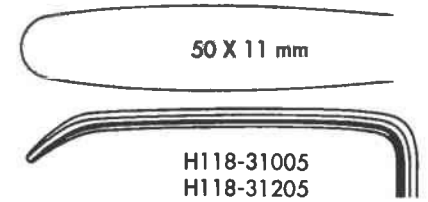
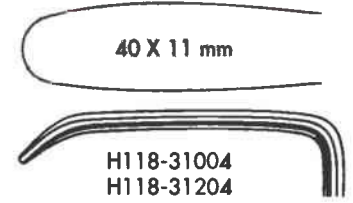
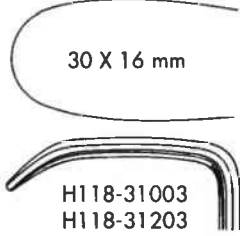
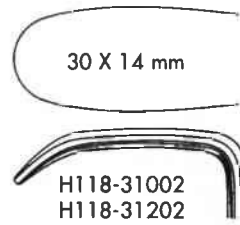
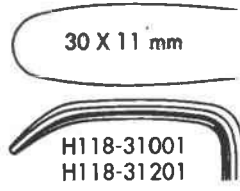
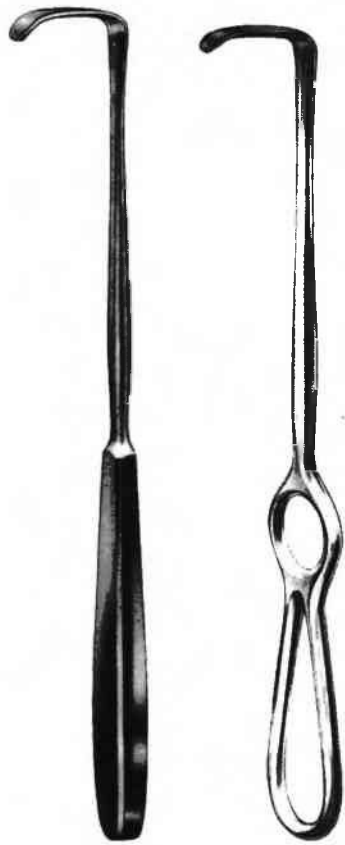

H118-31001  
-H118-31005  
22 cm

H118-31201  
-H118-31205  
21 cm

LANGENBECK

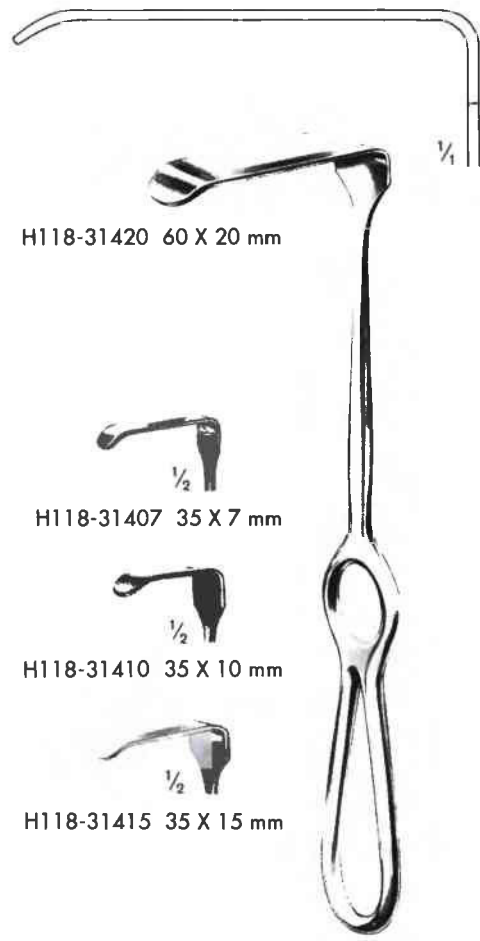

H118-31420 60 X 20 mm

H118-31407 35 X 7 mm

H118-31410 35 X 10 mm

H118-31415 35 X 15 mm

LANGENBECK  
H118-31407 - H118-31420  
21 cm

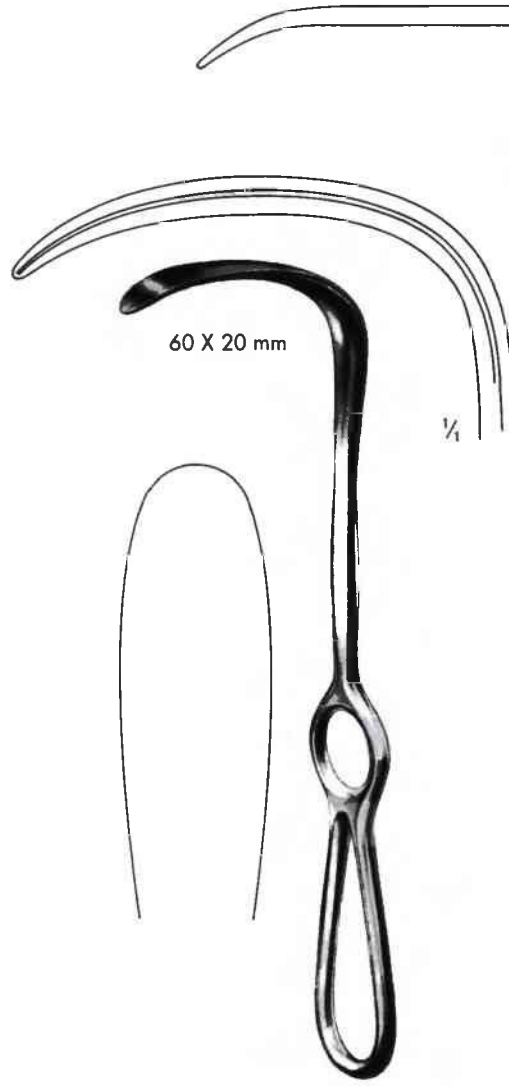

60 X 20 mm

LANGENBECK  
H118-31521  
21 cm

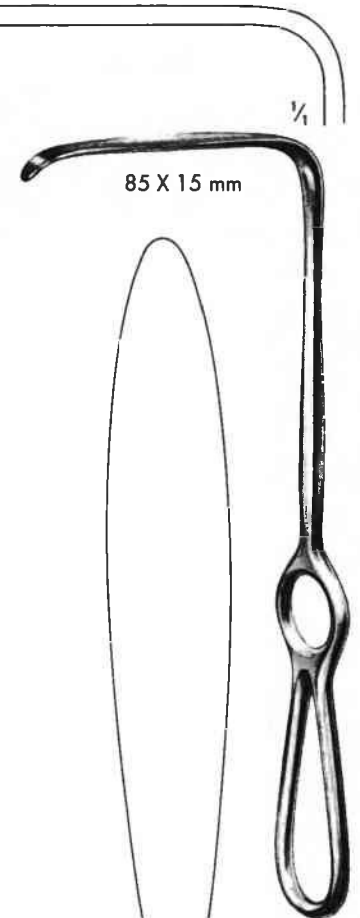

85 X 15 mm

LANGENBECK  
H118-31721  
21 cm

Wundhaken  
Retractors  
Ecarteurs  
Separadores  
Divaricatori

18

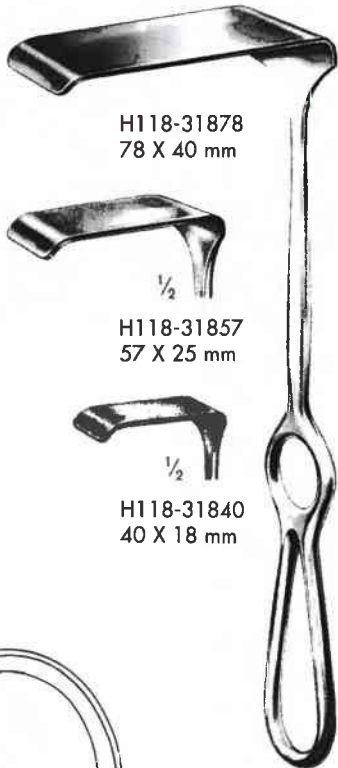

H118-31878  
78 X 40 mm



H118-31857  
57 X 25 mm



H118-31840  
40 X 18 mm

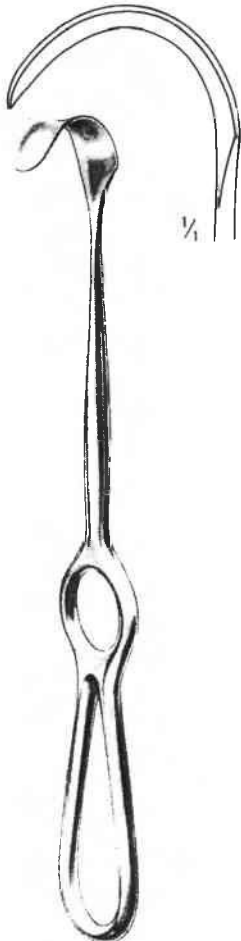

H118-31840 - H118-31878  
23 cm



H118-34414  
14 X 17 mm  
21,5 cm



H118-34420  
20 X 22 mm  
22 cm



H118-34426  
26 X 30 mm  
23,5 cm

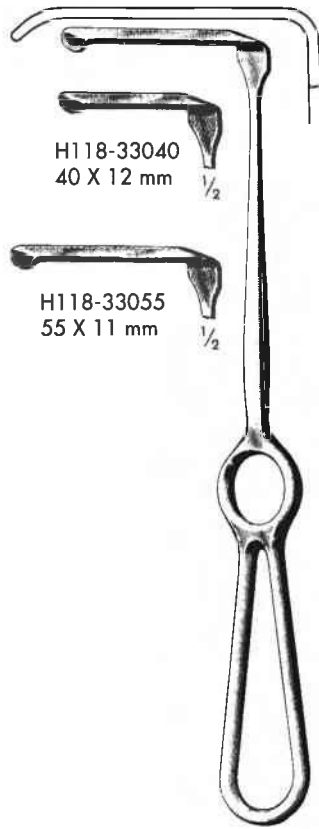

H118-33040  
40 X 12 mm  
1/2

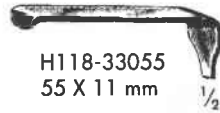

H118-33055  
55 X 11 mm  
1/2

KOCHER  
H118-33040 - H118-33055  
19 cm

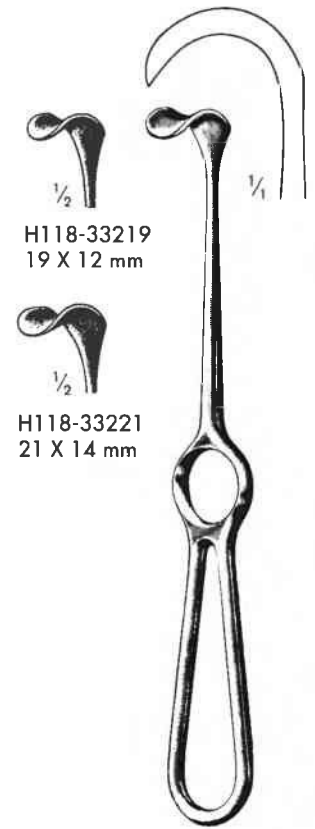

H118-33219  
19 X 12 mm



H118-33221  
21 X 14 mm

KOCHER  
H118-33219 - H118-33221  
19 cm



MIDDELDORPF  
H118-34414 - H118-34426



GREEN  
H118-34822  
22 cm

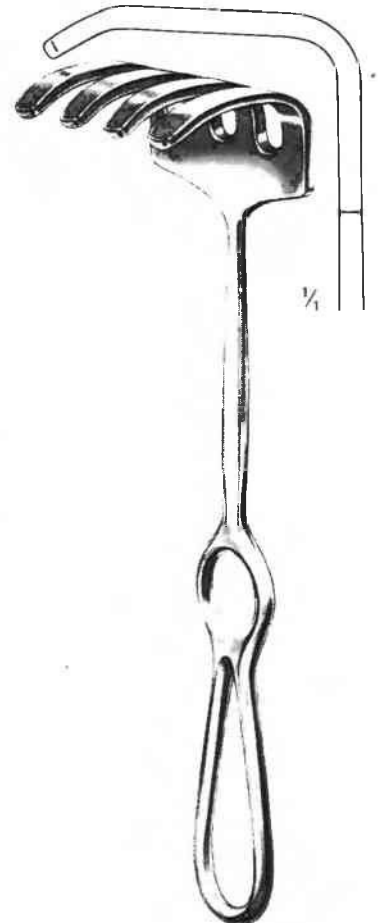

OLLIER  
H118-36004  
22,5 cm

KOCHER	mm
H118-34010	40 X 10
H118-34015	40 X 15
H118-34020	40 X 20

22 cm



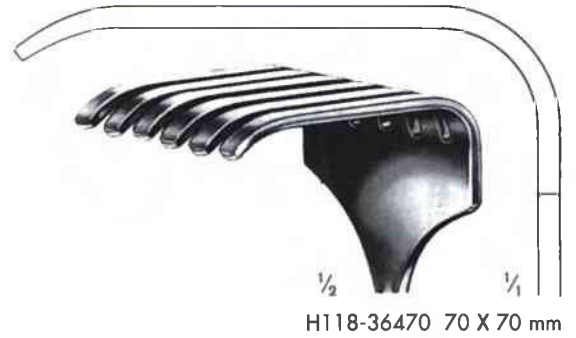
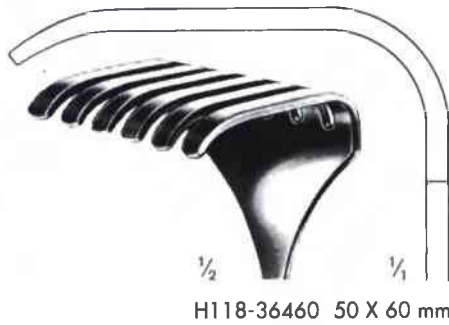
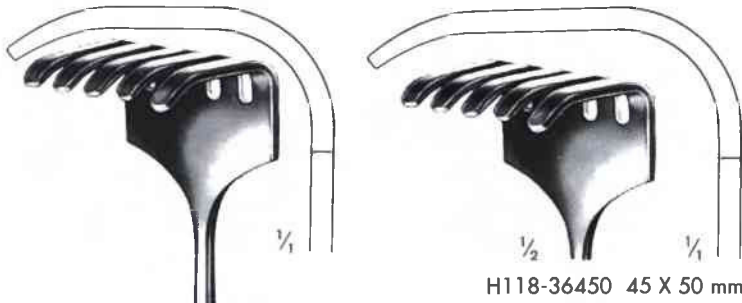

ISRAEL  
H118-36440  
40 X 40 mm  
25 cm

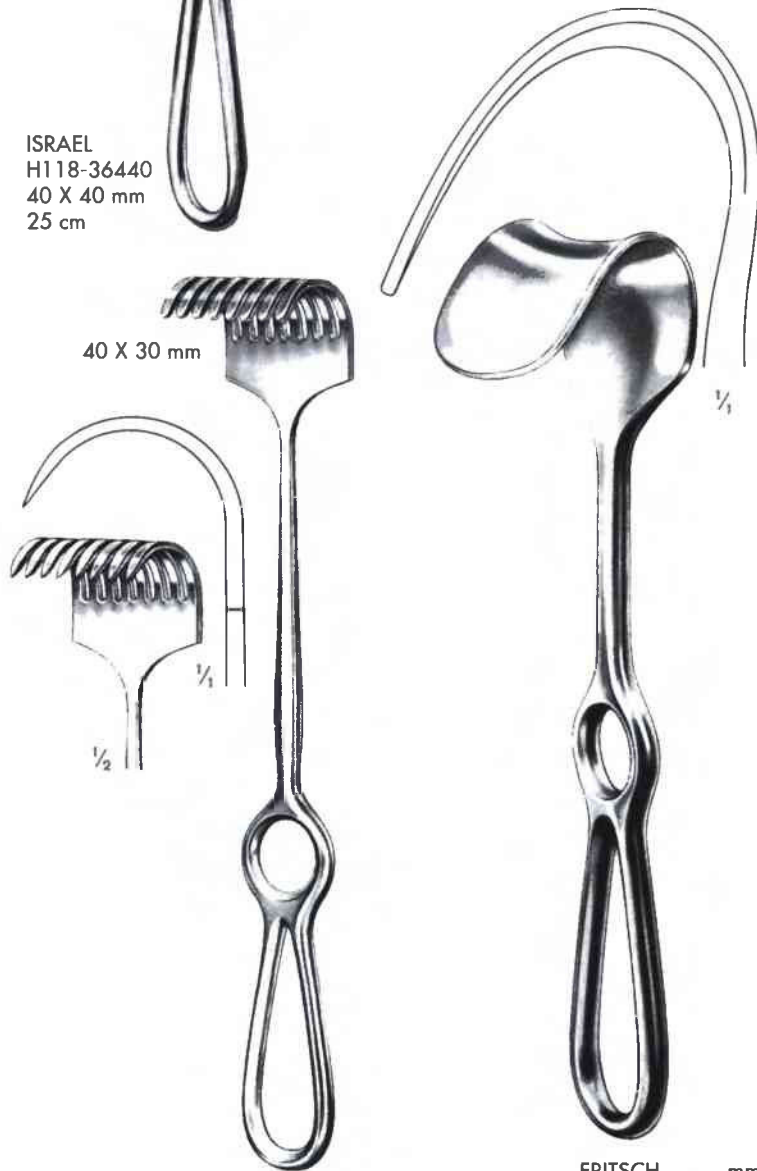

— KOERTE —  
H118-36608 23,5 cm H118-36708

FRITSCH	mm
H118-37040	45 X 40
H118-37050	45 X 50
H118-37060	45 X 60
H118-37075	45 X 75

24 cm

KOCHER  
H118-37222  
22,5 cm

KOCHER	mm
H118-37445	80 X 45
H118-37455	80 X 55
H118-37465	80 X 65

25 cm

Wundhaken  
Retractors  
Ecarteurs  
Separadores  
Divaricatori

18



50 X 85 mm

DOYEN  
H118-37825  
25 cm

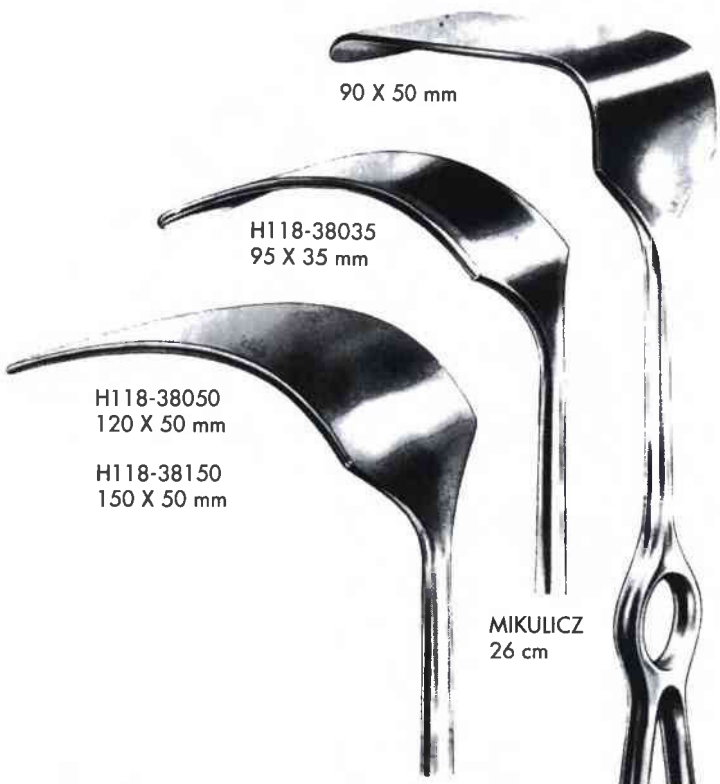

90 X 50 mm

H118-38035  
95 X 35 mm

H118-38050  
120 X 50 mm

H118-38150  
150 X 50 mm

MIKULICZ  
26 cm

MIKULICZ  
26 cm

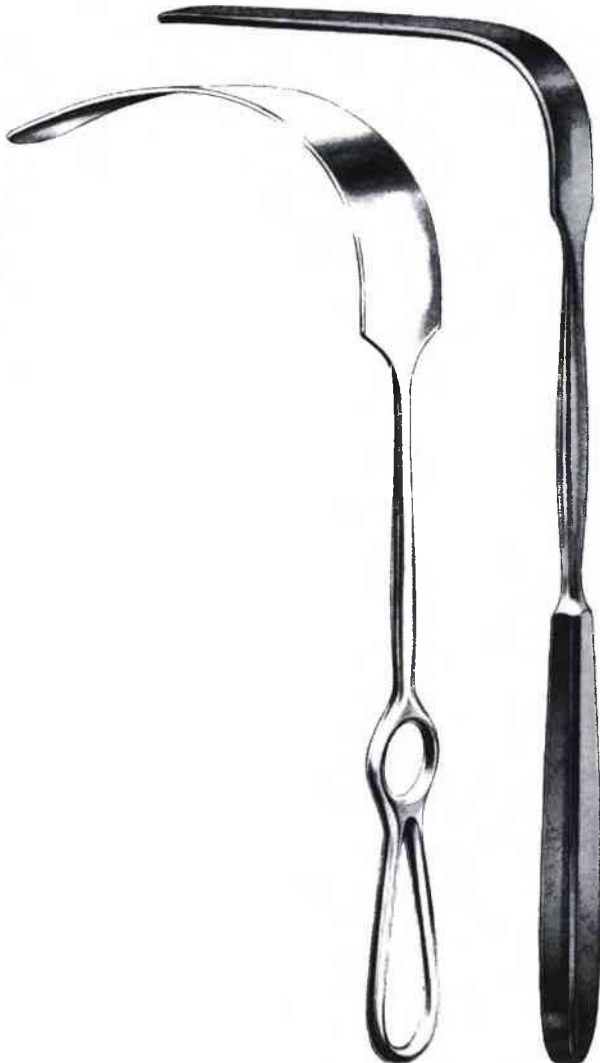

H118-48282  
82 X 28 mm

H118-48273  
73 X 28 mm

H118-48245  
45 X 25 mm

MIKULICZ  
H118-38250  
26 cm

mm	KELLY	SIMON	mm
160 X 38	H118-38538	H118-48022	115 X 22
160 X 57	H118-38557	H118-48027	115 X 27
	27 cm	28 cm	

HEANEY  
H118-48245 - H118-48282  
27 cm

H118-49065  
115 X 65 mm

H118-49043  
108 X 43 mm

H118-49022  
82 X 22 mm



125 X 37 mm

SAUERBRUCH  
H118-49225  
25 cm

CORYLLOS (Thorax)  
H118-49022 - H118-49065  
24 cm

H118-49445  
45 X 15 mm

H118-49460  
60 X 23 mm

H118-49475  
75 X 20 mm



SAUERBRUCH  
H118-49445 - H118-49475  
22,5 cm



DAVIDSON (Scapula)  
H118-49650  
75 X 50 mm



DAVIDSON (Scapula)  
H118-49690  
75 X 90 mm

Wundsperrer  
Retractors  
Ecarteurs  
Separadores  
Divaricatori

18

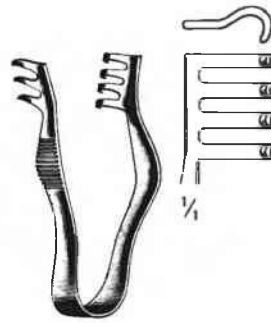

FINSEN  
H118-61007 7 cm H118-61107

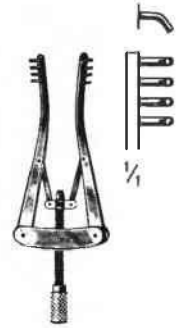

ALM  
H118-62007 7 cm H118-62107  
H118-62010 10 cm H118-62110

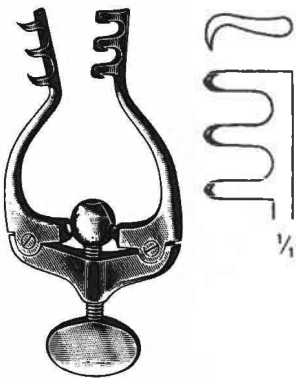

JANSEN  
H118-63010  
10 cm

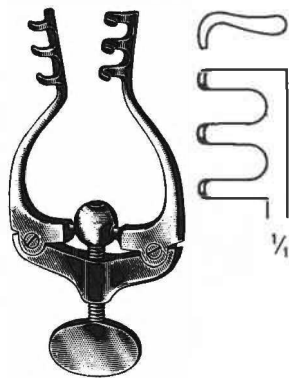

JANSEN  
H118-63110  
10 cm



DIMEDA  
H118-63410 10 cm H118-63510

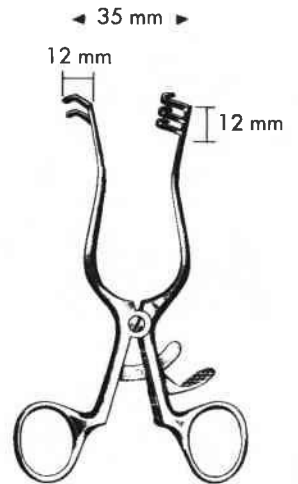

WEITLANER  
H118-65010 11,5 cm H118-65110

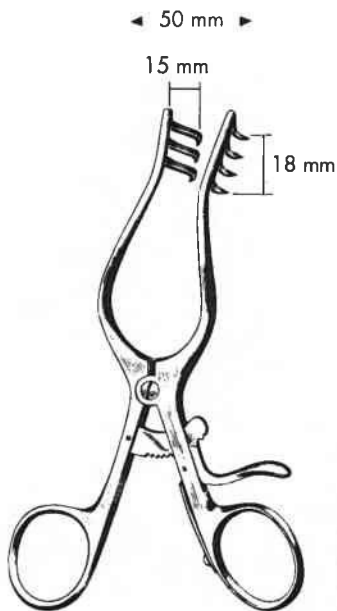

WEITLANER-WULLSTEIN  
H118-65413 13 cm H118-65513



PLESTER  
H118-65711  
11 cm

PLESTER  
H118-65911  
11 cm

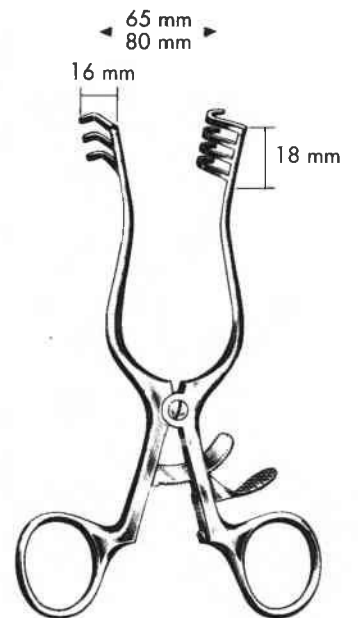

WEITLANER  
H118-67014 14,0 cm H118-67114  
H118-67016 16,5 cm H118-67116  
H118-67020 20,0 cm H118-67120





ADSON  
H118-68019 19 cm H118-68119

ADSON  
H118-68226 - H118-68326  
26,5 cm

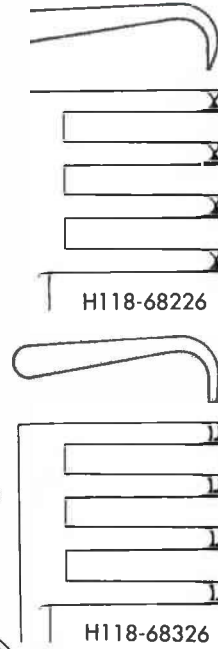

ADSON  
H118-68632  
32 cm

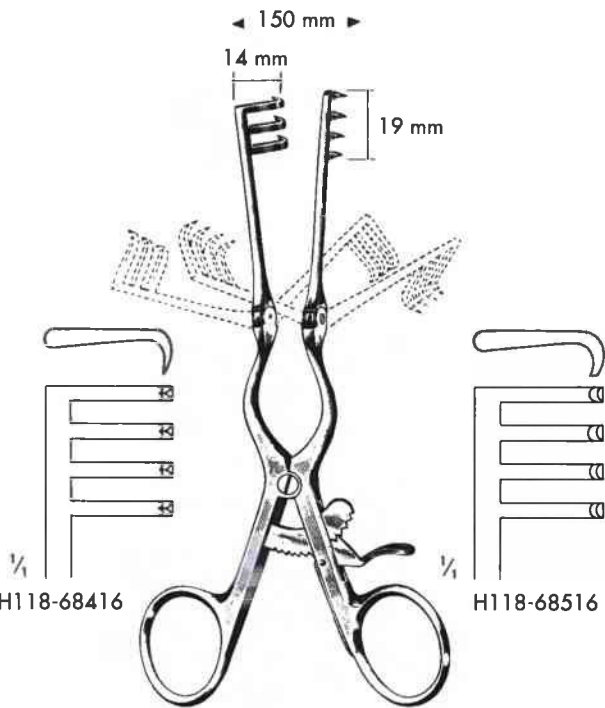

ADSON Baby  
H118-68416 - H118-68516  
16 cm



Wundsperrer  
Retractors  
Ecarteurs  
Separadores  
Divaricatori

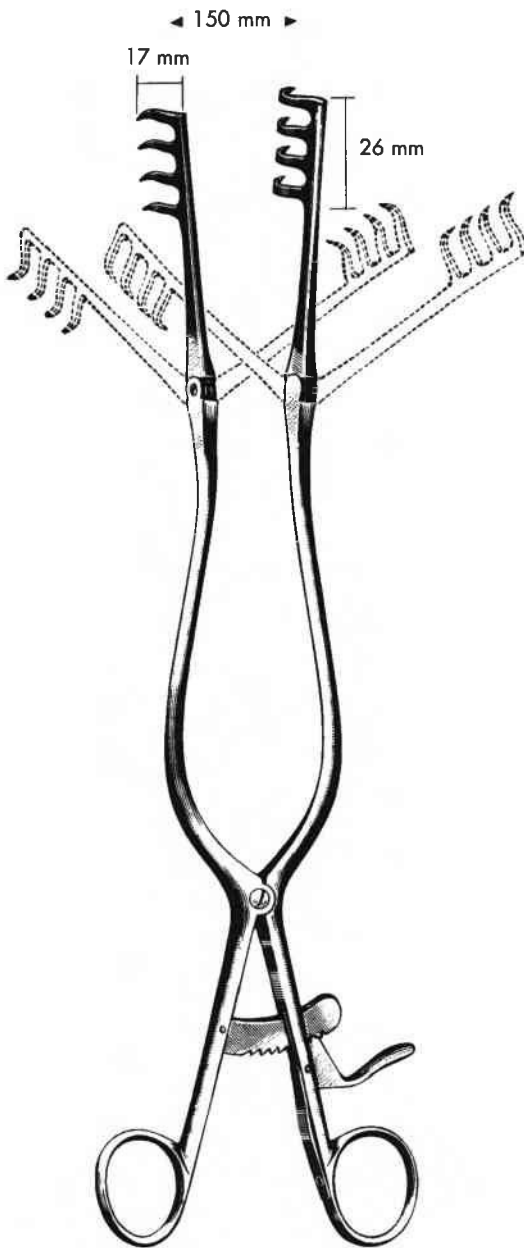

BECKMANN  
H118-69031  
31 cm



BECKMANN-EATON  
H118-69232  
32 cm



MOLLISON  
H118-69315  
15 cm



DARLING  
H118-69618  
18 cm



DARLING  
H118-69818  
18 cm



CLOWARD  
H118-71000  
H118-71001

ohne Valven · without blades  
sans valves · sin valvas · senza valve

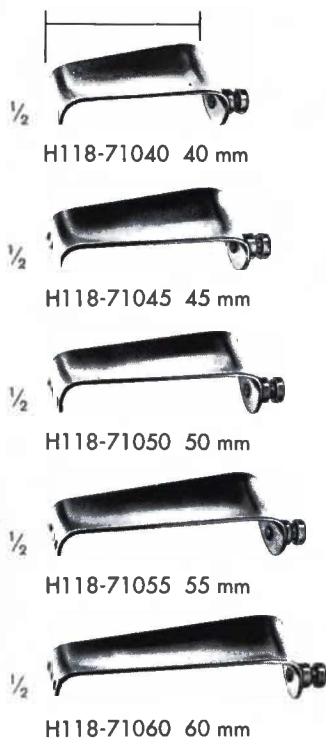

CLOWARD  
H118-71100  
H118-71101

ohne Valven · without blades  
sans valves · sin valvas · senza valve

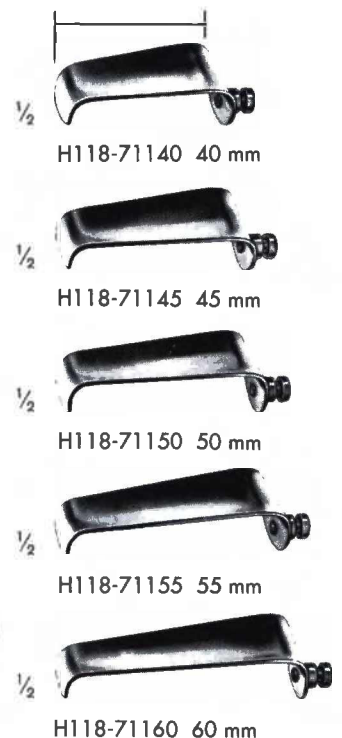

Wundspreizer, cerv. Wirbelsäule  
Retractors, Cervical Spine  
Ecarteurs, colonne cervicale  
Separadores, columna espinal  
Divaricatori, spina cervica

18

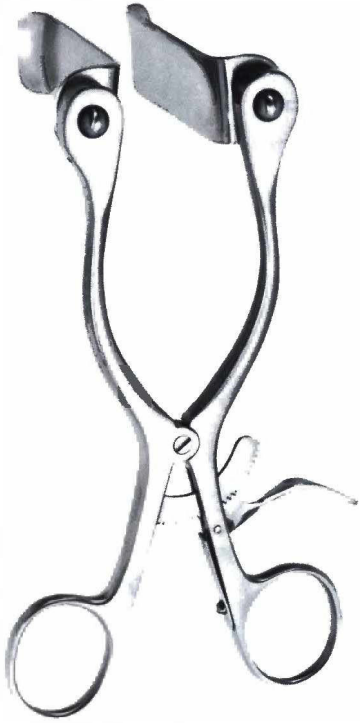

CASPAR  
H118-72000 compl.  
H118-72015 ohne Valven · without blades  
sans valves · sin valvas · senza valve

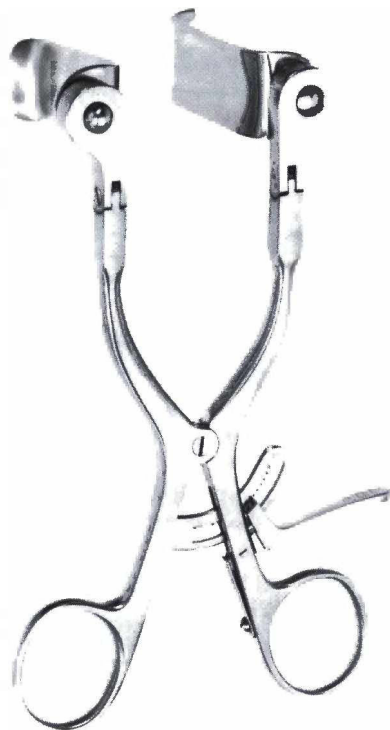

CASPAR  
H118-72100 compl.  
H118-72115 ohne Valven · without blades  
sans valves · sin valvas · senza valve



CASPAR  
H118-72400 compl.  
H118-72411



stumpf  
blunt  
mousse  
roma  
smussa

mm	CASPAR
45 X 20	H118-72045
50 X 20	H118-72050
55 X 20	H118-72055
60 X 20	H118-72060
65 X 20	H118-72065



medial

mm	CASPAR
40 X 20	H118-72440
45 X 20	H118-72445
50 X 20	H118-72450
55 X 20	H118-72455
60 X 20	H118-72460



lateral

mm	CASPAR
40 X 20	H118-72540
45 X 20	H118-72545
50 X 20	H118-72550
55 X 20	H118-72555
60 X 20	H118-72560

Wundsperrer, ges. Wirbelsäule  
Retractors, vertebral Column  
Ecarteurs, colonne vertébrale  
Separadores, columna vertebral  
Divaricatori, colonna vertebrale



CASPAR  
H118-73000 compl.  
H118-73015 ohne Valven · without blades  
sans valves · sin valvas · senza valve



CASPAR  
H118-74000 compl.  
H118-74015 ohne Valven · without blades  
sans valves · sin valvas · senza valve



mm	CASPAR
50	H118-73150



mm	CASPAR
70	H118-73170



mm	CASPAR
35 X 22	H118-73235
40 X 22	H118-73240
45 X 22	H118-73245
50 X 22	H118-73250
55 X 22	H118-73255
60 X 22	H118-73260
65 X 22	H118-73265
70 X 22	H118-73270



mm	CASPAR
35 X 37	H118-73335
40 X 37	H118-73340
45 X 37	H118-73345
50 X 37	H118-73350
55 X 37	H118-73355
60 X 37	H118-73360
65 X 37	H118-73365
70 X 37	H118-73370

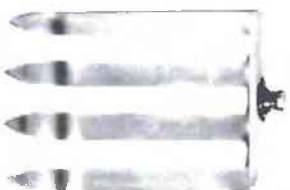

mm	CASPAR
35 X 52	H118-73435
40 X 52	H118-73440
45 X 52	H118-73445
50 X 52	H118-73450
55 X 52	H118-73455
60 X 52	H118-73460
65 X 52	H118-73465
70 X 52	H118-73470

Wundspreizer  
Retractors  
Ecarteurs  
Separadores  
Divaricatori

18

H118-74540  
40 mm



H118-74545  
45 mm



H118-74550  
50 mm



H118-74555  
55 mm



H118-74560  
60 mm



H118-74565  
65 mm



H118-74570  
70 mm



CASPAR

H118-74400 compl. incl. 7 Valven · blades  
valves · valvas · valve

H118-74417 ohne Valven · without blades  
sans valves · sin valvas · senza valve



H118-74745  
45 mm

H118-74750  
50 mm

H118-74755  
55 mm

H118-74760  
60 mm

H118-74765  
65 mm



CASPAR  
H118-74745 - H118-74765



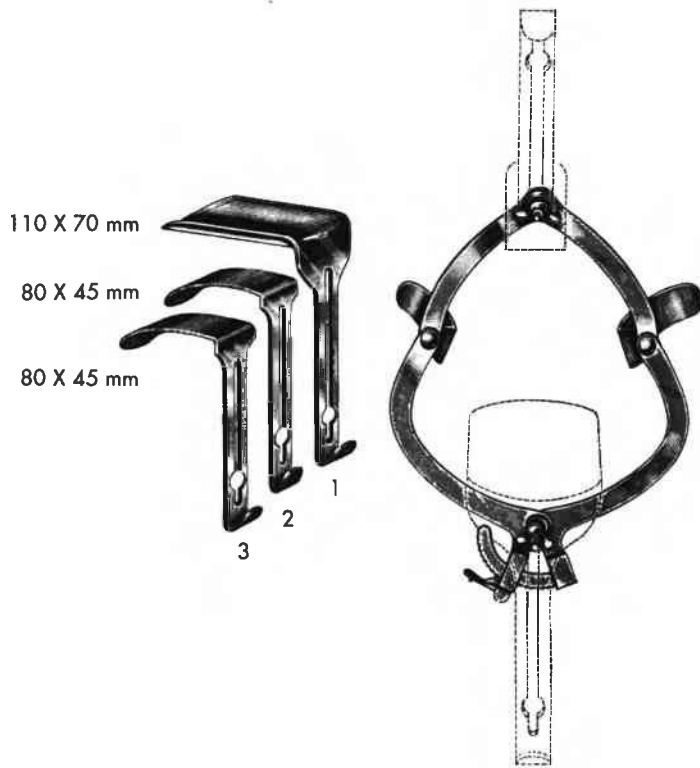

O'SULLIVAN - O'CONNOR  
H118-75400

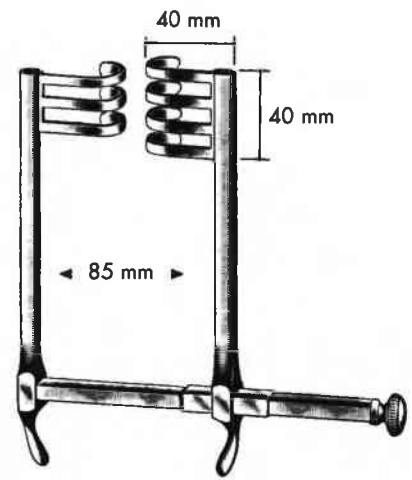

FRAZIER  
H118-75885

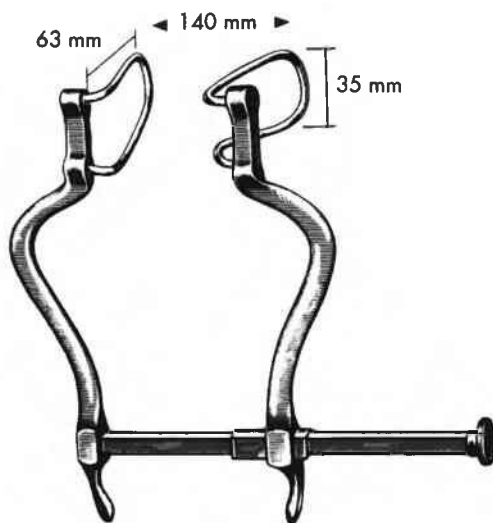

GOSSET  
H118-76014

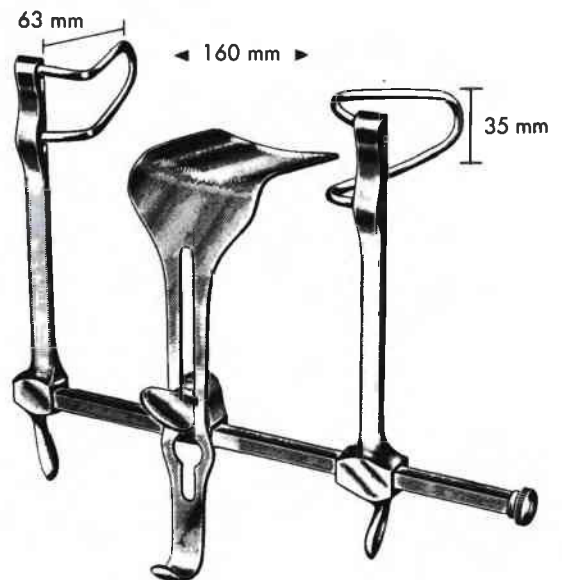

GOSSET  
H118-76216

Bauchdeckenhalter  
Abdominal Retractors  
Ecarteurs abdominaux  
Separadores abdominales  
Divaricatori addominali

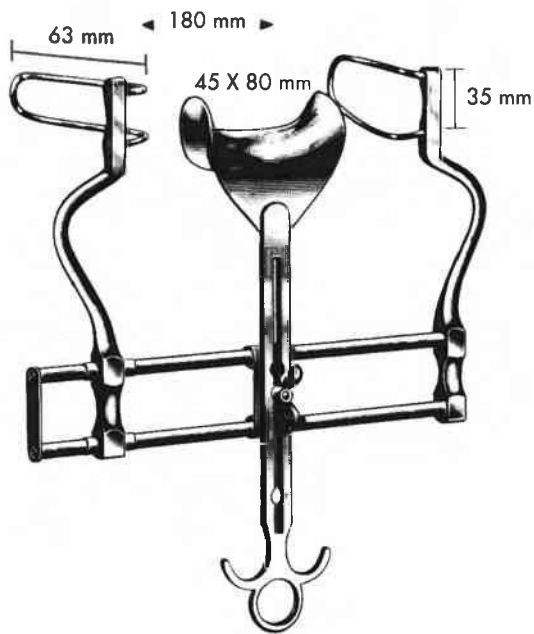

BALFOUR  
H118-76418  
18 cm

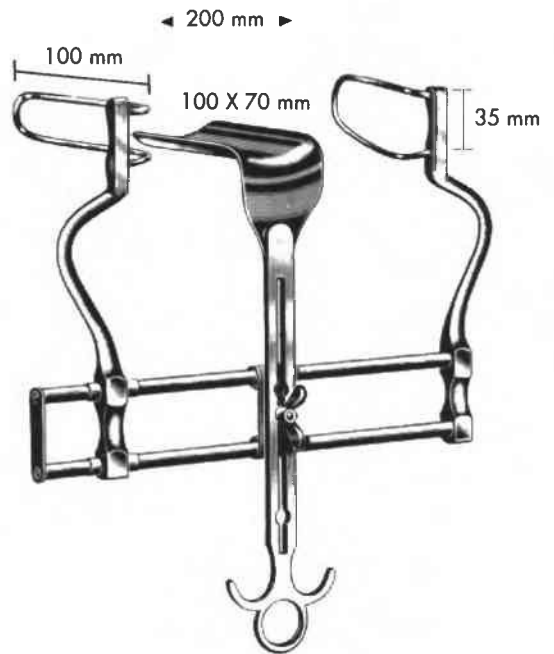

BALFOUR  
H118-76420  
20 cm

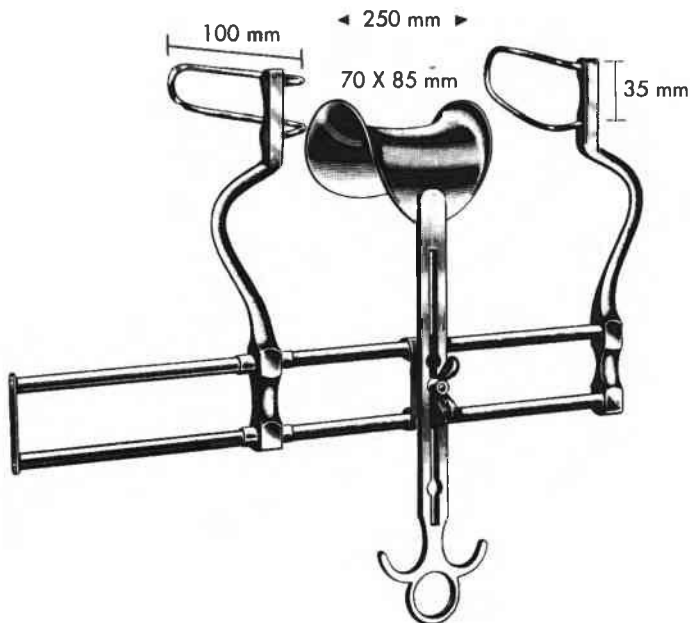

BALFOUR  
H118-76425  
25 cm

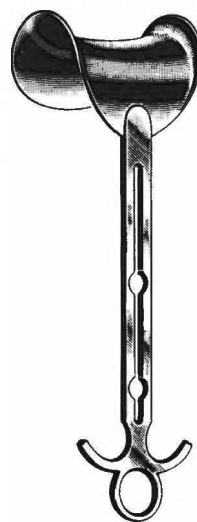

mm	BALFOUR
45 X 80	H118-76545
70 X 85	H118-76570
80 X 90	H118-76580

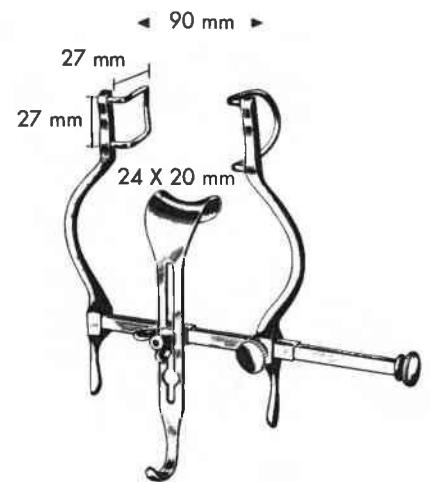

BALFOUR Baby  
H118-76690  
9 cm

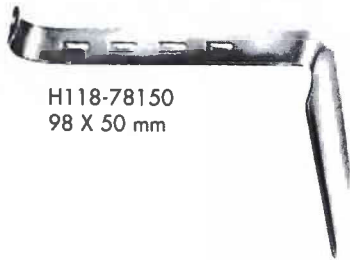

H118-78150  
98 X 50 mm

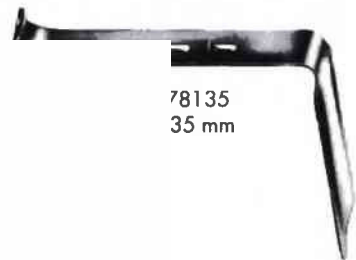

78135  
35 mm

H118-78165  
50 X 65 mm

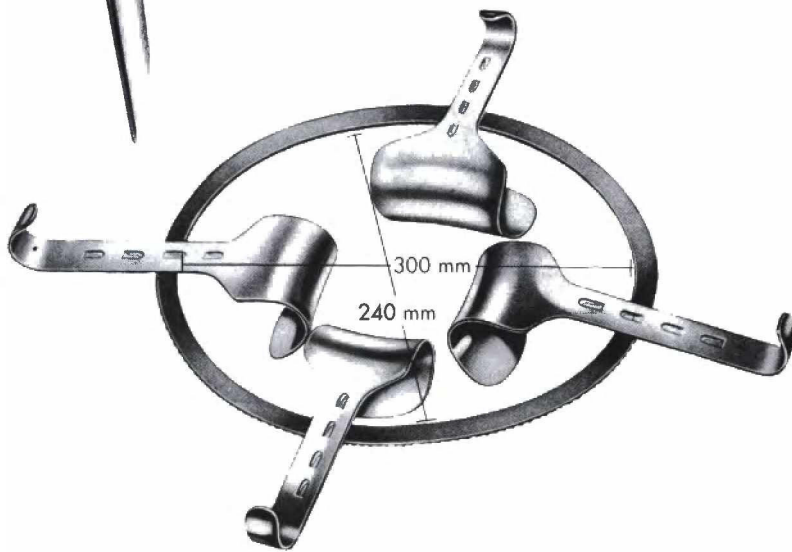

KIRSCHNER compl.  
H118-78000

H118-78165  
50 X 65 mm

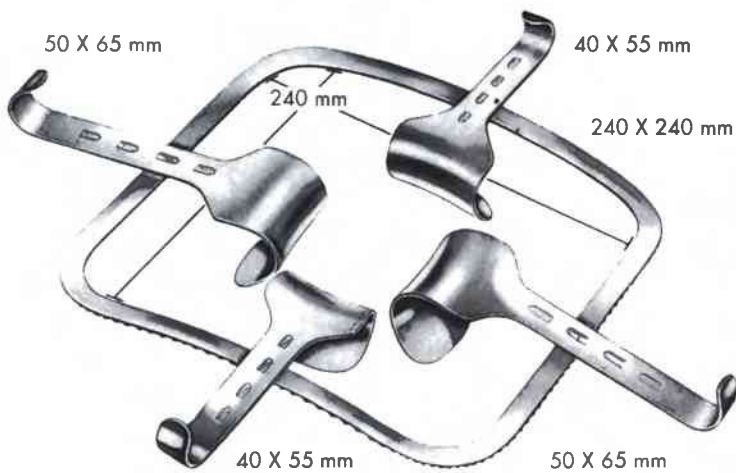

KIRSCHNER compl.  
H118-78200



H118-78155  
40 X 55 mm

H118-78165  
50 X 65 mm

Bauchdeckenhalter  
Abdominal Retractors  
Ecarteurs abdominaux  
Separadores abdominales  
Divaricatori addominali

18

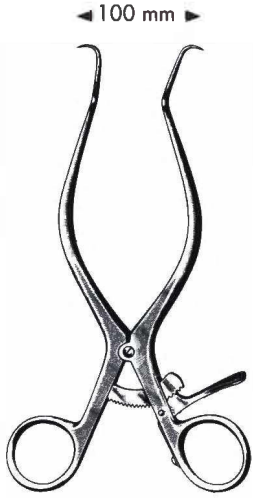

cm	GELPI
9	H118-80209
14	H118-80214
16	H118-80216
18	H118-80218

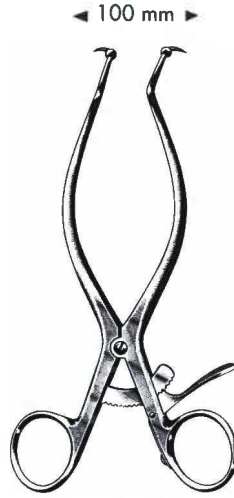

GELPI  
H118-80418  
18 cm



RIGBY  
H118-80618  
18 cm

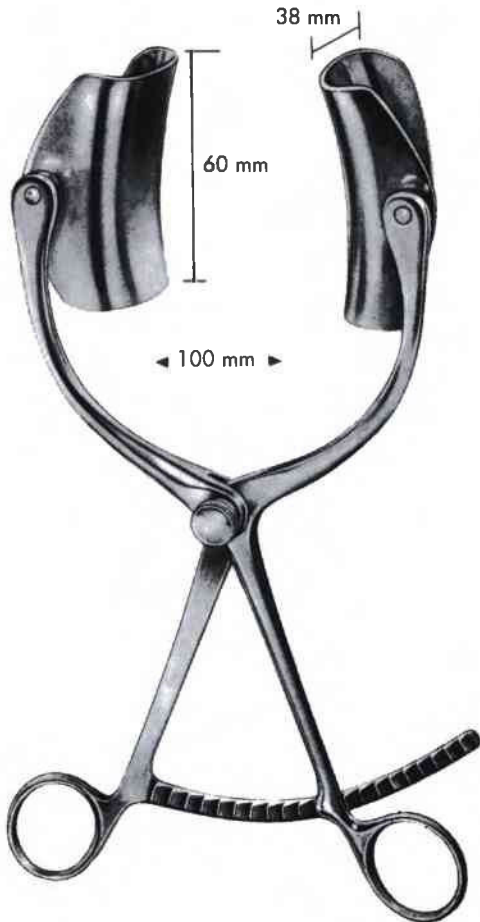

COLLIN  
H118-81022

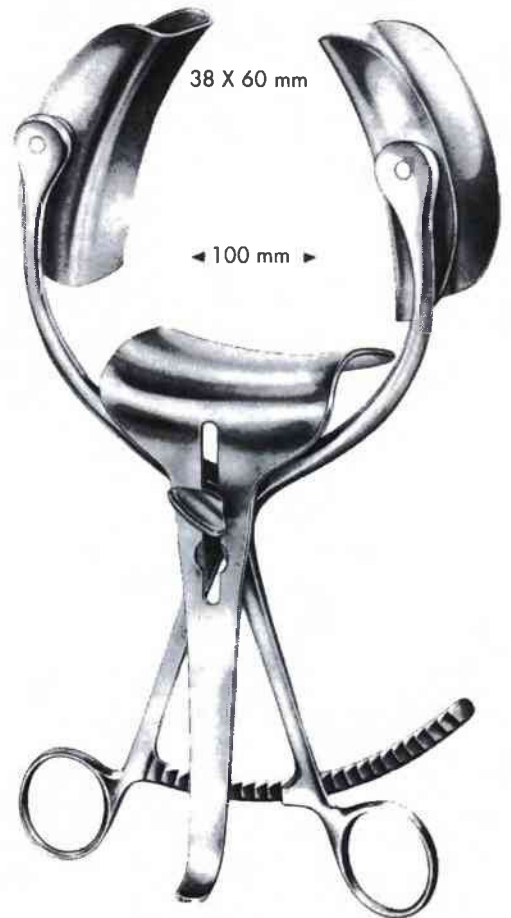

Central/mm	COLLIN
38 X 55	H118-81260
50 X 75	H118-81280

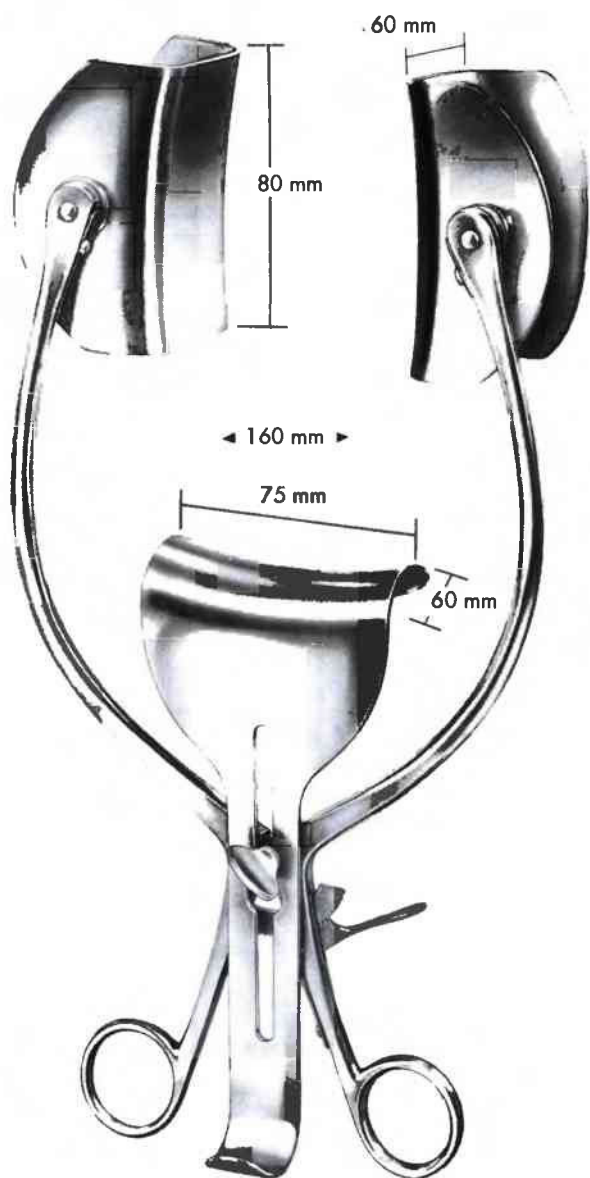

COLLIN Loktite  
H118-81600

Muskelhaken  
Muscle Retractors (Hooks)  
Ecarteurs musculaires  
Separadores (ganchos) musculares  
Divaricatori (unicini) muscolari



H118-90210  
10 cm



H118-90300



Sonden  
Probes, Directors  
Stylets, sondes  
Sondas, estiletes  
Sonde, specilli

20

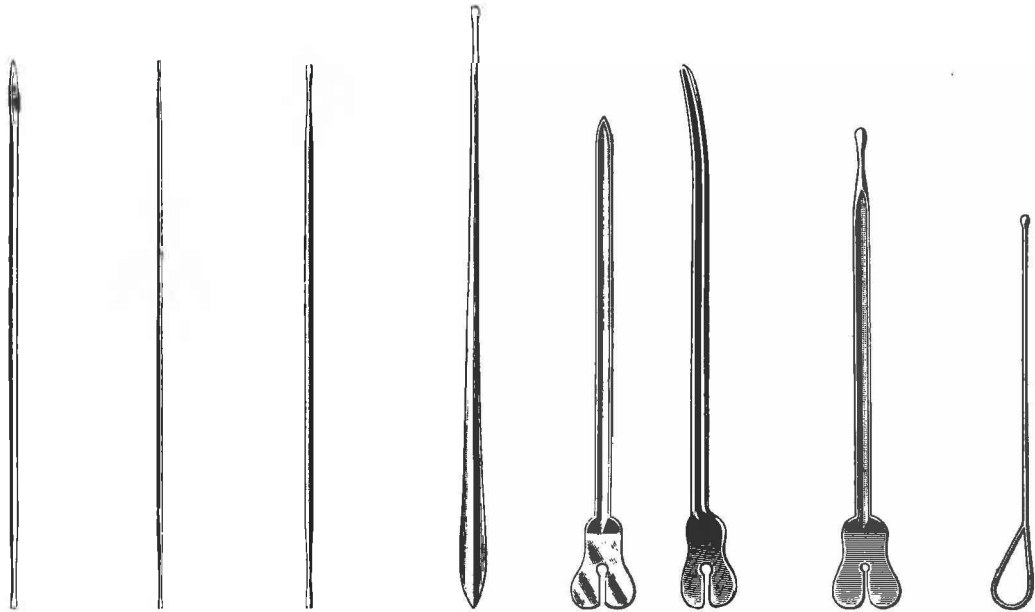

cm	2 mm Ø	1 mm Ø	2 mm Ø		DOYEN	BRODIE	STACKE
10,5							H120-11510
11,5	H120-10211	H120-10411	H120-10611				
13,0	H120-10213	H120-10413	H120-10613		H120-11013		
14,0						H120-11114	
14,5	H120-10214	H120-10414	H120-10614	H120-10814	H120-11014		H120-11214
16,0	H120-10216	H120-10416	H120-10616		H120-11016		H120-11216
18,0	H120-10218	H120-10418	H120-10618		H120-11018		H120-11218
20,0	H120-10220	H120-10420	H120-10620		H120-11020		H120-11220
25,0	H120-10225	H120-10425	H120-10625				

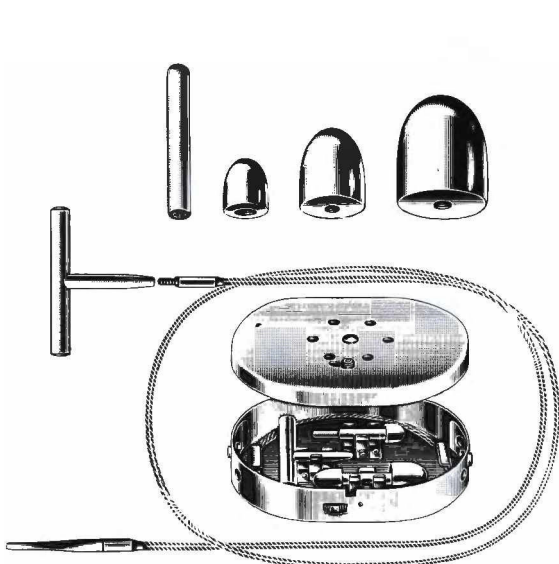

NABATOFF  
H120-15000  
135 X 100 X 25 mm  
compl.

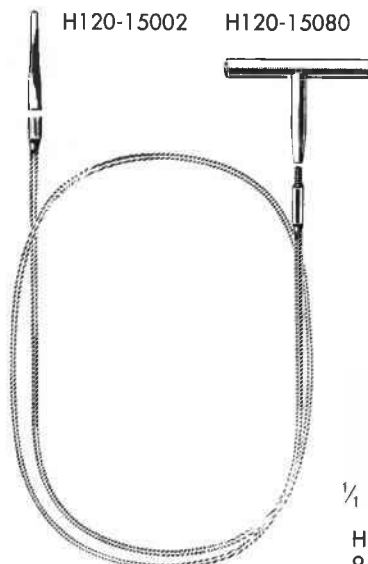

H120-15090



Varizenbesteck  
Varicose vein probe set  
Trousse à varices  
Desobliterador  
Astuccio per varici

Spatel, Watteträger  
Spatulas, Cotton Applicators  
Spatules, porte-coton  
Espátulas, porta-algodón  
Spatole, portacotone

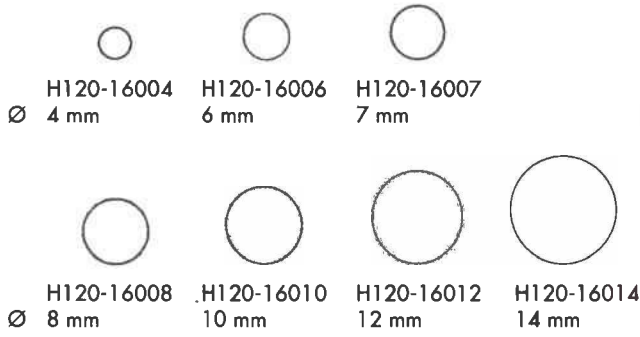

H120-16212  
12 cm

Pflasterspatel  
Plaster spatula  
Spatules  
Espátulas  
Spatole



cm	
13,0	H120-19013
14,5	H120-19014

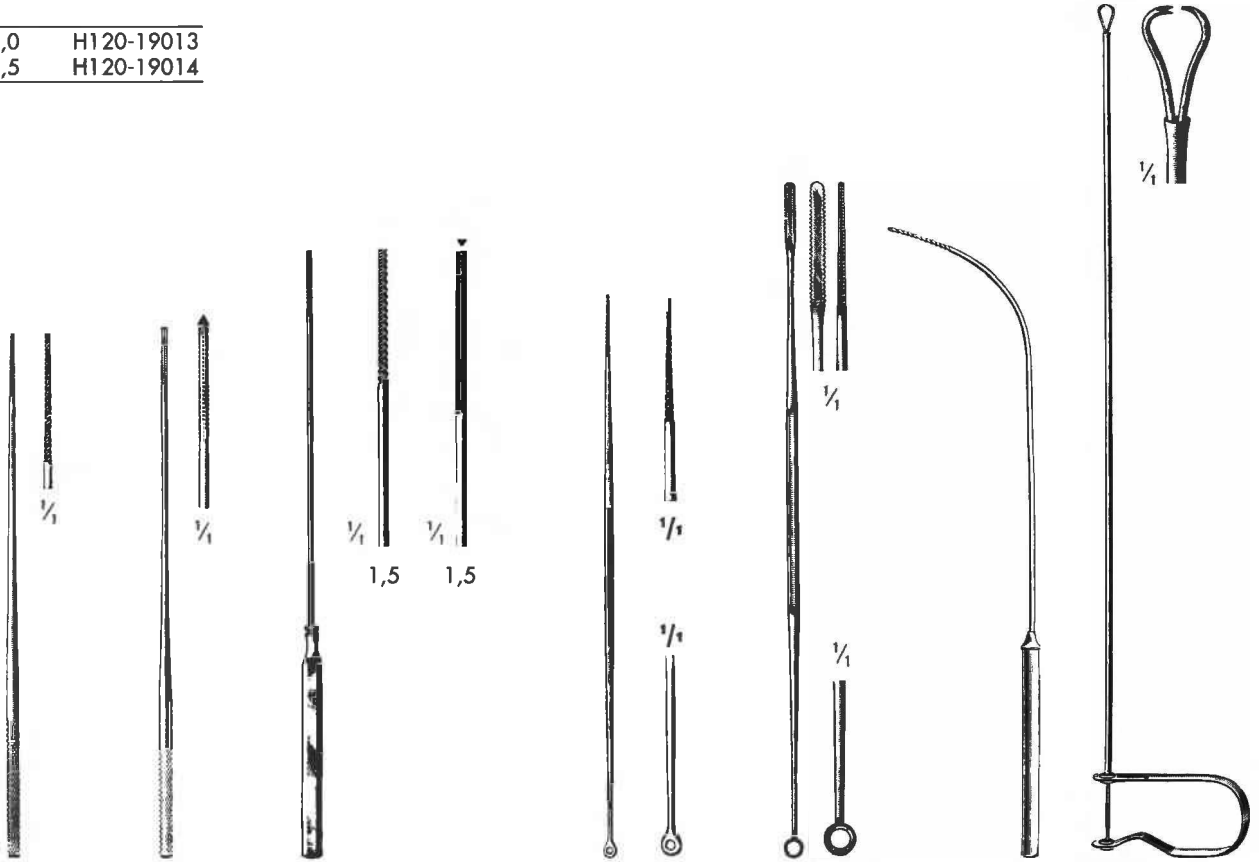

cm	FARRELL	FARRELL	DIMEDA	UCKERMANN	JOBSON-HORNE	TOBOLD
12,0	H120-27012	H120-27212	H120-29012	H120-29212	H120-32012	
14,0	H120-27014	H120-27214	H120-29014	H120-29214		
15,0						H120-31015
16,0			H120-29016	H120-29216		
16,5	H120-27016	H120-27216				
18,0	H120-27018	H120-27218	H120-29018	H120-29218	H120-32018	
23,0	H120-27023	H120-27223				
25,0						H120-33125
45,0						H120-34045

Trokare  
Trocars  
Trocart  
Trócares  
Trequarti

22

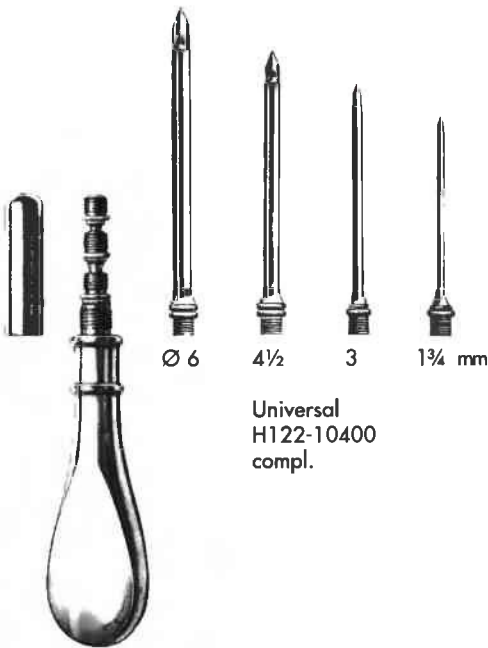

Universal  
H122-10400  
compl.

mm	Standard	Standard	PIERCE
3,0	H122-11030	H122-12030	H122-12330
3,5	H122-11035	H122-12035	
4,0	H122-11040	H122-12040	H122-12340
4,5	H122-11045	H122-12045	
5,0	H122-11050	H122-12050	H122-12350
5,5	H122-11055	H122-12055	
6,0	H122-11060	H122-12060	



DOUGLAS  
H122-12511  
3 mm Ø



FLEURANT  
H122-12723  
23 cm  
5 mm Ø



LICHTWITZ  
H122-12819  
1,75 mm Ø

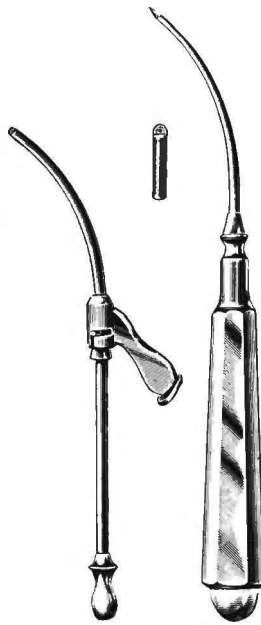

COAKLEY  
H122-14002  
2,25 mm Ø



Charr./  
F. G. OCHSNER

10	H122-15010
12	H122-15012
14	H122-15014
16	H122-15016
18	H122-15018
20	H122-15020



Charr./  
F. G. NELSON

25	H122-17025
30	H122-17030
33	H122-17033
35	H122-17035

Biopsie, Leber, Niere  
Biopsy, Liver, Kidney  
Biopsie, foie, reins  
Biopsia, hígado, riñón  
Biopsia, fegato, rene

Pneumoperitoneum  
Pneumopéritoine  
Neumoperitoneo  
Pneumoperitoneo



H122-21000  
compl.



VERRES  
H122-25020  
2,0 X 100 mm



mm	QUINKE
1,2 X 76	H122-23012
1,2 X 89	H122-23212
1,0 X 76	H122-23010
1,0 X 89	H122-23210
0,7 X 76	H122-23007
0,7 X 89	H122-23207

Pudendus Anesthesie  
anesthesia



mm	MENGHINI	mm	MENGHINI	H122-31214 H122-31218	cc
1,0 X 35	H122-30201	1,4 X 168	H122-31014		5 H122-31405
1,0 X 70	H122-30202	1,8 X 168	H122-31018		10 H122-31410
1,2 X 70	H122-30203				
1,2 X 100	H122-30204				
1,4 X 70	H122-30205				
1,4 X 100	H122-30206				
1,6 X 70	H122-30207				
1,8 X 100	H122-30208				

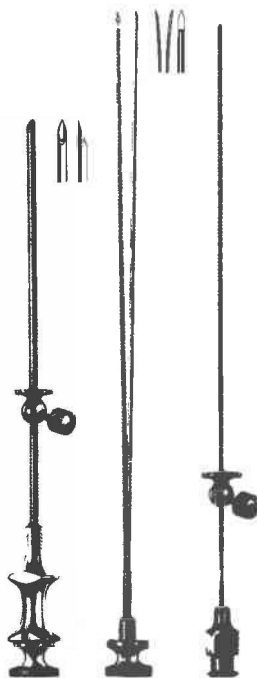

Ø ext. xL.	Ø int. xL.	FRANKLIN-SILVERMANN
mm	mm	
2,0 X 105	1,5 X 155	H122-33020
2,0 X 130	1,5 X 180	H122-33014
compl.		

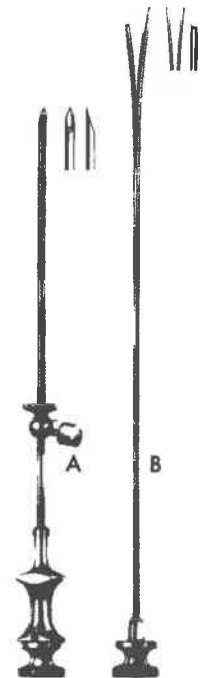

A Ø x L.	B Ø x L.	A + B	B
mm	mm	FRANKLIN-SILVERMANN	
2,0 X 100	1,5 X 150	H122-35020	H122-35215
2,5 X 145	2,0 X 195	H122-35030	H122-35220
2,0 X 100	1,5 X 150	H122-35420	H122-35615
2,5 X 145	2,0 X 195	H122-35425	H122-35620

Nadelhalter  
Needle Holders  
Porte-aiguilles  
Porta-agujas  
Port'aghi

24

Mit TC-Einsätzen  
TC Inserts  
A mors TC  
Con bocas TC  
Con morso TC

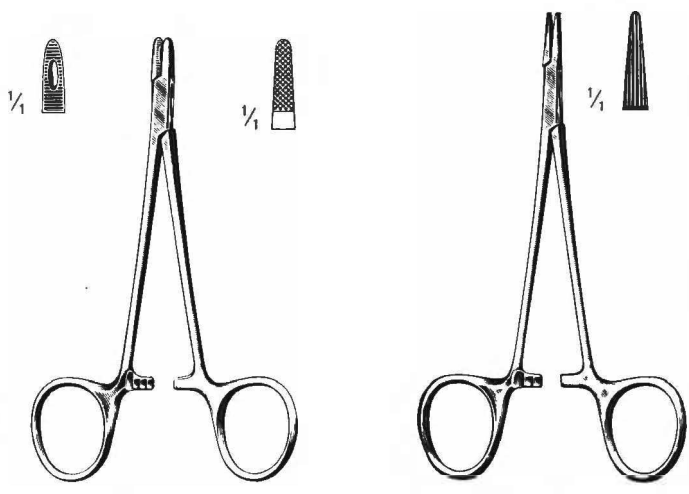

DERF  
H124-11012 12 cm H124-11412

DERF  
H124-12012  
12,5 cm

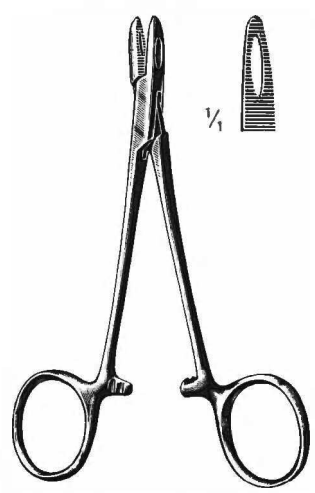

COLLIER  
H124-12212  
12,5 cm

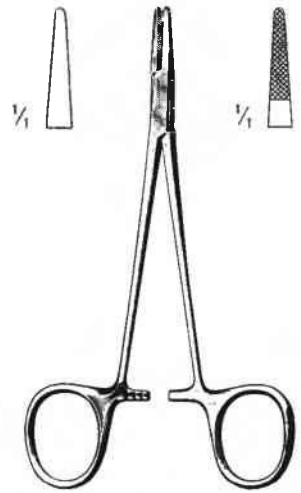

HALSEY  
H124-13013 13 cm H124-14013  
H124-13413 13 cm H124-14413

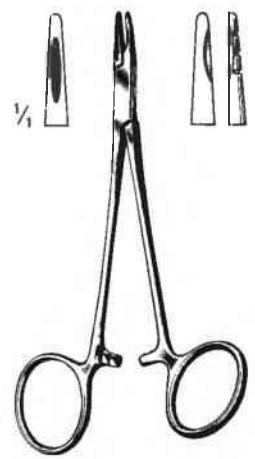

NEIVERT  
H124-14613

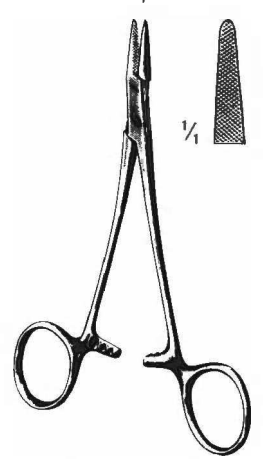

BAUMGARTNER  
H124-15012 12,5 cm H124-15412  
H124-15014 14,0 cm H124-15414

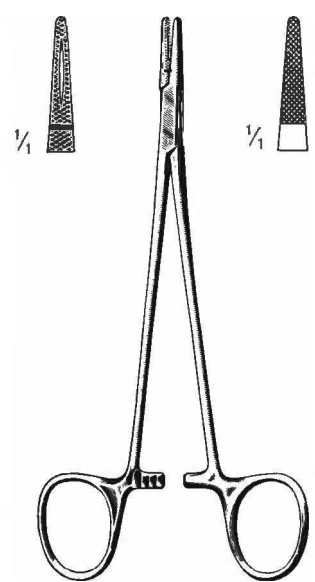

CRILE-WOOD  
H124-16015 15 cm H124-16415  
H124-16018 18 cm H124-16418  
H124-16020 20 cm H124-16420

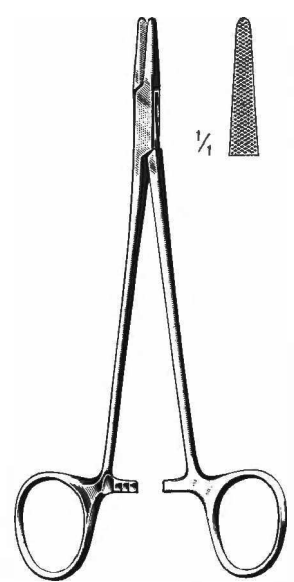

CRILE-MURRAY  
H124-17015 15 cm H124-17415

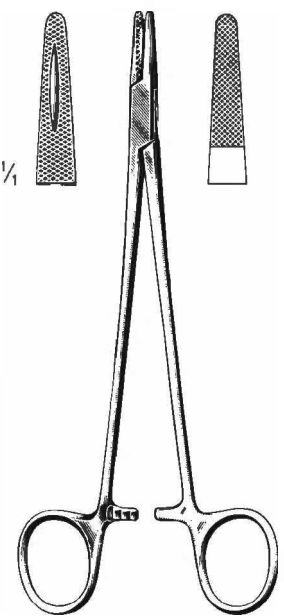

MAYO-HEGAR  
H124-18014 14 cm H124-18414  
H124-18016 16 cm H124-18416  
H124-18018 18 cm H124-18418  
H124-18020 20 cm H124-18420  
H124-18024 24 cm H124-18424  
H124-18026 26 cm H124-18426  
H124-18030 30 cm H124-18430



MAYO-HEGAR  
H124-19016 16 cm H124-19416  
H124-19018 18 cm H124-19418  
H124-19020 20 cm H124-19420



Nadelhalter  
Needle Holders  
Porte-aiguilles  
Porta-agujas  
Port'aghi

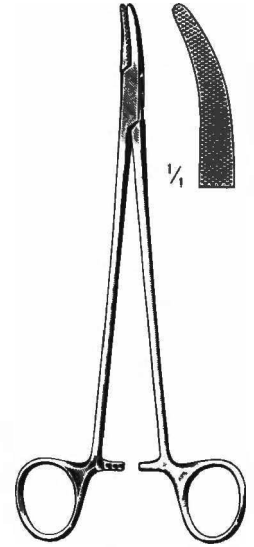
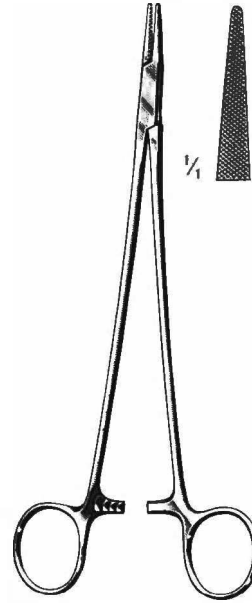
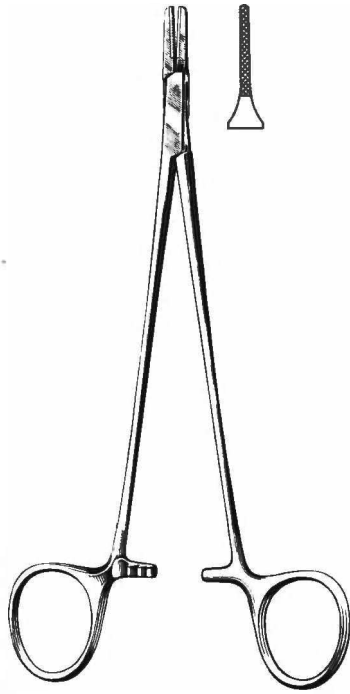
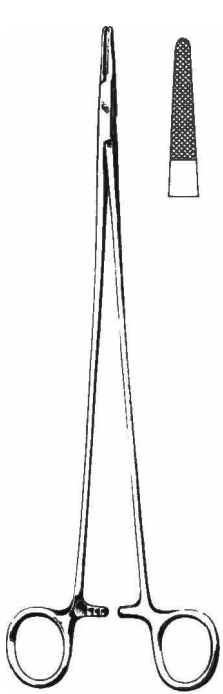

cm	DE BAKEY	RYDER
13		H124-22413
15	H124-21415	H124-22415
18	H124-21418	H124-22418
20	H124-21420	H124-22420
23	H124-21423	H124-22423
26	H124-21426	H124-22426
31	H124-21431	
37	H124-21437	

	JAMISON	HEANEY
H124-23023	23,5 cm	H124-23423
H124-24121	21 cm	H124-24521

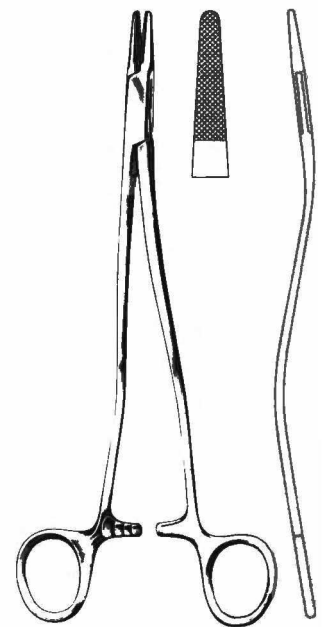
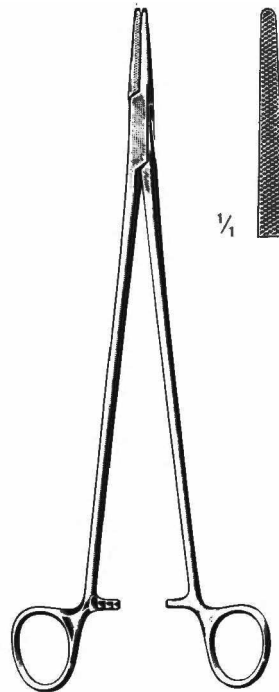
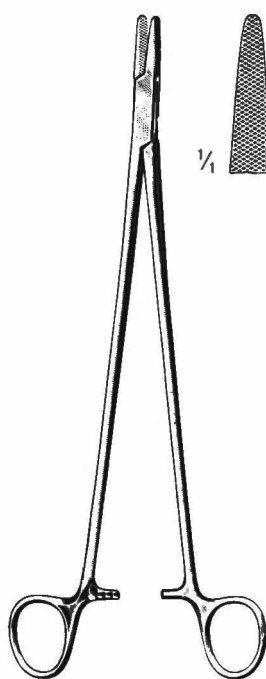
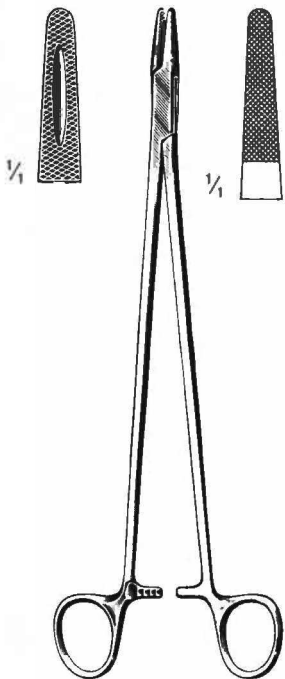

	MASSON	WANGENSTEEN	WANGENSTEEN
H124-25027	27 cm	H124-25427	H124-26027
			27 cm
		H124-26427	H124-27027
			27 cm
			H124-27427

cm	BOZEMANN
20	H124-28520
24	H124-28524
26	H124-28526

Nadelhalter  
Needle Holders  
Porte-aiguilles  
Porta-agujas  
Port'aghi

Mit TC-Einsätzen  
TC Inserts  
A mors TC  
Con bocas TC  
Con morso TC

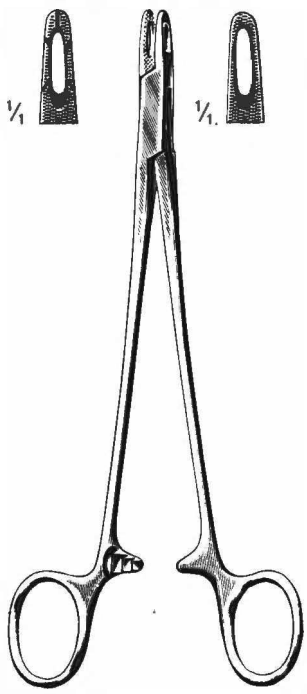

**METZENBAUM**  
H124-29018  
18 cm

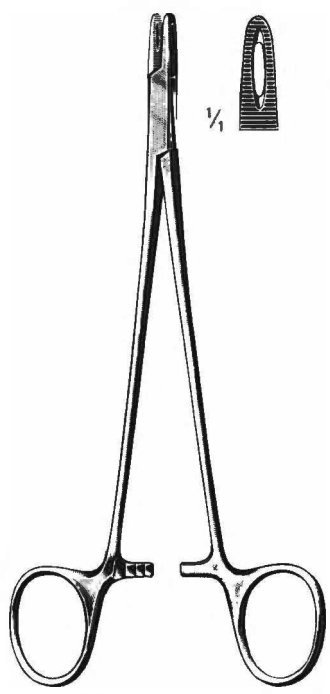

**ADSON**  
H124-29218  
18 cm

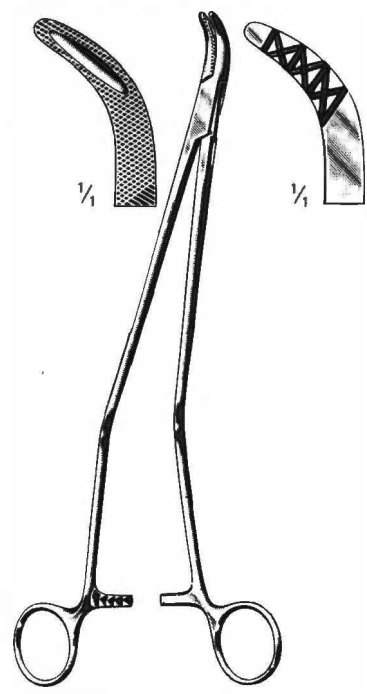

**JOHNSON**  
H124-29327  
27 cm



**FINOCHIETTO**  
H124-31120 20 cm H124-31520  
H124-31127 27 cm H124-31527



**SAROT**  
H124-32018 18 cm H124-32418  
H124-32026 26 cm H124-32426

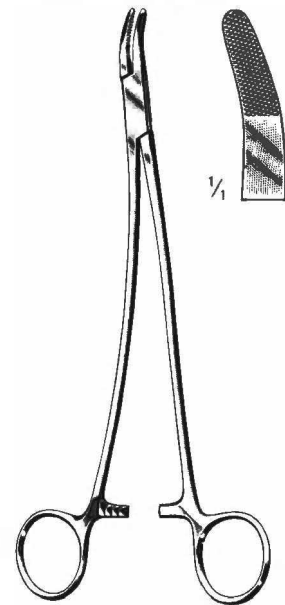

**STRATTE**  
H124-33023 23 cm H124-33423



**CRILE**  
H124-35015  
15 cm



**TOENNIS**  
H124-36018 18 cm H124-36418

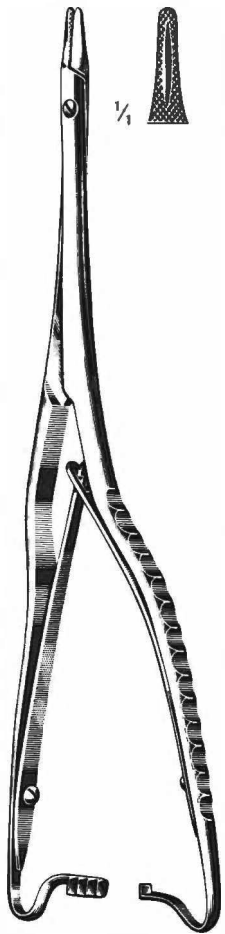

HOESEL  
H124-36725  
25 cm

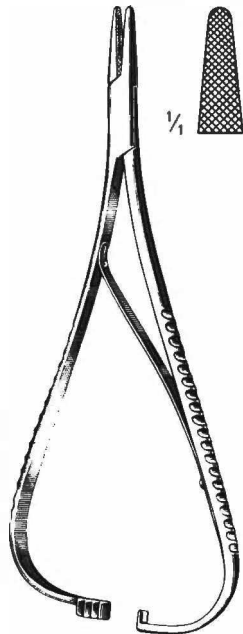

cm	MATHIEU	
14	H124-37014	H124-37414
17	H124-37017	H124-37417
20	H124-37020	H124-37420
24	H124-37024	H124-37424

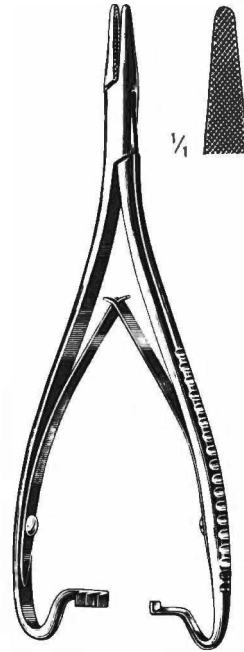

MATHIEU	
H124-38017	H124-38417
H124-38020	H124-38420

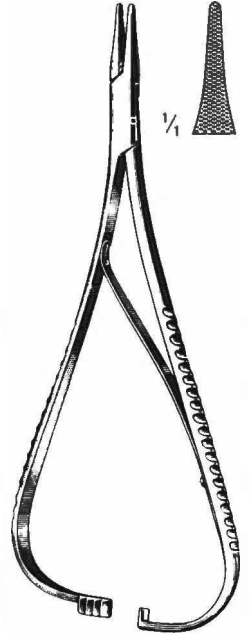

MATHIEU	
H124-39014	H124-39414
H124-39017	H124-39417

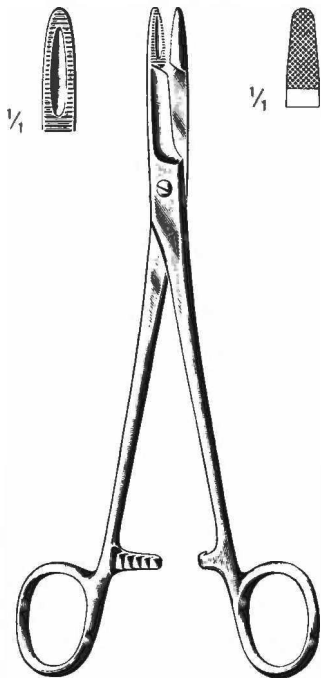

OLSEN-HEGAR			
H124-41014	14 cm	H124-41414	
H124-41018	18 cm	H124-41418	

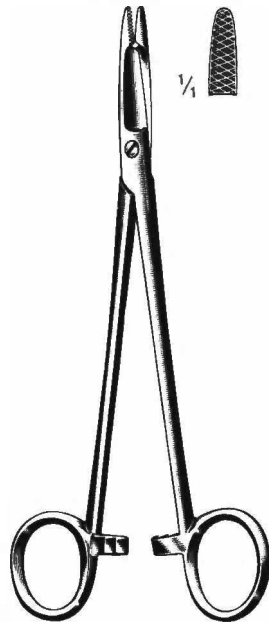

OLSEN-HEGAR			
H124-42017	17 cm	H124-42417	

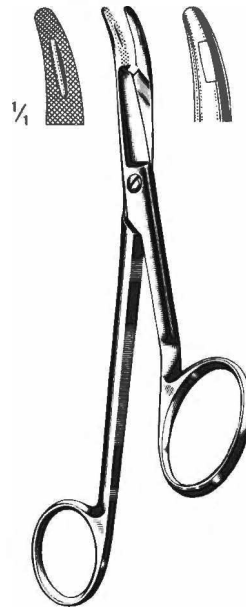

GILLIES			
H124-43016	16 cm	H124-43416	

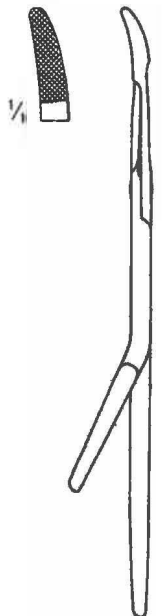

Nadelhalter  
Needle Holders  
Porte-aiguilles  
Porta-agujas  
Port'aghi

Mit TC-Einsätzen  
TC Inserts  
A mors TC  
Con bocas TC  
Con morso TC

Gefäß-Chirurgie  
Vascular surgery  
Chirurgie vasculaire  
Cirugia vascular  
Chirurgia vascolare



cm	DIETRICH
16	H124-44416
18	H124-44418
20	H124-44420
23	H124-44423
26	H124-44426

Ophthalmologie  
Ophthalmology  
Ophtalmologie  
Ofthalmologia  
Ofthalmologia



STEVENS  
H124-61011  
11 cm

cm	STEVENS
13	H124-61213
15	H124-61215

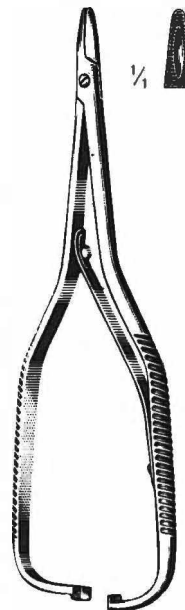

BOYNTON  
H124-61412  
12 cm

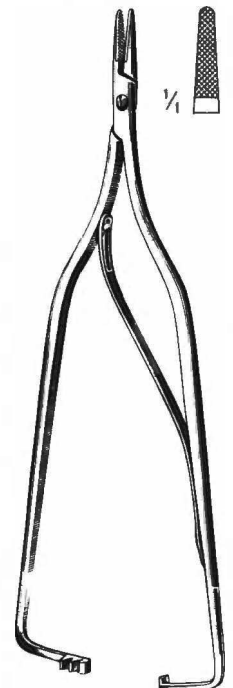

ARRUGA  
H124-62016 16 cm H124-62416

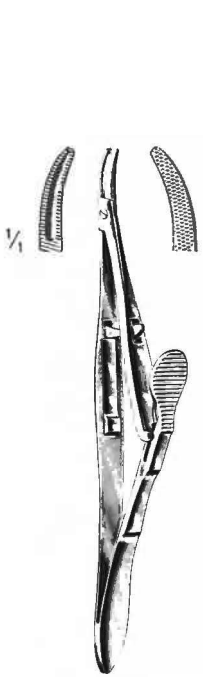

KALT-ARRUGA  
H124-62714  
14 cm

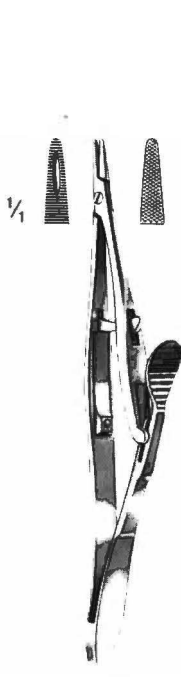

KALT  
H124-62814  
14 cm

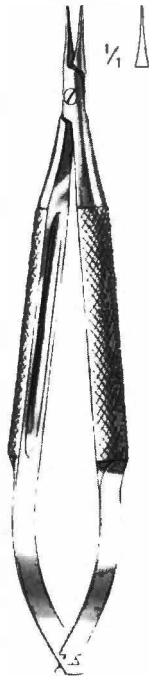

BARRAQUER  
H124-65010  
10 cm

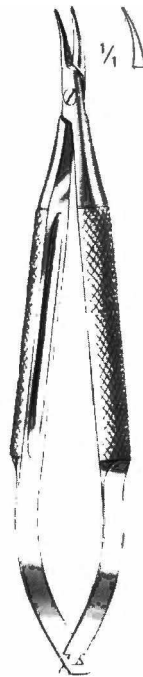

BARRAQUER  
H124-65110  
10 cm

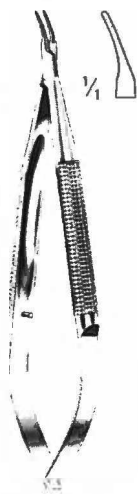

BARRAQUER  
H124-66113 13 cm H124-66513

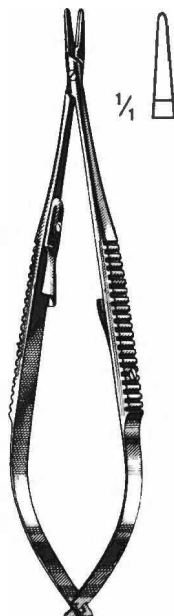

CASTROVIEJO  
H124-67014 14 cm H124-67114  
H124-67414 14 cm H124-67514

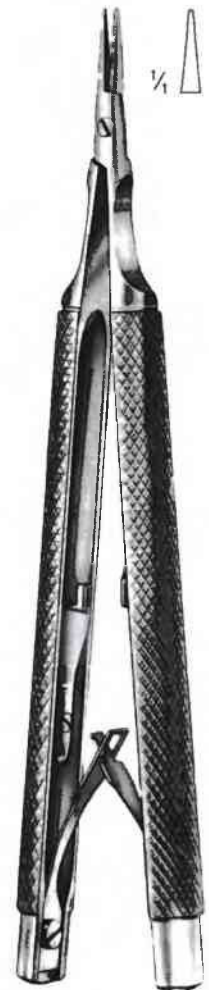
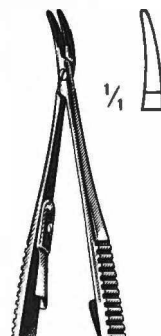

CASTROVIEJO  
H124-68013 13 cm H124-68413



Unterbindungs-nadeln  
Ligature Needles  
Aiguilles à ligatures  
Agujas para ligaduras  
Aghi per legature

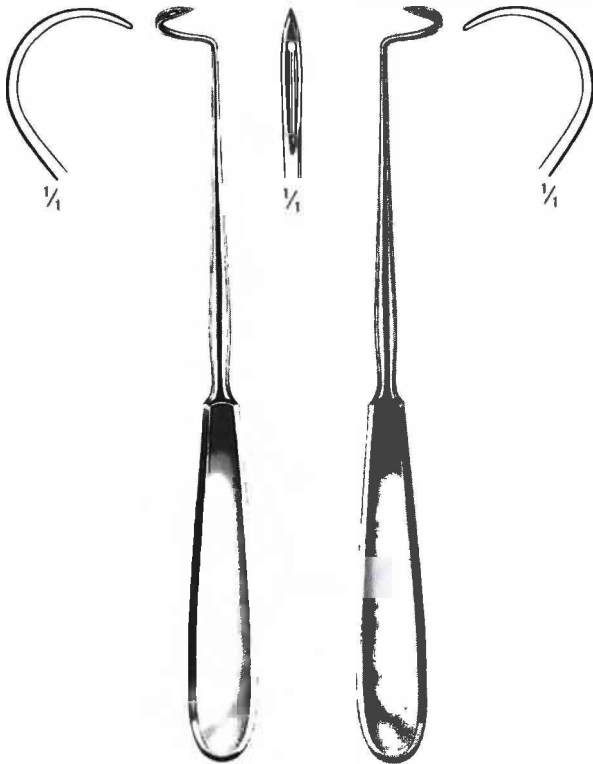

L	DESCHAMPS	R
H126-11021	21 cm	H126-11121
H126-11024	24 cm	H126-11124
H126-11027	27 cm	H126-11127



L	DESCHAMPS	R
H126-12021	21 cm	H126-12121
H126-12024	24 cm	H126-12124
H126-12027	27 cm	H126-12127

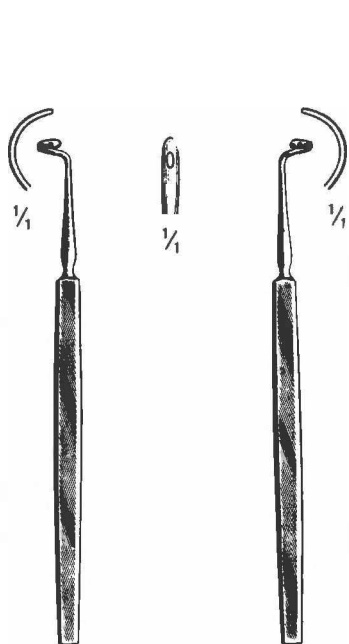

L	KRONECKER	R
H126-13013	13 cm	H126-13113

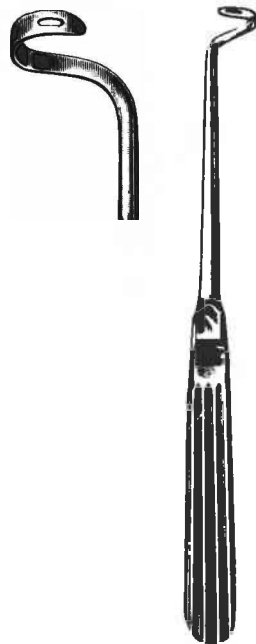

L	NELSON	R
H126-13324	24,5 cm	H126-13524

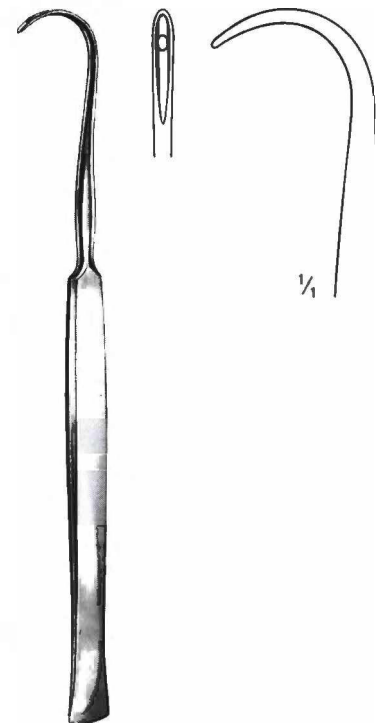

L	COOPER	R
H126-13919	19 cm	

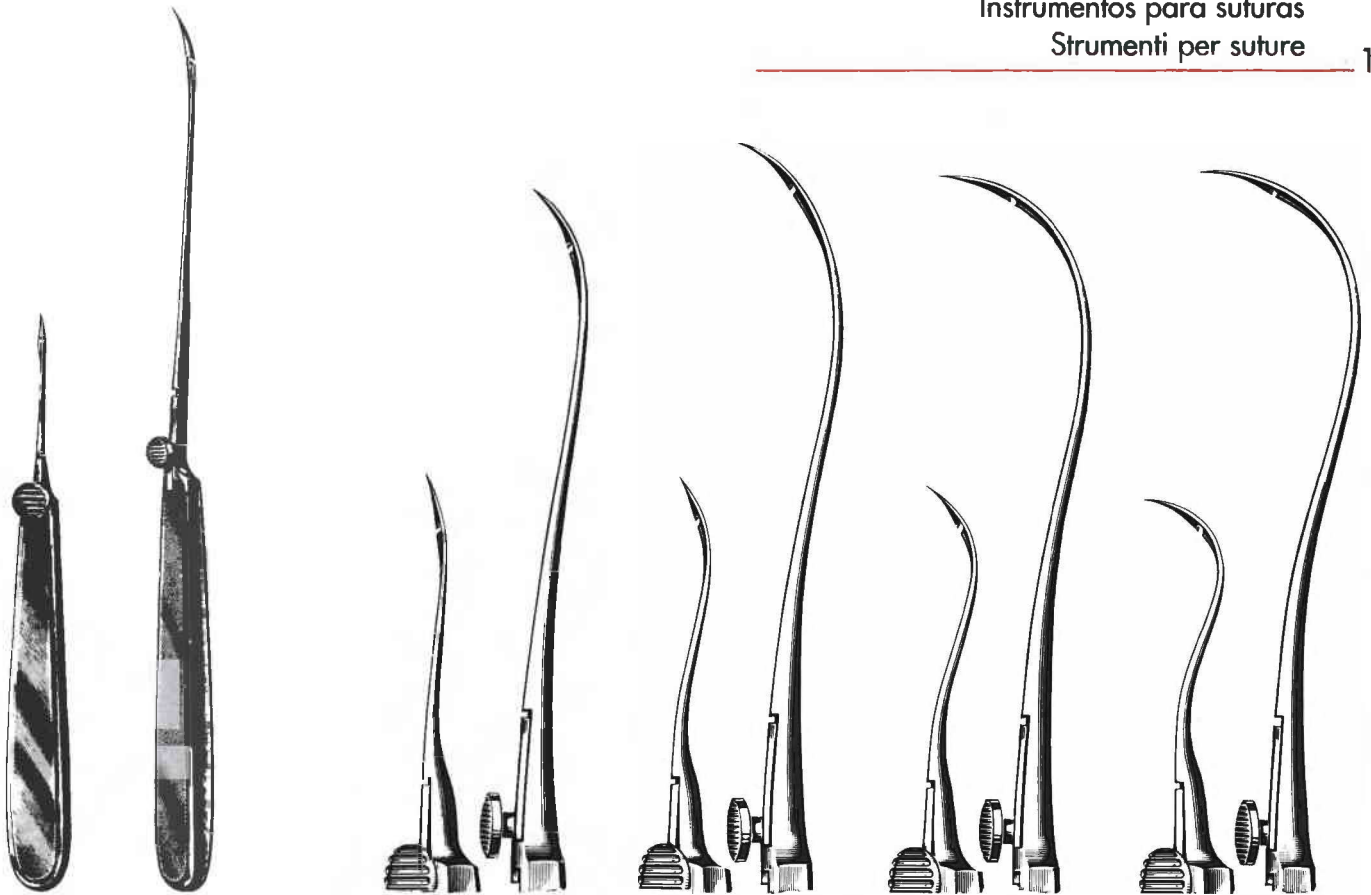

REVERDIN	cm	Fig. 1	Fig. 2	Fig. 3	Fig. 4
H126-20115 - H126-20423	15	H126-20115	H126-20215	H126-20315	H126-20415
	19	H126-20119	H126-20219	H126-20319	H126-20419
	21	H126-20121	H126-20221	H126-20321	H126-20421
	23	H126-20123	H126-20223	H126-20323	H126-20423



TONG boomerang  
H126-24000  
25 cm



Fig. 1  
H126-24001



Fig. 2  
H126-24002

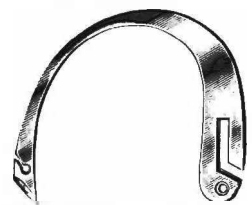
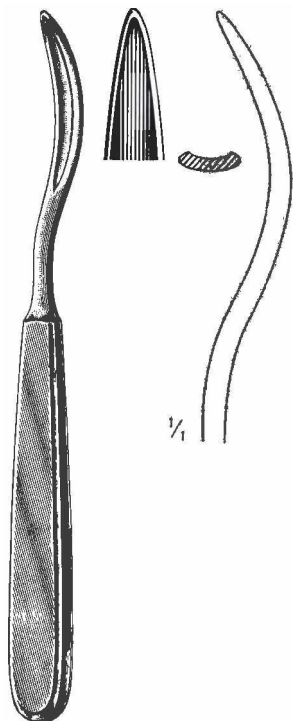

Fig. 3  
H126-24003

Führungs-Hohlsonden  
Ligature Conductors  
Sondes conductrices  
Sondas conductoras  
Sonde conduttrici

26



SCHMIEDEN  
H126-27119  
19 cm

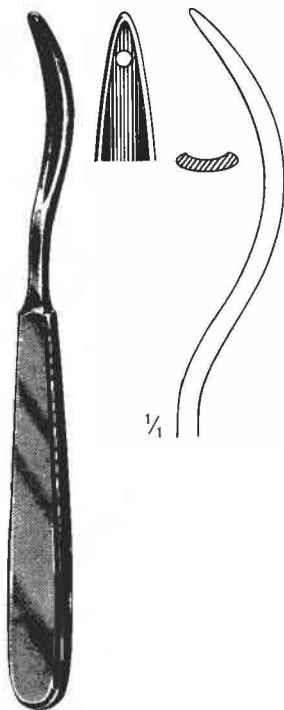

SCHMIEDEN-PAYR  
H126-27319  
19 cm

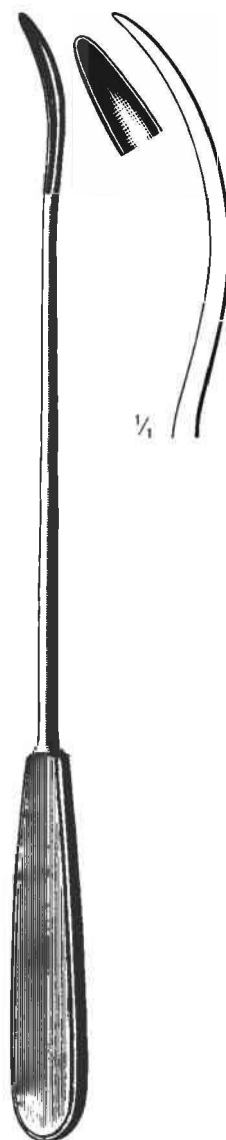

BRUNNER  
H126-27530  
30 cm

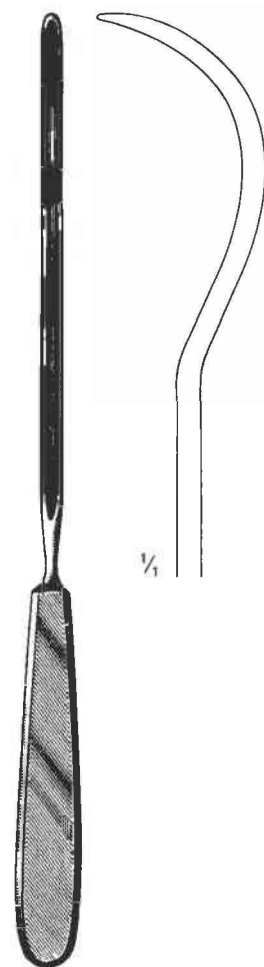

KIRSCHNER  
H126-27725  
25,5 cm

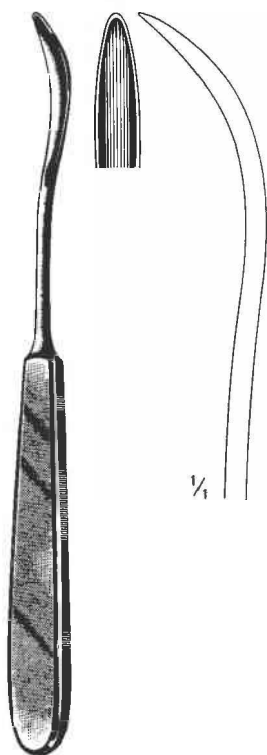

KOENIG  
H126-28520  
20 cm



PAYR  
H126-28822  
22 cm



PAYR  
H126-28922  
22 cm



cm	BRUNNER
18	H126-29118
27	H126-29127

Plastik  
from plastic material  
matière plastique  
de materia plástica  
in plastica



Nähnadeln  
Suturing Needles  
Aiguilles à sutures  
Agujas para suturas  
Aghi per suture

In Packungen zu 1 Dutzend  
In packages of 1 dozen  
En enveloppes de 1 douzaine  
En sobres de 1 dozana  
Bustine di 1 dozzina

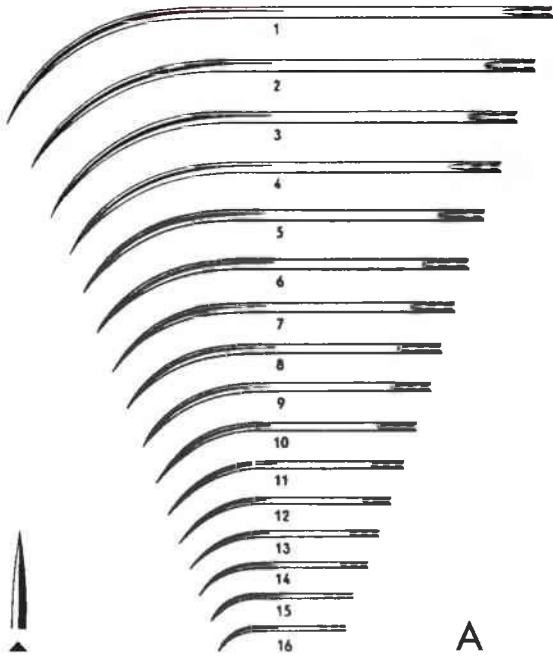

H126-40301 - H126-40316

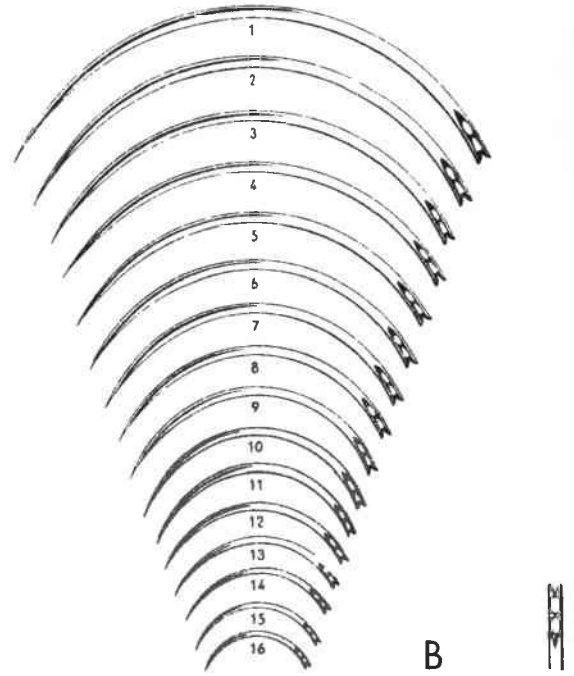

H126-41301 - H126-41316

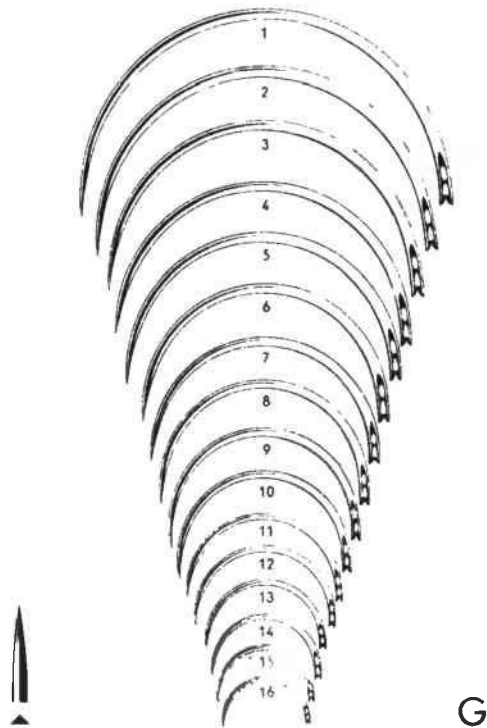

H126-42301 - H126-42316

Alle Nadeln mit Federöhr  
All the needles with spring eye  
Toutes les aiguilles à chas à ressort  
Todas las agujas con ojo de resorte  
Tutti gli aghi con cruna aperta

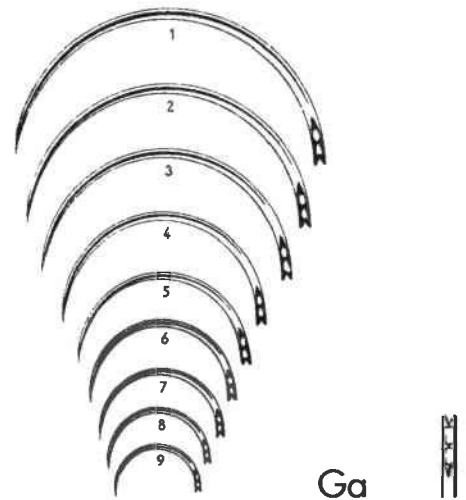

H126-43301 - H126-43309

Fig. 1	2	3	4	5	6	7	8	9	10	11	12	13	14	15	16	
A	H126-40301	H126-40302	H126-40303	H126-40304	H126-40305	H126-40306	H126-40307	H126-40308	H126-40309	H126-40310	H126-40311	H126-40312	H126-40313	H126-40314	H126-40315	H126-40316
B	H126-41301	H126-41302	H126-41303	H126-41304	H126-41305	H126-41306	H126-41307	H126-41308	H126-41309	H126-41310	H126-41311	H126-41312	H126-41313	H126-41314	H126-41315	H126-41316
G	H126-42301	H126-42302	H126-42303	H126-42304	H126-42305	H126-42306	H126-42307	H126-42308	H126-42309	H126-42310	H126-42311	H126-42312	H126-42313	H126-42314	H126-42315	H126-42316
Ga	H126-43301	H126-43302	H126-43303	H126-43304	H126-43305	H126-43306	H126-43307	H126-43308	H126-43309							



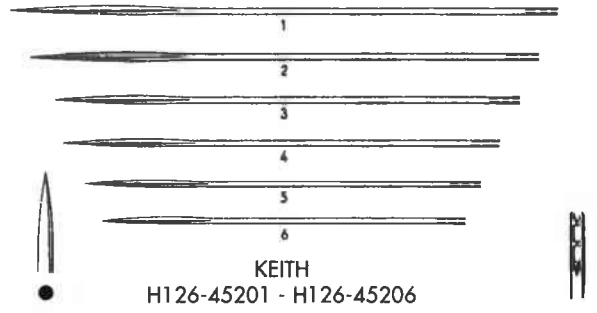
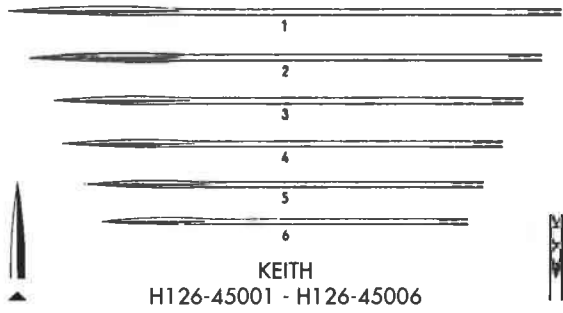
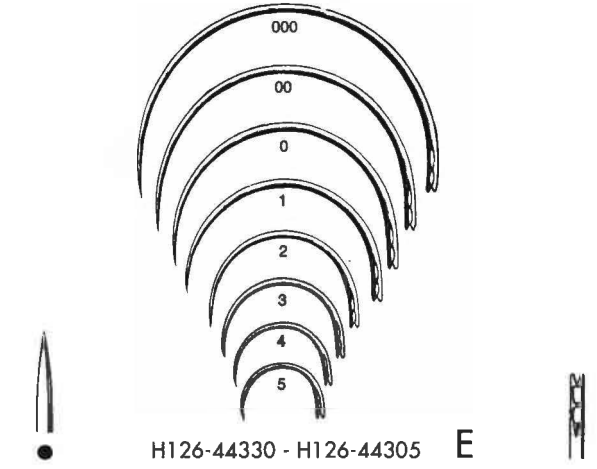
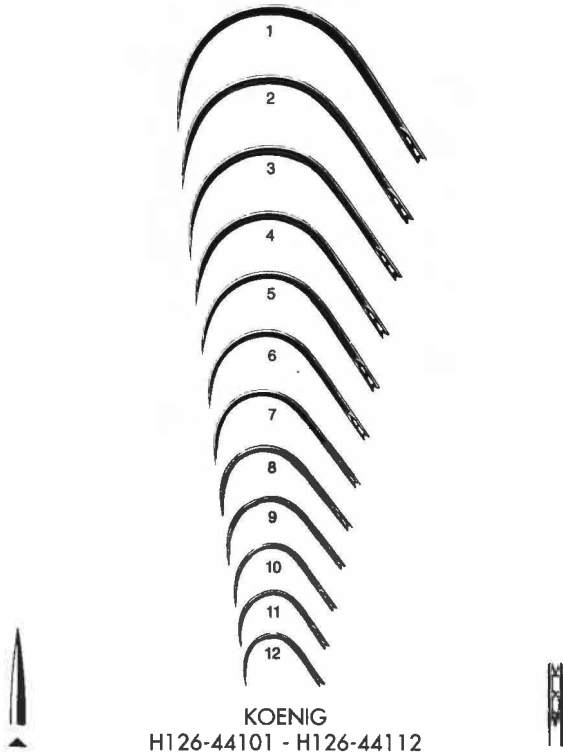

Alle Nadeln mit Federöhr  
All the needles with spring eye  
Toutes les aiguilles à chas à ressort  
Todas las agujas con ojo de resorte  
Tutti gli aghi con cruna aperta

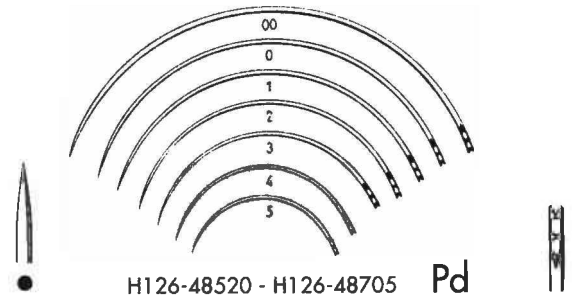
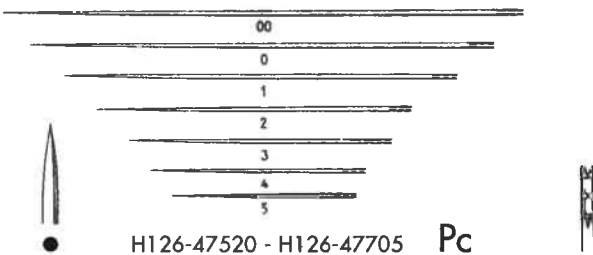
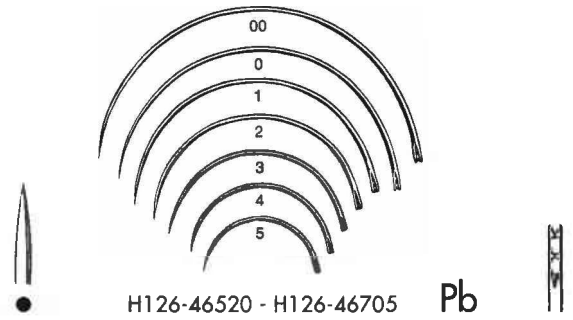

Fig.	000	00	0	1	2	3	4	5	6	7	8	9	10	11	12
KOENIG				H126-44101	H126-44102	H126-44103	H126-44104	H126-44105	H126-44106	H126-44107	H126-44108	H126-44109	H126-44110	H126-44111	H126-44112
E	H126-44330	H126-44320	H126-44310	H126-44301	H126-44302	H126-44303	H126-44304	H126-44305							
KEITH				H126-45001	H126-45002	H126-45003	H126-45004	H126-45005	H126-45006						
KEITH				H126-45201	H126-45202	H126-45203	H126-45204	H126-45205	H126-45206						
Pb	H126-46520	H126-46510	H126-46501	H126-46701	H126-46702	H126-46703	H126-46704	H126-46705							
Pc	H126-47520	H126-47510	H126-47701	H126-47702	H126-47703	H126-47704	H126-47705								
Pd	H126-48520	H126-48510	H126-48701	H126-48702	H126-48703	H126-48704	H126-48705								

Wundklammern, -instrumente  
Clips and Instruments  
Agrafes et instruments  
Agrafes e instrumentos  
Agrafes e strumenti

126



MICHEL  
H126-61012  
12 cm



WACHENFELDT  
H126-61212  
12,5 cm



WACHENFELDT  
H126-61412  
12,5 cm



HEGENBARTH  
H126-61612  
12,5 cm



CHILDE  
H126-62018  
18 cm



MICHEL  
H126-63012  
12 cm



MICHEL  
H126-63113  
13 cm

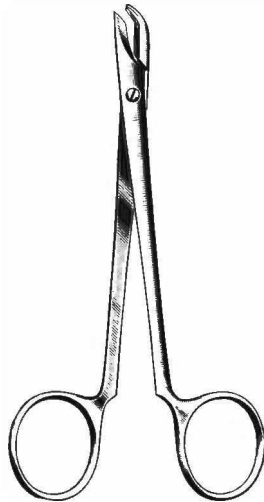

COLLIN  
H126-64013  
13 cm

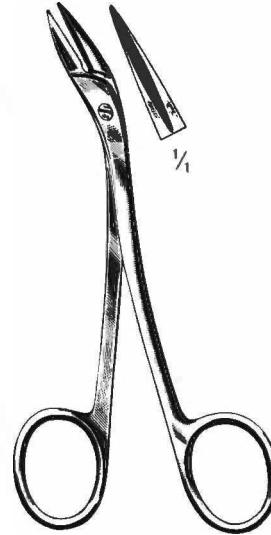

RICHTER-HEATH  
H126-64214  
14 cm

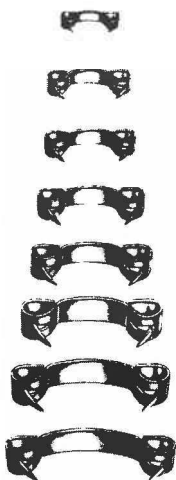

MICHEL

	mm
H126-66007	7,5 X 1,75
H126-66011	11 X 2
H126-66012	12 X 3
H126-66014	14 X 3
H126-66016	16 X 3
H126-66018	18 X 3
H126-66020	20 X 3
H126-66022	22 X 3

Taschen-, Nahtbestecke  
Pocket, Suturing Kits  
Trousses à poche et à suture  
Estuche de bolsillo y de sutura  
Astucci tascabili e per sutura



Standard  
H126-68000  
165 X 90 X 28 mm



H  
1

Sterilisationsinstrumente  
Sterilization Instruments  
Instruments à stérilisation  
Instrumentos para la esterilización  
S



cm DAVIS  
16 H128-10216  
20 H128-10220  
24 H128-10224



CHEATTLE  
H128-11027  
27 cm

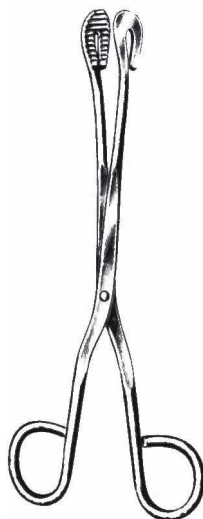

Universal  
H128-12020 20 cm H128-12120  
H128-12028 28 cm H128-12128

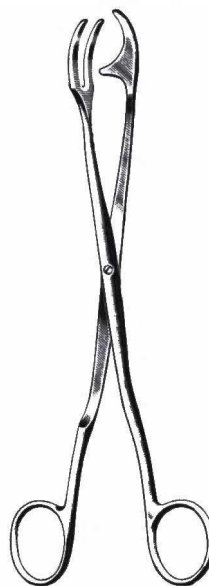

ROGGE  
H128-13023  
23 cm

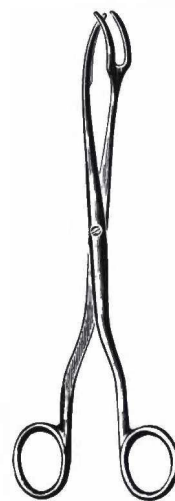

cm  
20 H128-14020  
30 H128-14030



BUNT  
H128-15012  
12 cm

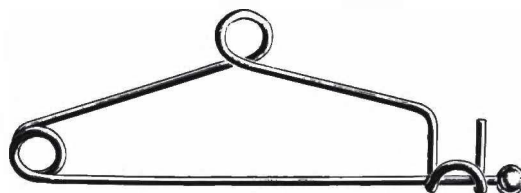

MAYO  
H128-15214  
14 cm

Gipsverband

130

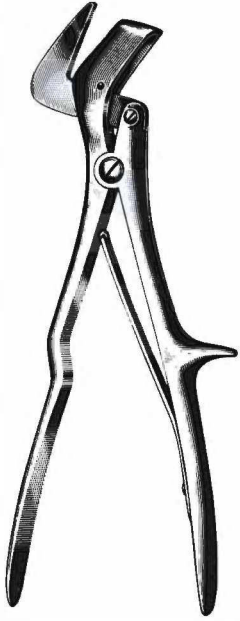

STILLE  
H130-10124  
24 cm



cm	STILLE
23	H130-10323
26	H130-10326
37	H130-10337



WIGMORE  
H130-12019  
19 cm



ENGEL  
H130-13014



BERGMANN  
H130-13418

Elektrische Gipssäge  
Electric Plaster Cast Cutter  
Scie électrique à plâtre  
Sierra eléctrica para yesos  
Sega elettrica per gessi



Volt	
110	H130-21021
220	H130-21022
compl.	

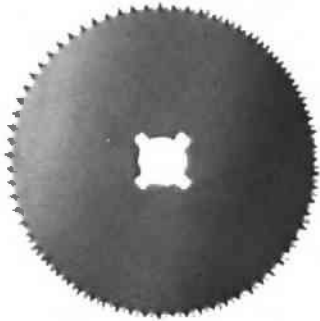

Ø	Typ	
50	H130-21050	normal
50	H130-21150	hart/hard/dure/dura
65	H130-21065	normal
65	H130-21165	hart/hard/dure/dura



H130-21202



Gipsverband  
Plaster of Paris  
Appareils plâtrés  
Vendajes enyesados

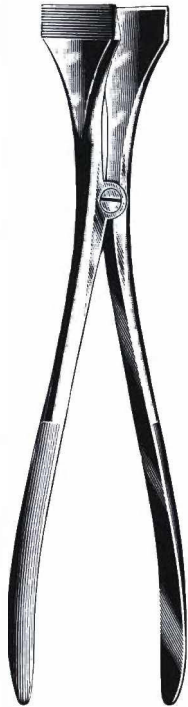

HENNIG  
H130-35028  
28 cm



BEESON  
H130-36030  
30 cm



HAGLUND-STILLE  
H130-36228  
28 cm



H130-36623  
23 cm



HOPKINS  
H130-37020  
20 cm



ESMARCH  
H130-38018  
18 cm



REINER  
H130-39018  
18 cm

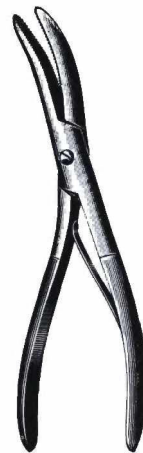

WOLFF  
H130-39518  
18 cm



WOLFF  
H130-39724  
24 cm

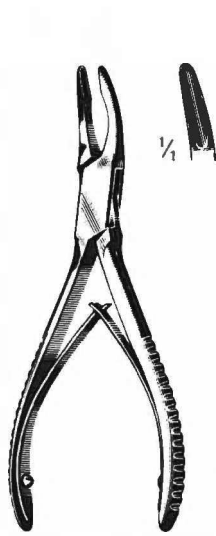

FRIEDMAN mini  
H132-10112  
12 cm

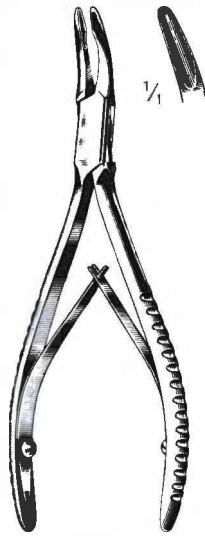

FRIEDMAN  
H132-10114  
14 cm



FRIEDMAN  
H132-10214  
14 cm

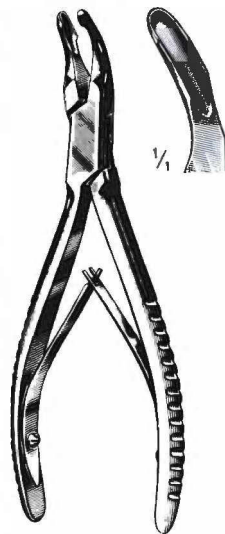

CLEVELAND  
H132-10314  
14 cm

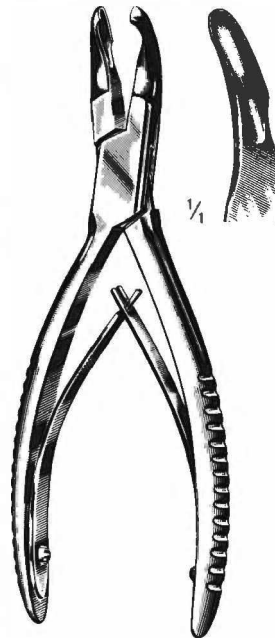

CLEVELAND  
H132-10517  
17 cm

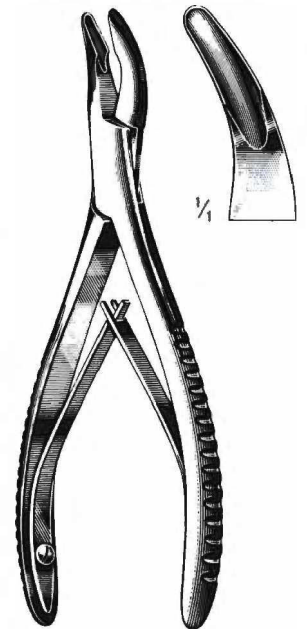

MEAD  
H132-10716  
16,5 cm

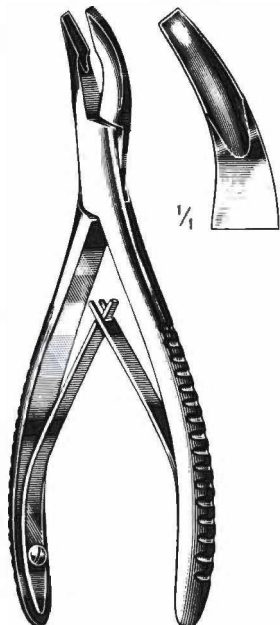

MEAD  
H132-10916  
16,5 cm

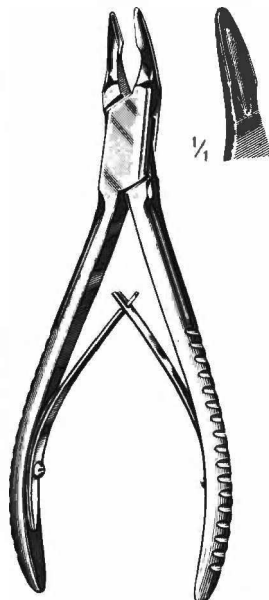

BLUMENTHAL  
H132-11515  
15,5 cm

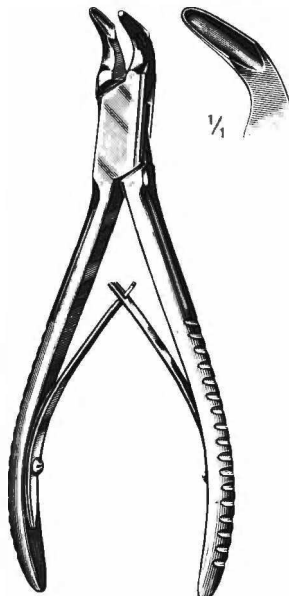

BLUMENTHAL  
H132-11715  
15,5 cm

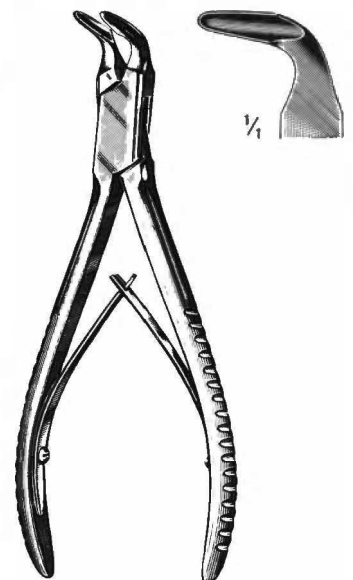

BLUMENTHAL  
H132-11915  
15,5 cm

Hohlmeißelzangen  
Bone Rongeurs  
Pincés-gouges  
Pinzas-gubias  
Pinze saorbie

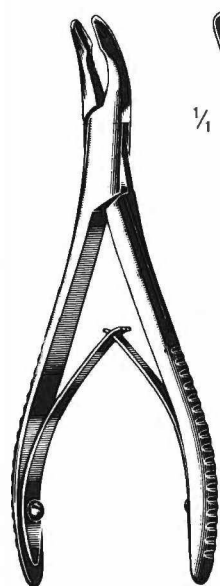

LUER  
H132-13115  
15 cm

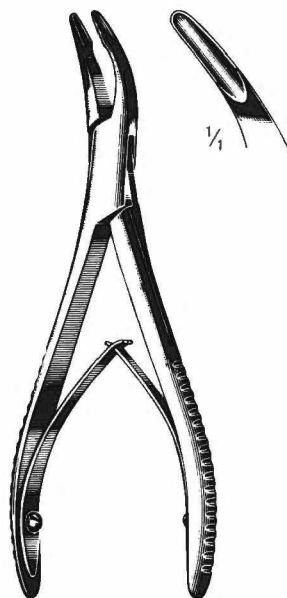

LUER  
H132-13315  
15 cm

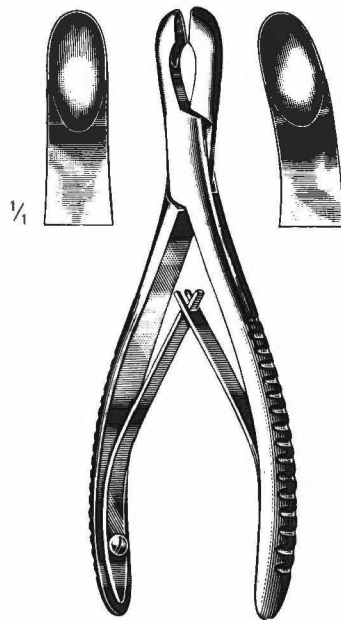

LUER  
H132-13617 17 cm H132-13717

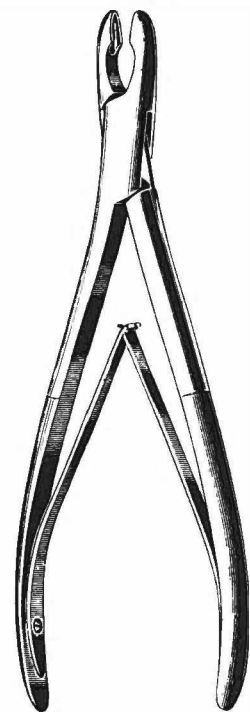

ADSON  
H132-14220 20 cm H132-14320

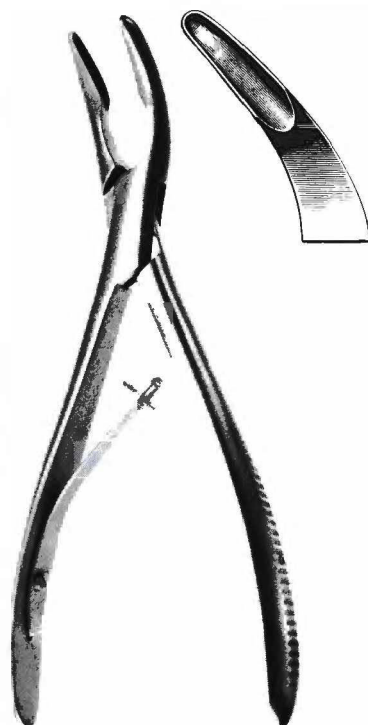

OLIVECRONA  
H132-14720  
20 cm

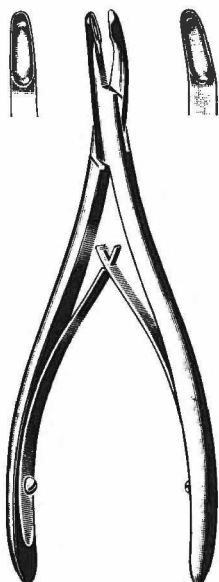

LEMPERT  
H132-15016 16 cm H132-15116

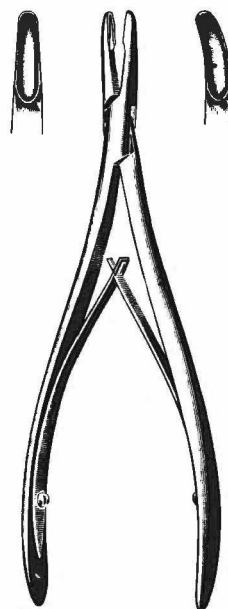

LEMPERT  
H132-15418 18,5 cm H132-15518



Hohlmeißelzangen  
Bone Rongeurs  
Pincès-gouges  
Pinzas-gubias  
Pinze sgorbie

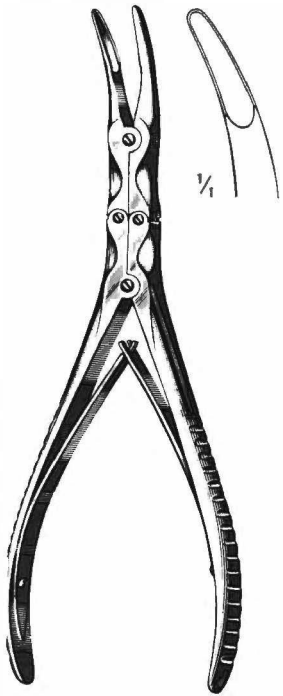

BEYER  
H132-20118  
18 cm

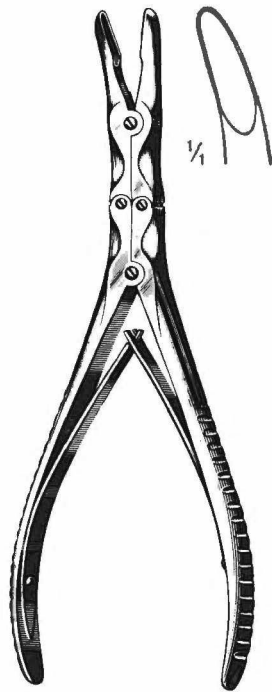

ZAUFAL-JANSEN  
H132-20518  
18 cm



BOHLER  
H132-21115 15 cm H132-21315  
18 cm

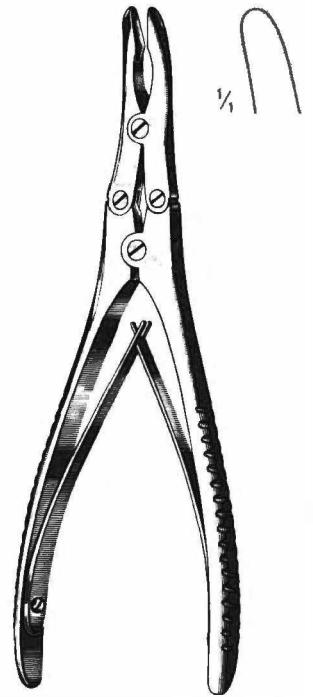

RUSKIN  
H132-21618 18 cm H132-21718  
18 cm

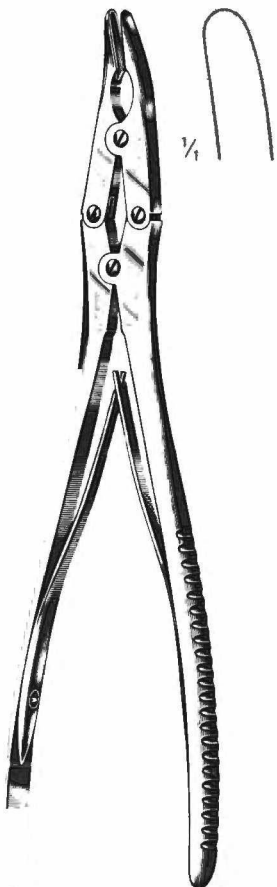

RUSKIN  
H132-21923  
23 cm

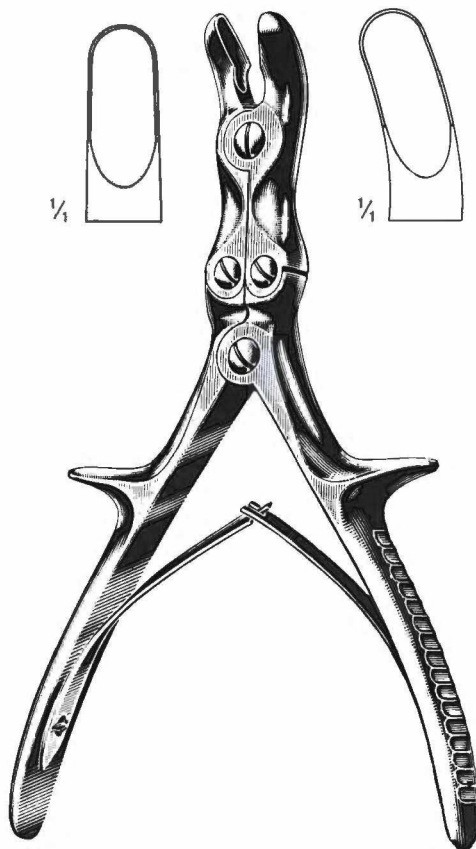

STILLE-LUER  
H132-23022 22 cm H132-23122  
H132-23026 26 cm H132-23126  
26 cm

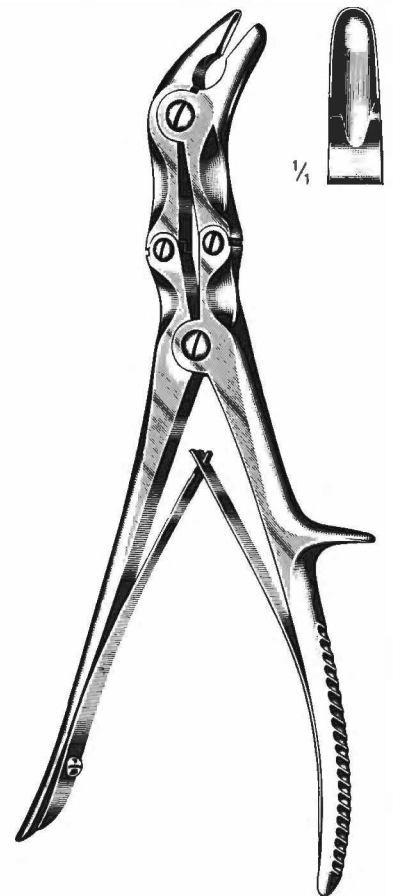

STILLE-LUER  
H132-23523  
23 cm

Hohlmeißelzangen  
Bone Rongeurs  
Pincés-gouges  
Pinzas-gubias  
Pinze sgorbie

32

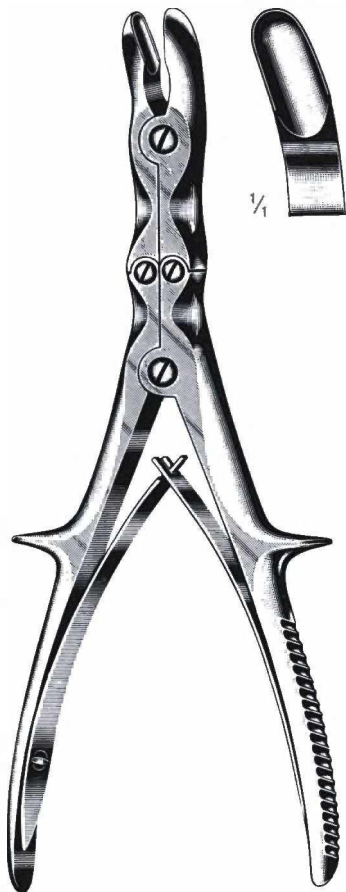

STILLE-RUSKIN  
H132-23723  
23 cm

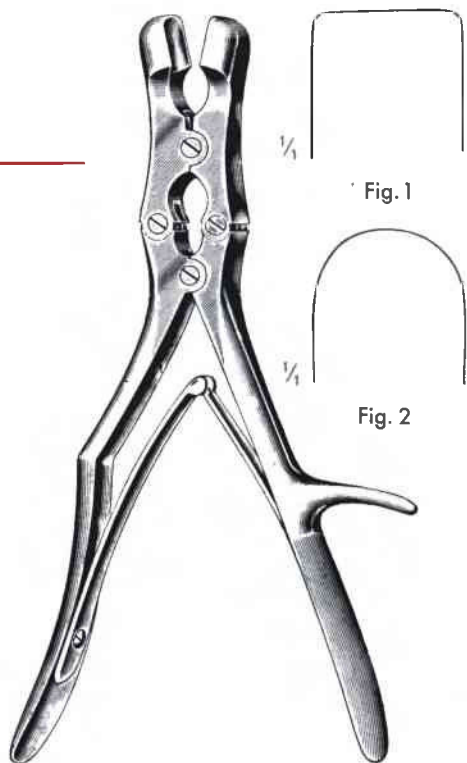

Fig. SAUERBRUCH  
1 H132-24130  
2 H132-24330  
30 cm



Fig. LEKSELL (STILLE)  
1 H132-24523  
2 H132-24723  
23 cm



R SCAGLIETTI L  
H132-25126 26 cm H132-25326  
à droite à gauche  
derecha izquierda  
a destra a sinistra



FRYKHOLM  
H132-25524  
24 cm



23 cm



Knochensplitterzangen  
Bone Cutting Forceps  
Pinzas cortantes para huesos  
Cesoie per ossa

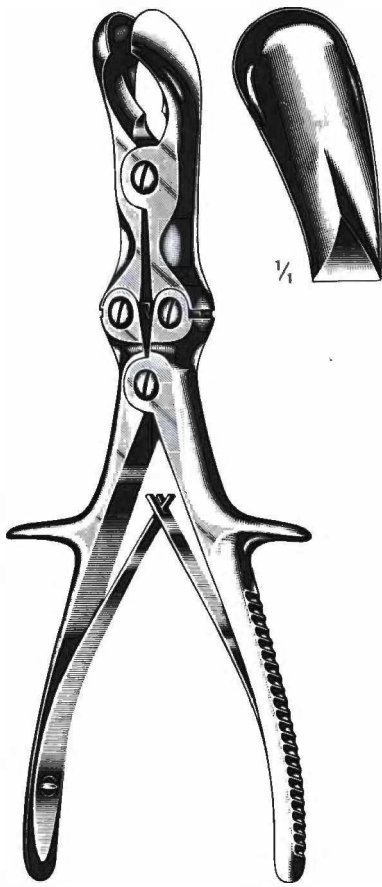

SEMB  
H132-26122  
22,5 cm

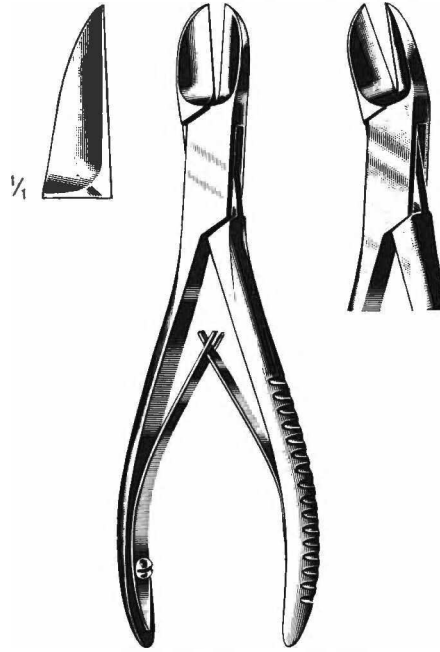

LISTON  
H132-27414 14 cm H132-27514  
H132-27417 17 cm H132-27517  
H132-27419 19 cm H132-27519  
H132-27422 22 cm H132-27522



BÖHLER  
H132-28015 15 cm H132-28115

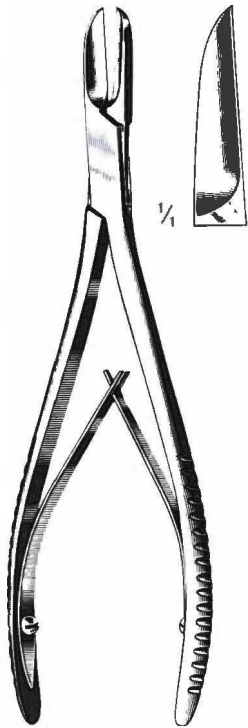

COTTLE-KAZANJIAN  
H132-28219  
19 cm

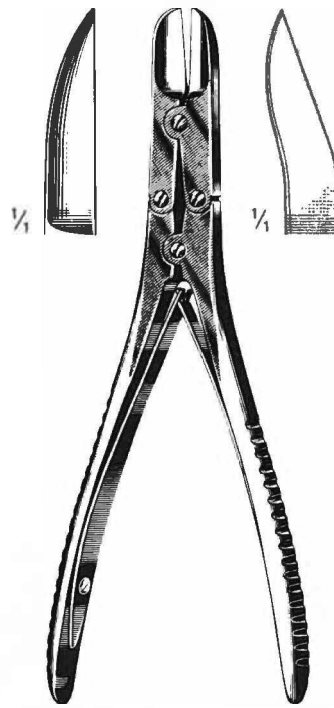

RUSKIN-LISTON  
H132-28618 18,5 cm H132-28918

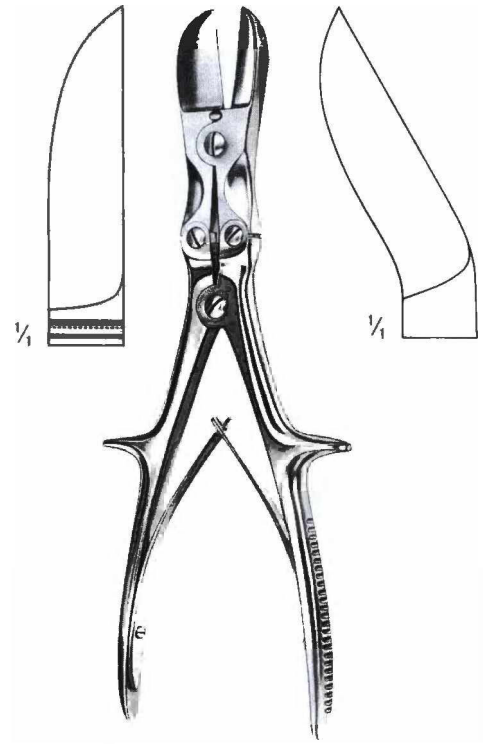

STILLE-LISTON  
H132-29027 27 cm H132-29127

Knochensplitterzangen  
Bone Cutting Forceps  
Pincés coupantes à os  
Pinzas cortantes para huesos  
Cesoie per ossa

32



STILLE-HORSLEY  
H132-29327  
27 cm

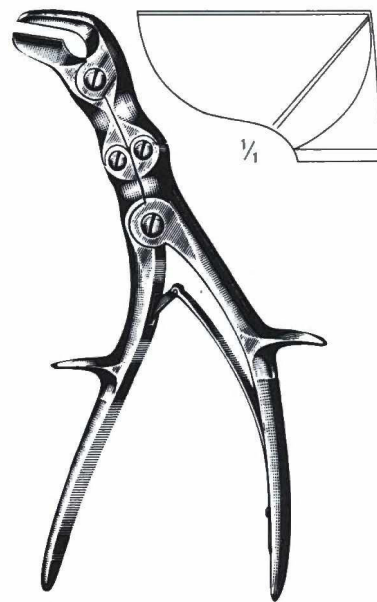

SEMB  
H132-29524  
24 cm

Knochenhalte-zangen  
Bone Holding Forceps  
Daviers porte-os  
Pinzas para huesos  
Tenaglie per ossa

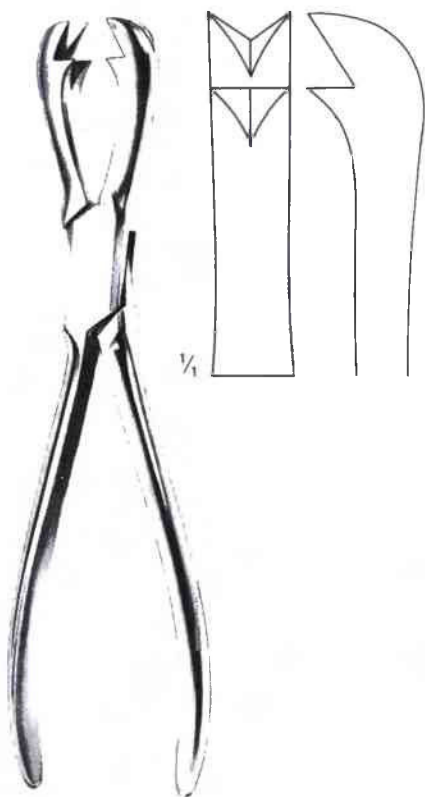

FERGUSSON  
H132-36021  
21 cm

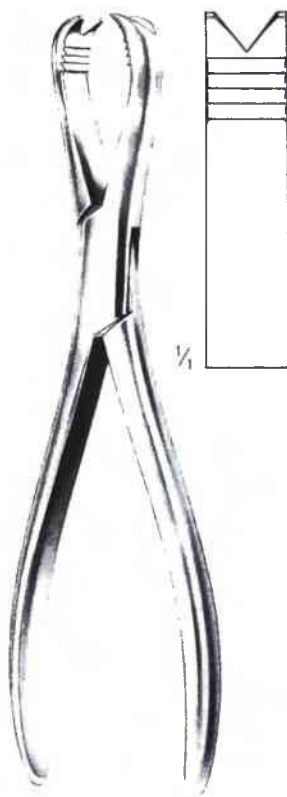

LANGENBECK  
H132-36221  
21 cm

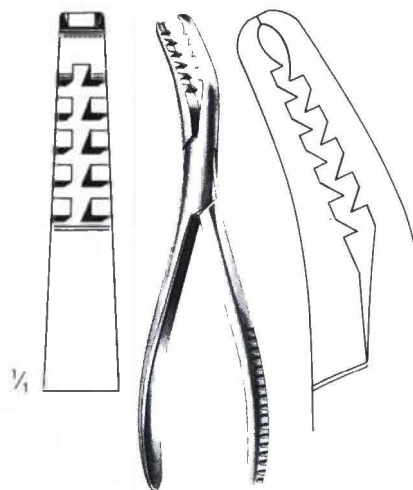

SEMB  
H132-36519  
19 cm



cm	FARABEU
23	H132-36623
26	H132-36626

Knochenhalte­zangen  
Bone Holding Forceps  
Daviers porte-os  
Pinzas para huesos  
Tenaglie per ossa



FARABEU­F-LAMBOTTE  
H132-36826  
26 cm



cm	LAMBOTTE
22	H132-37022
27	H132-37027
30	H132-37030



cm	LAMBOTTE
22	H132-37222
26	H132-37226
33	H132-37233



cm	LAMBOTTE
19	H132-37319
23	H132-37323
26	H132-37326

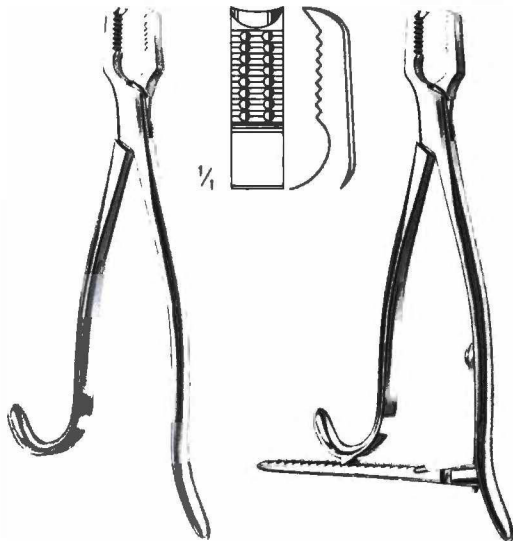

cm	KERN	KERN
15	H132-37815	H132-38015
17	H132-37817	H132-38017
21	H132-37821	H132-38021

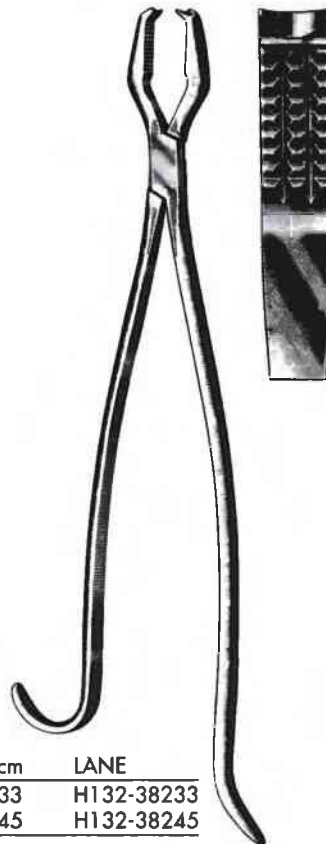

cm	LANE
33	H132-38233
45	H132-38245

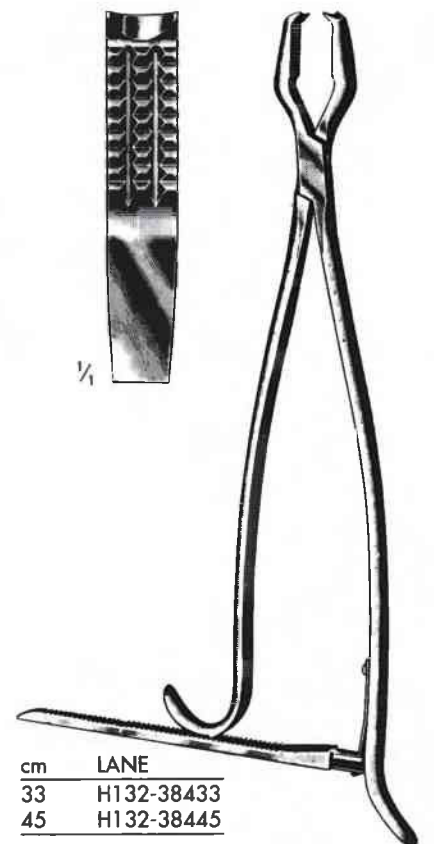

cm	LANE
33	H132-38433
45	H132-38445

Knochenhalte­zangen  
Bone Holding Forceps  
Daviers porte-os  
Pinzas para huesos  
Tenaglie per ossa

132



H132-39115 - H132-39128

Selbstzentrierend  
self-centering  
autocentrant  
autocentrantes  
autocentranti



H132-39115  
15 cm

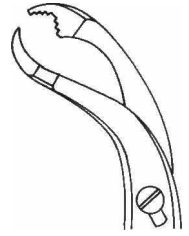

H132-39119  
19 cm

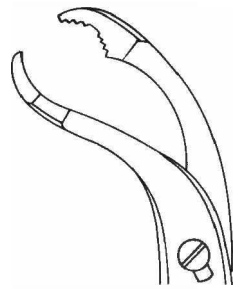

H132-39124  
24 cm

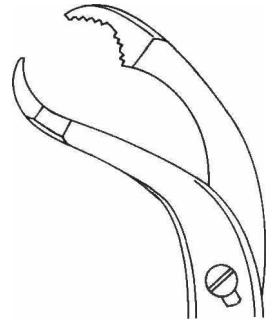

H132-39126  
26 cm

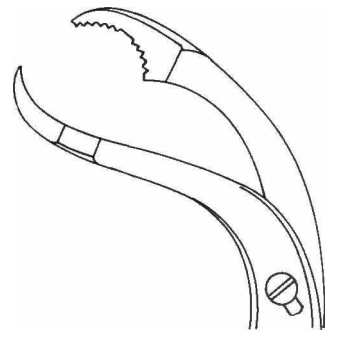

H132-39128  
28 cm



VERBRUGGE  
H132-39517 - H132-39527

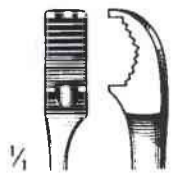

H132-39517  
17,5 cm

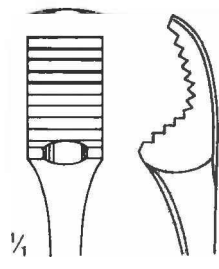

H132-39525  
25 cm

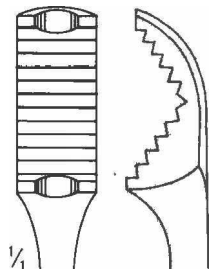

H132-39526  
26 cm

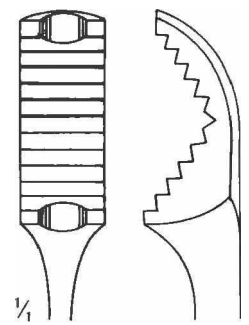

H132-39527  
27 cm



Knochenhalte-, Sequesterzangen  
Bone Holding, Sequester Forceps  
Pinces à os, à séquestres  
Pinzas para huesos y sequestros  
Pinze per ossa e sequestri

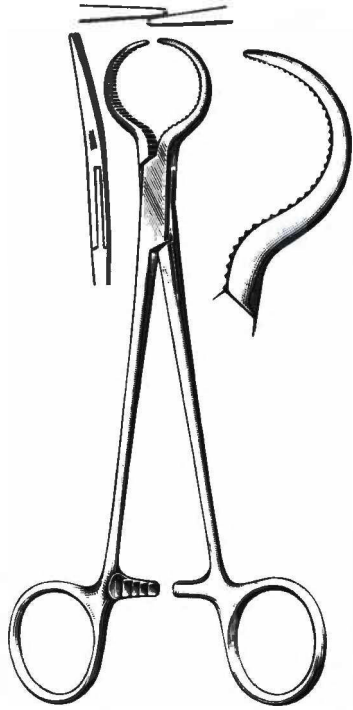

LEWIN  
H132-40217  
17,5 cm



BIRCHER-GANSKE  
H132-40420 20 cm H132-40520



DINGMANN  
H132-40719  
19 cm



H132-40913  
13,5 cm



MARTIN  
H132-41019  
19 cm

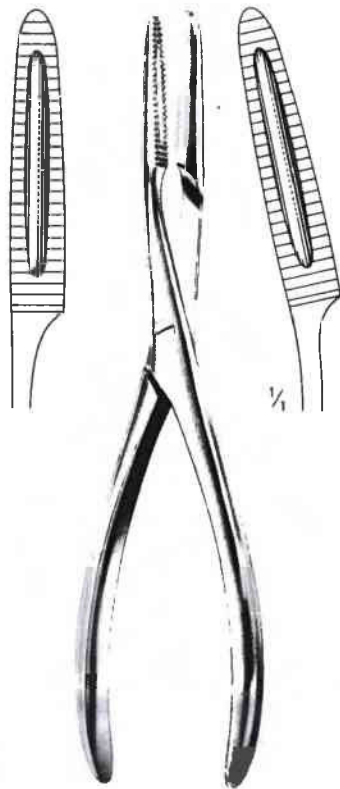

H132-42020 20 cm H132-42120

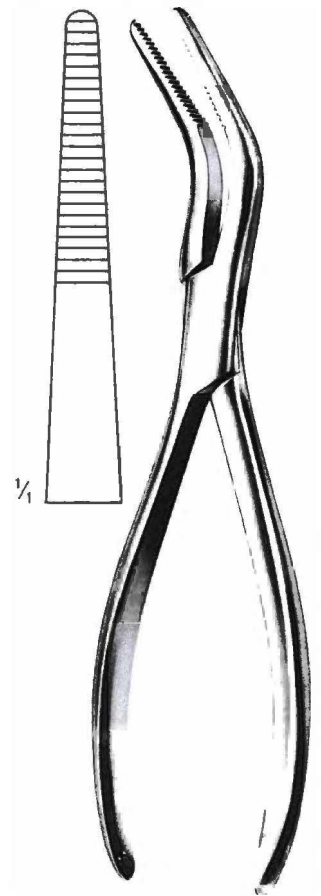

VAN BUREN  
H132-42323  
23 cm



Knochenchirurgie  
Bone Surgery  
Chirurgie osseuse  
Cirugía ósea  
Chirurgia ossea

132

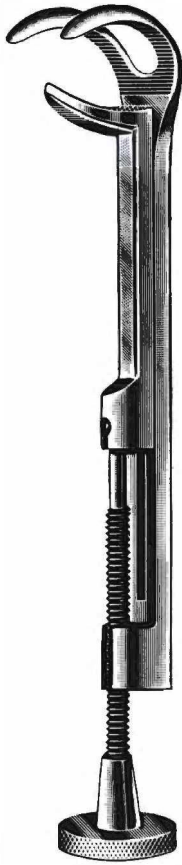

cm	LOWMAN
13	H132-44113
18,5	H132-44118
20	H132-44120

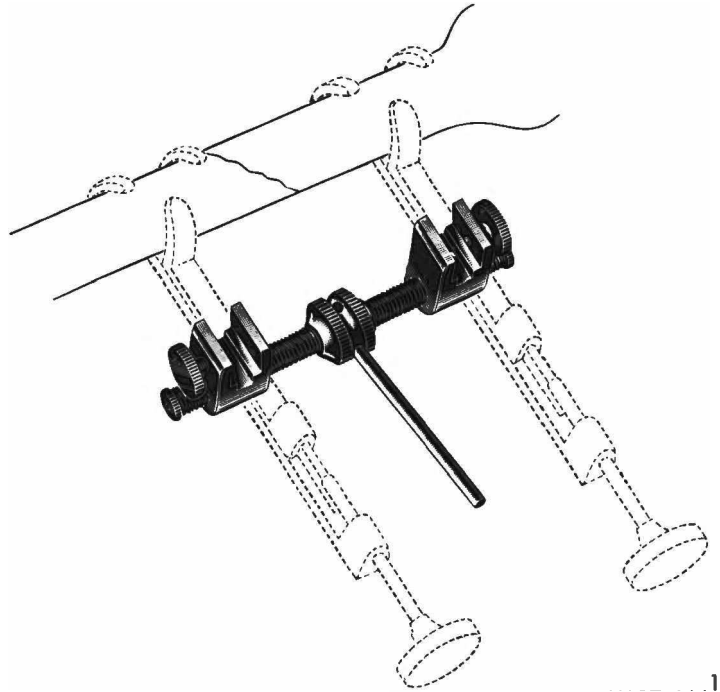

15



PARHAM  
H132-44624



cm	PARHAM
18	H132-44818
30	H132-44830

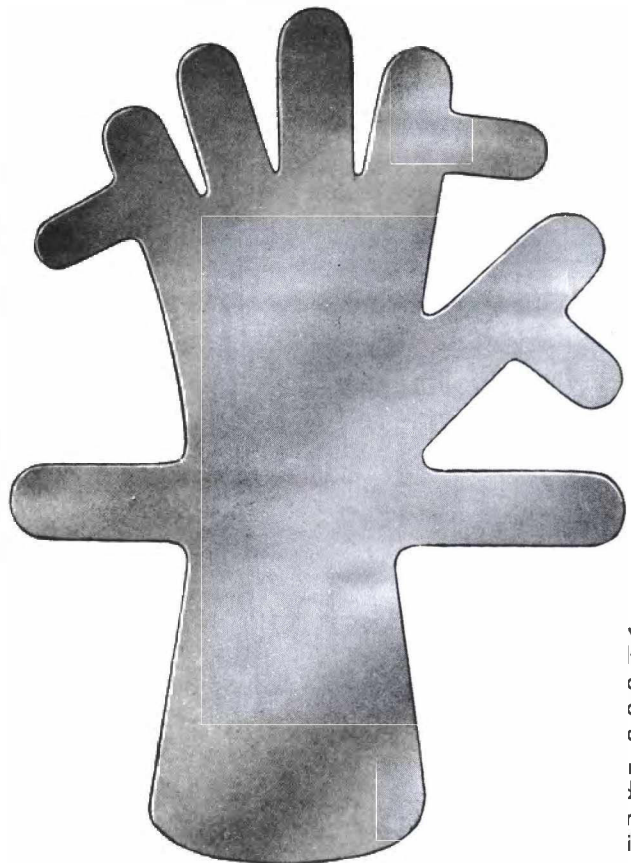

wachsene  
f size  
dultes  
dultos  
dulti  
nder  
f size  
nfants  
ñños  
p. bambini

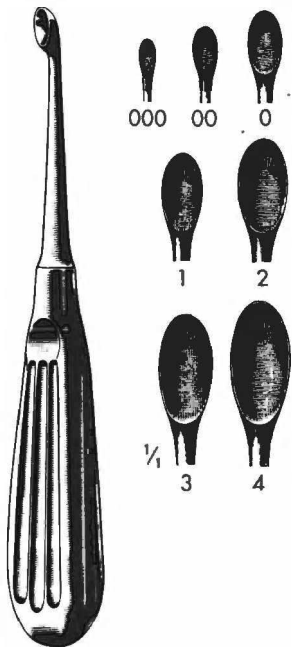

SCHEDE  
H132-46797 - H132-46804

SCHEDE	Fig.	VOLKMANN
	0000	H132-46996
H132-46797	000	H132-46997
H132-46798	00	H132-46998
H132-46800	0	H132-47000
H132-46801	1	H132-47001
H132-46802	2	H132-47002
H132-46803	3	H132-47003
H132-46804	4	H132-47004
	5	H132-47005
	6	H132-47006

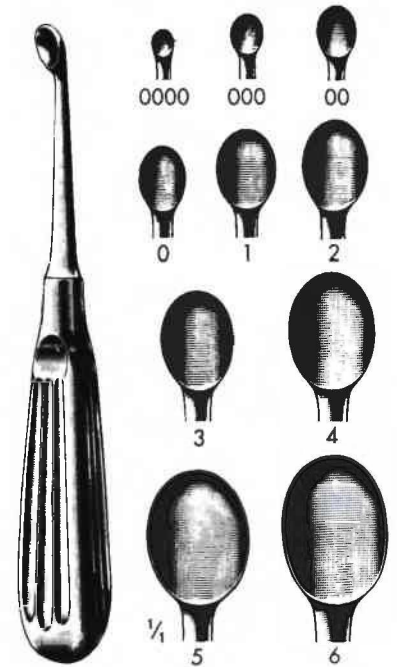

VOLKMANN  
H132-46996 - H132-47006

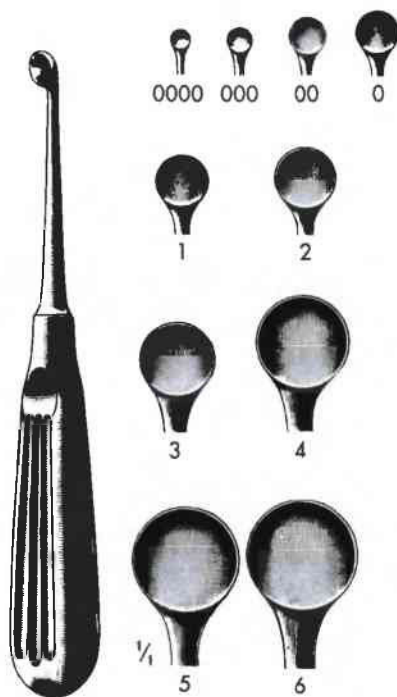

BRUNS  
H132-47196 - H132-47206

BRUNS	Fig.	SPRATT
H132-47196	0000	
H132-47197	000	H132-47497
H132-47198	00	H132-47498
H132-47200	0	H132-47500
H132-47201	1	H132-47501
H132-47202	2	H132-47502
H132-47203	3	H132-47503
H132-47204	4	H132-47504
H132-47205	5	H132-47505
H132-47206	6	

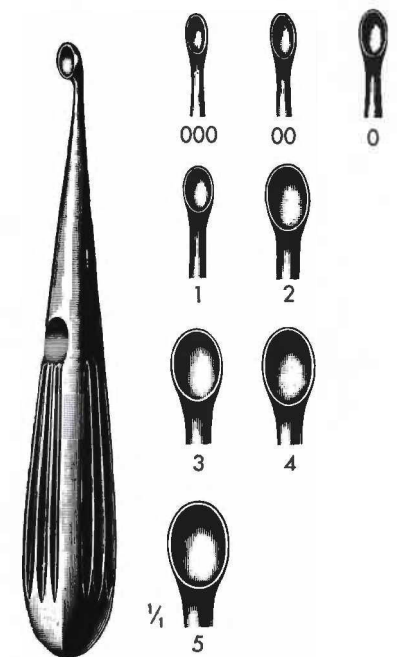

SPRATT  
H132-47497 - H132-47505

Scharfe Löffel  
Bone Curettes  
Curettes à os  
Cucharillas cortantes  
Curette taglianti

132

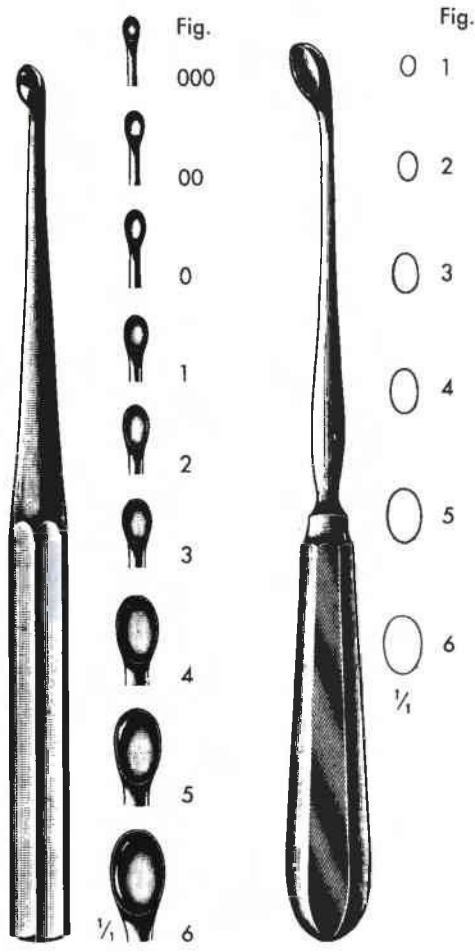

Fig.	BRUNS 23 cm	SIMON 24 cm
000	H132-48097	
00	H132-48098	
0	H132-48100	
1	H132-48101	H132-48501
2	H132-48102	H132-48502
3	H132-48103	H132-48503
4	H132-48104	H132-48504
5	H132-48105	H132-48505
6	H132-48106	H132-48506

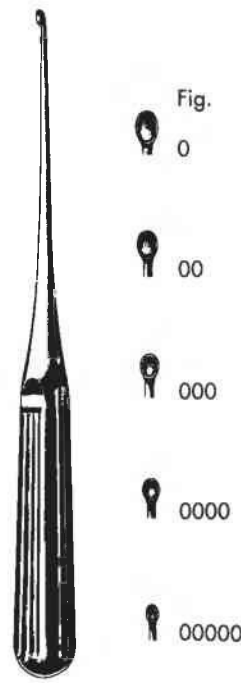

Fig.	LEMPERT 17,5 cm
0	H132-49010
00	H132-49020
000	H132-49030
0000	H132-49040
00000	H132-49050

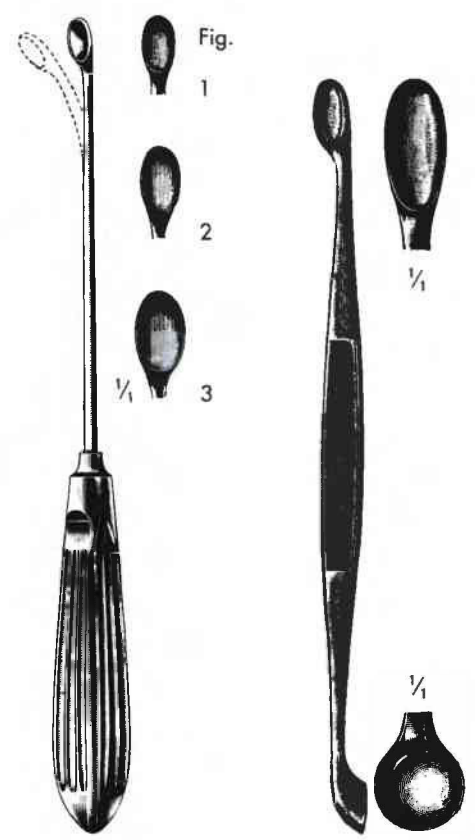

Fig.	HALLE 21 cm	cm	VOLKMANN
1	H132-49101	13	H132-49213
2	H132-49102	16	H132-49216
3	H132-49103	20	H132-49220



cm	VOLKMANN
13	H132-49413
14	H132-49414
17	H132-49417

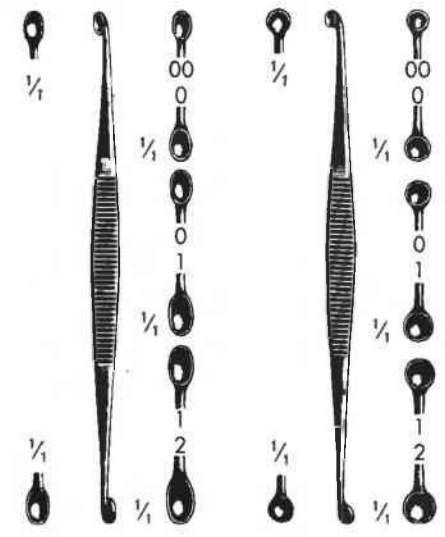
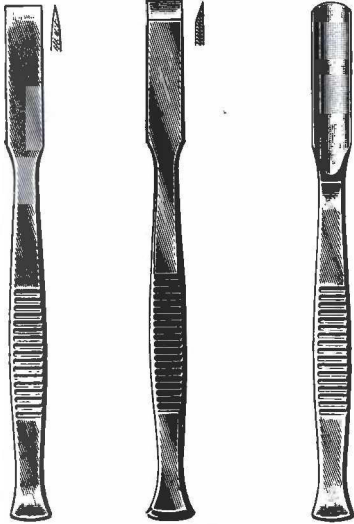
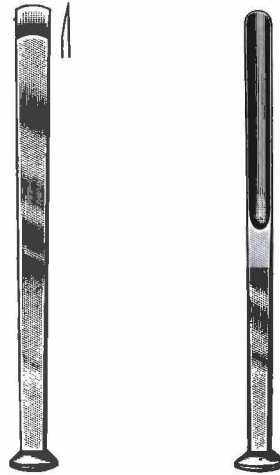

Fig.	WILLINGER 13,5 cm	MARTINI 13,5 cm
00/0	H132-49600	H132-49800
0/1	H132-49601	H132-49801
1/2	H132-49612	H132-49812

**Knochenmeißel**  
**Bone Chisels and Gouges**  
**Ciseaux-burins, gouges**  
**Cinceles, gubias**  
**Scalpelli, sgorbie**



mm	13,5 cm	13,5 cm	13,5 cm
4			
6			
8	H132-60208	H132-60408	H132-60508
10	H132-60210	H132-60410	H132-60510
12	H132-60212	H132-60412	H132-60512
14	H132-60214	H132-60414	H132-60514
16	H132-60216	H132-60416	H132-60516



ALEXANDER		ALEXANDER	
17 cm		17 cm	
	H132-61004		H132-61104
	H132-61006		H132-61106
	H132-61008		H132-61108
	H132-61010		H132-61110
	H132-61012		H132-61112
	H132-61014		H132-61114

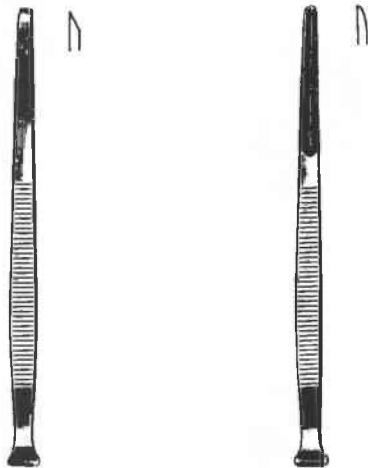

mm	PARTSCH		PARTSCH	
	13,5 cm	17 cm	13,5 cm	17 cm
2	H132-62002	H132-62202	H132-62302	H132-62502
3	H132-62003	H132-62203	H132-62303	H132-62503
4	H132-62004	H132-62204	H132-62304	H132-62504
5	H132-62005	H132-62205	H132-62305	H132-62505
6	H132-62006	H132-62206	H132-62306	H132-62506
7	H132-62007	H132-62207	H132-62307	H132-62507
8	H132-62008	H132-62208	H132-62308	H132-62508

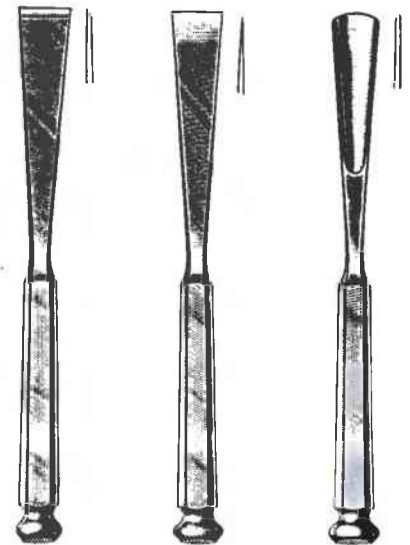

mm	STILLE		STILLE	
	20 cm	20 cm	20 cm	20 cm
10	H132-63010	H132-63210		H132-63310
15	H132-63015	H132-63215		H132-63315
20	H132-63020	H132-63220		H132-63320
25	H132-63025	H132-63225		H132-63325

Knochenmeißel  
Bone Chisels and Gouges  
Ciseaux-burins, gouges  
Cinceles, gubias  
Scalpelli, sgorbie

132

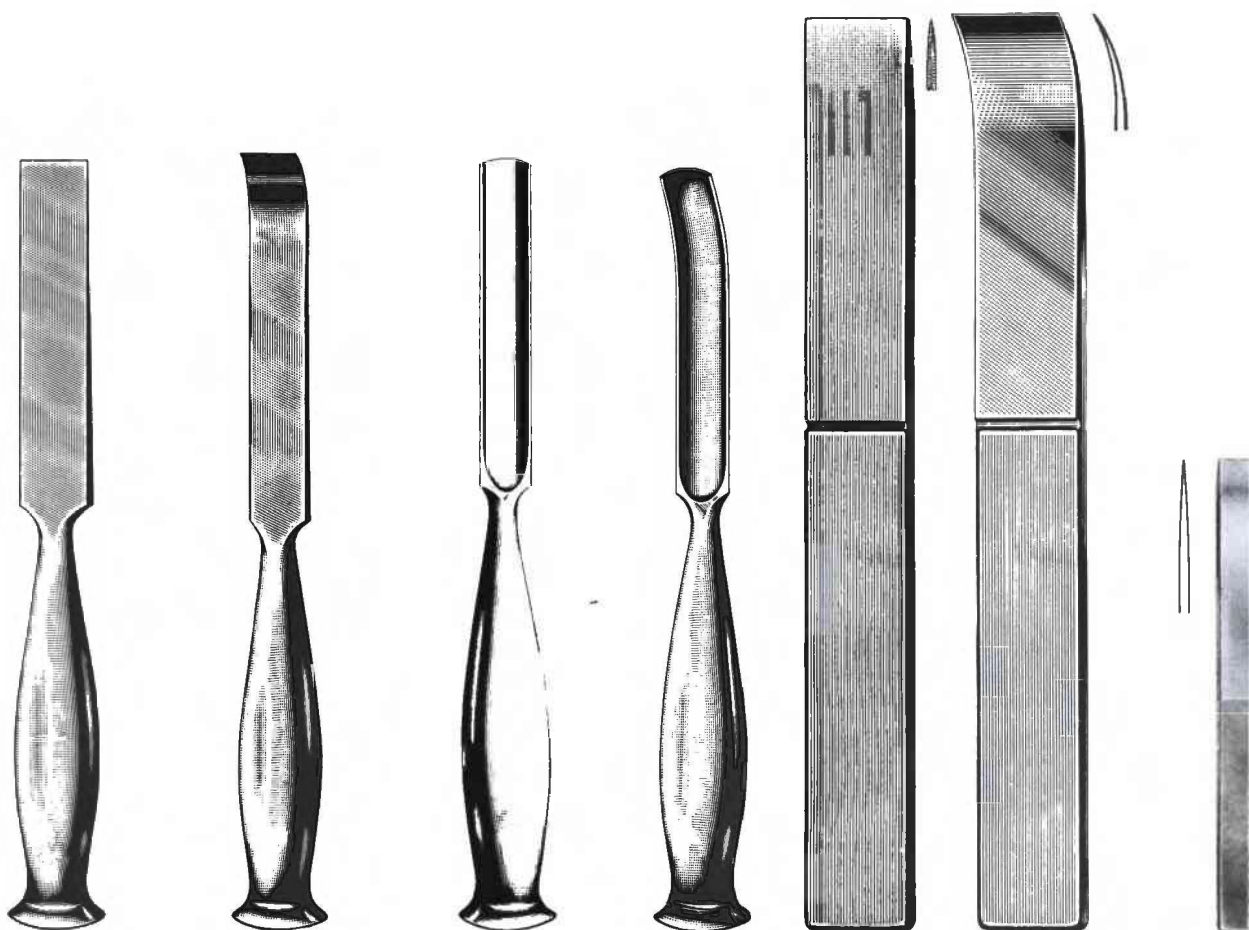

mm	SMITH-PETERSEN			
6	H132-63406	H132-63506	H132-63706	H132-63906
9	H132-63409	H132-63509	H132-63709	H132-63909
13	H132-63413	H132-63513	H132-63713	H132-63913
16	H132-63416	H132-63516	H132-63716	H132-63916
19	H132-63419	H132-63519	H132-63719	H132-63919
25	H132-63425	H132-63525	H132-63725	H132-63925
32	H132-63432	H132-63532	H132-63732	H132-63932
20 cm	20 cm	20 cm	20 cm	20 cm

mm	LAMBOTTE		LAMBOTTE mini	
6,5	H132-65006	H132-65106	3	H132-65403
15	H132-65015	H132-65115	4	H132-65404
20	H132-65020	H132-65120	6	H132-65406
25	H132-65025	H132-65125	8	H132-65408
30	H132-65030	H132-65130	10	H132-65410
38	H132-65038	H132-65138	12	H132-65412
44	H132-65044	H132-65144	15	H132-65415
24 cm	23 cm		12,5 cm	



Knochenmeißel  
Bone Chisels and Gouges  
Ciseaux-burins, gouges  
Cinceles, gubias  
Scalpelli, sgorbie

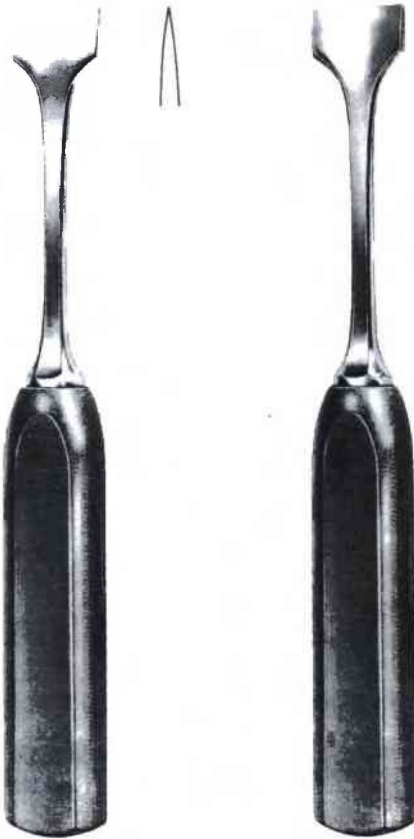

mm	LEXER	LEXER
7	H132-66007	H132-66107
10	H132-66010	H132-66110
15	H132-66015	H132-66115
20	H132-66020	H132-66120
25	H132-66025	H132-66125
30	H132-66030	H132-66130
	22 cm	22 cm

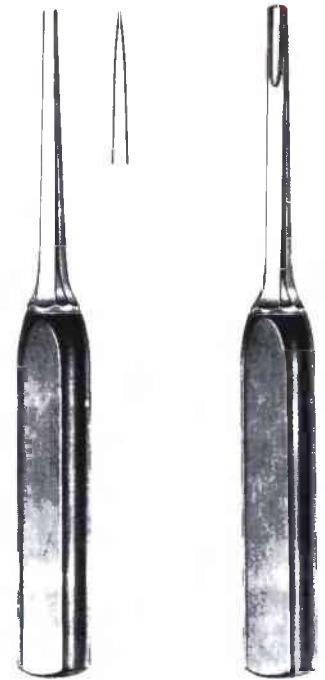

mm	LEXER mini	LEXER mini
4	H132-66404	H132-66504
6	H132-66406	H132-66506
8	H132-66408	H132-66508
10	H132-66410	H132-66510
12	H132-66412	H132-66512



mm	HOKE
3	H132-66803
5	H132-66805
6	H132-66806
8	H132-66808
9	H132-66809
	17 cm

mm	HIBBS		HIBBS		HIBBS	
6	H132-67006	H132-67206	H132-67106	H132-67306	H132-67506	
13	H132-67013	H132-67213	H132-67113	H132-67313	H132-67513	
19	H132-67019	H132-67219	H132-67119	H132-67319	H132-67519	
25	H132-67025	H132-67225	H132-67125	H132-67325	H132-67525	
32	H132-67032	H132-67232	H132-67132	H132-67332	H132-67532	
	24 cm	24 cm	24 cm	24 cm	24 cm	

Knochenmeißel  
Bone Chisels and Gouges  
Ciseaux-burins, gouges  
Cinceles, gubias  
Scalpelli, sgorbie

132

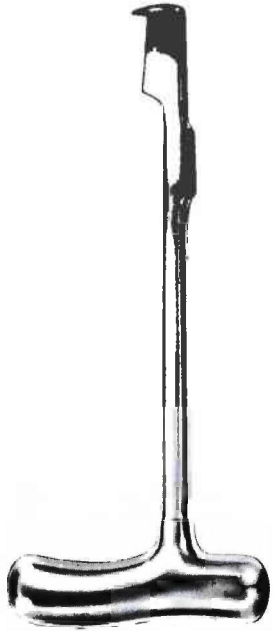

LEBSCHÉ  
H132-67824  
24,5 cm



H132-67922  
22 cm

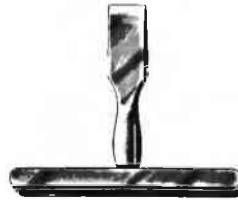

VIRCHOW  
H132-68012



BRUNETTI  
H132-68128  
28 cm



BRUNETTI  
H132-68328  
28 cm

Autopsie-Bestech  
Post Mortem Set  
Set à autopsie  
Juego de autopsía  
Set per autopsia



H132-68400

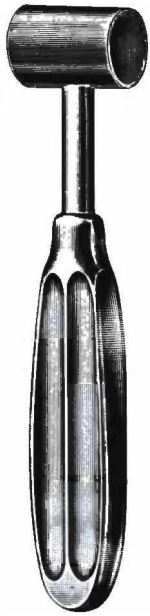

GERZOG  
H132-68625  
18 cm, 250 g

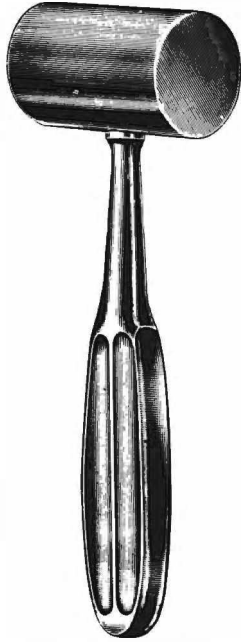

KIRK  
H132-68875  
19 cm, 750 g

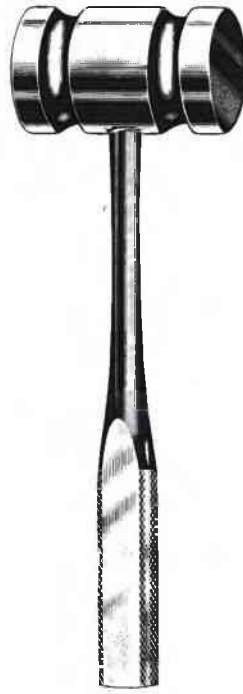

g	
450	H132-69045
900	H132-69090
26,5 cm	



COLLIN  
H132-69222  
20 cm, 220 g



WILLIGER  
H132-69434  
24 cm, 340 g

H132-69702  
Paar Ersatzbacken  
Pair of Spare Faces  
Paire de faces de rechange  
Pareja de tapas intercambiables  
Coppia di teste di ricambio

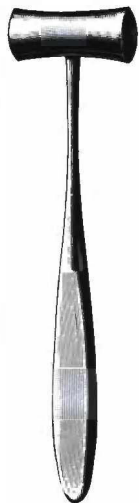

LUCAE  
H132-69626  
19 cm, 260 g



MEAD  
H132-69632  
17 cm, 320 g

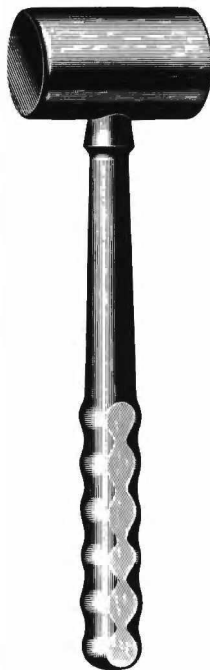

g	
250	H132-69825
400	H132-69840
26 cm	



QUISLING  
H132-69875



H132-69900  
23,5 cm

Raspatorien  
Periosteal Elevators  
Rugines-raspatoires  
Periostótomos  
Periostotomi

32

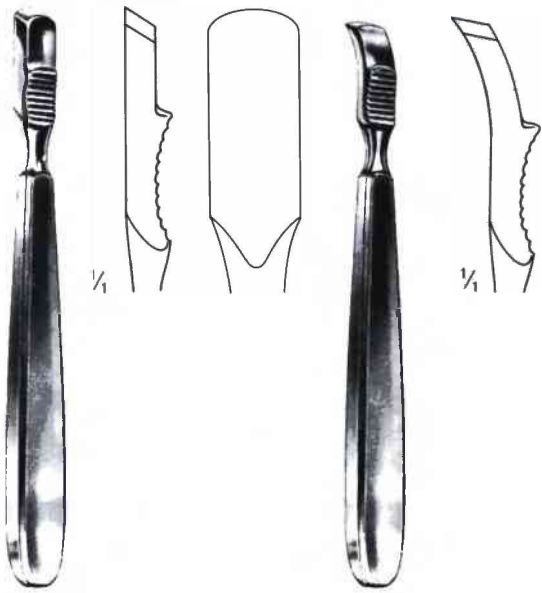

**FARABEUF**  
H132-70215  
15 cm

**FARABEUF**  
H132-70315  
15 cm



mm	LAMBOTTE
10	H132-70510
15	H132-70515
20	H132-70520
25	H132-70525
	21 cm

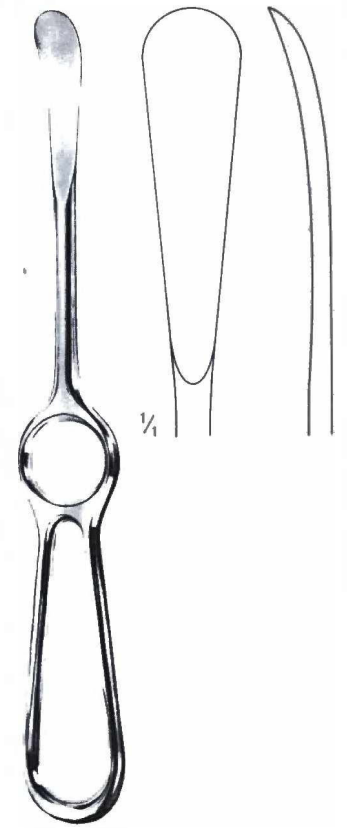

**SEDILLOT**  
H132-70921  
21 cm

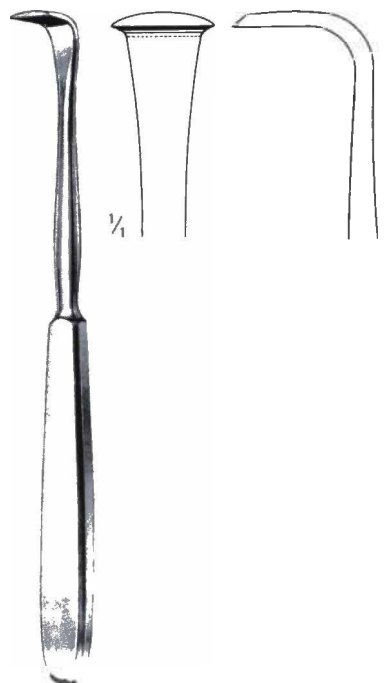

**LANGENBECK**  
H132-71118  
18 cm

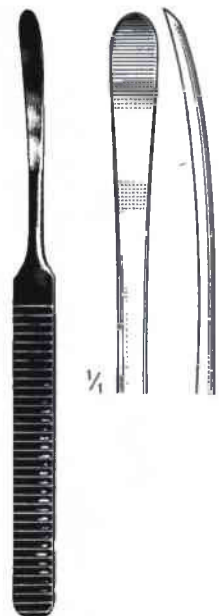

**WILLIGER**  
H132-71316  
16 cm

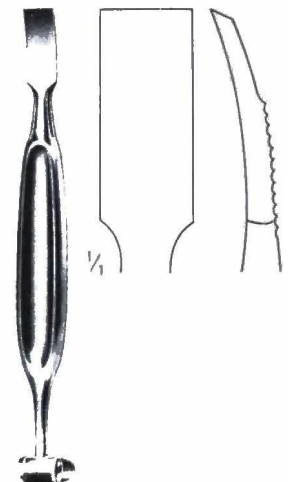

cm	ALEXANDER
16	H132-71516
20	H132-71520

Für Rippen  
Rib  
Pour les côtes  
Para costillas  
Costali



DOYEN DOYEN  
H132-72117 - H132-72717  
17 cm

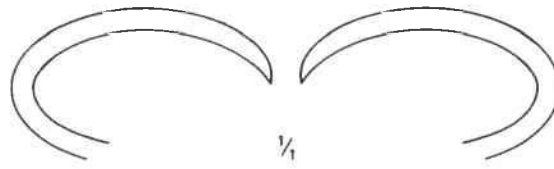

H132-72117 H132-72317

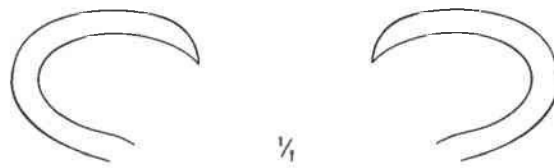

H132-72517 H132-72717



1/2

H132-72901  
17,5 cm

H132-72902  
21,0 cm

H132-72903  
17,5 cm

H132-72904  
21,0 cm

H132-72905  
20,5 cm

H132-72906  
20,5 cm

H132-72907  
22,5 cm

SEMB  
H132-72901 -  
H132-72907



Elevatorien  
Elevators  
Élévateurs  
Elevadores  
Elevatori

32

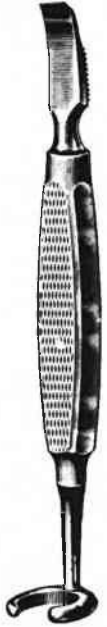

MATSON-ALEXANDER  
H132-73122



MATSON  
H132-73322  
22 cm



OVERHOLT  
H132-73529  
29,5 cm



OVERHOLT  
H132-73729  
29,5 cm



OVERHOLT  
H132-73928  
28,5 cm

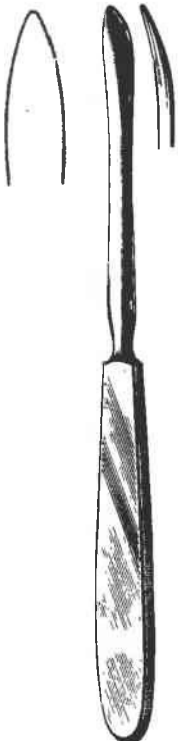

LANGENBECK  
H132-75120  
20 cm



LANGENBECK  
H132-75320  
20 cm



ADSON  
H132-75417 -  
H132-75717  
17 cm



H132-75417 H132-75517



H132-75617 H132-75717



KEY  
H132-75906 -  
H132-75925  
19 cm

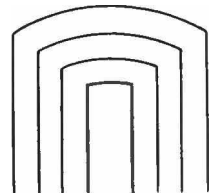

mm	
6	H132-75906
12	H132-75912
19	H132-75919
25	H132-75925

Elevatoren, Knochenhebel  
Elevators, Bone Levers  
Elévateurs, Leviers à os  
Elevadores, E. para huesos  
Elevatori, Elevatori per ossa



WATSON-CHEYNE  
H132-76517  
17,5 cm



McDONALD  
H132-76719  
19 cm



MURPHY-LANE  
H132-76930  
30 cm



BENNETT  
H132-77171  
65 X 260 mm



BENNETT  
H132-77173  
45 X 260 mm

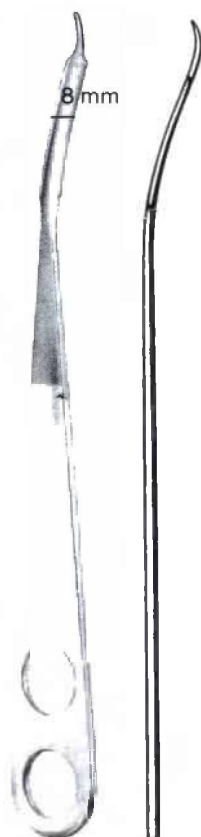

HOHMANN  
H132-80108  
8 mm

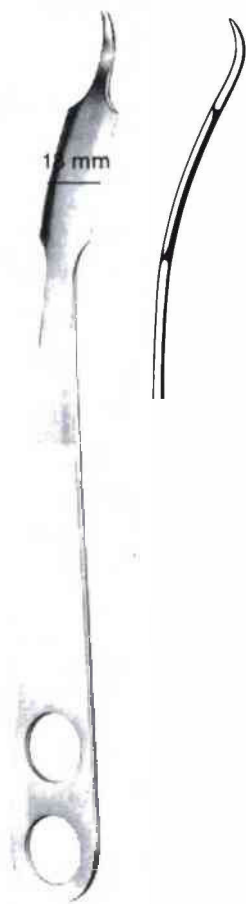

HOHMANN  
H132-80118  
18 mm

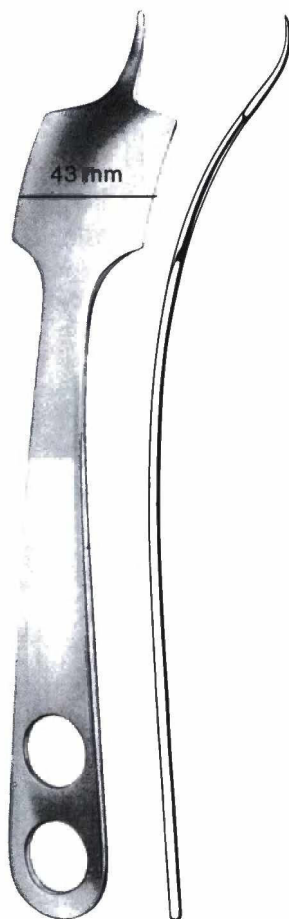

HOHMANN  
H132-80143  
43 mm



HOHMANN  
H132-80170  
70 mm

Knochenhebel  
Bone Levers  
Leviers à os  
Elevadores para huesos  
Elevatori per ossa

132

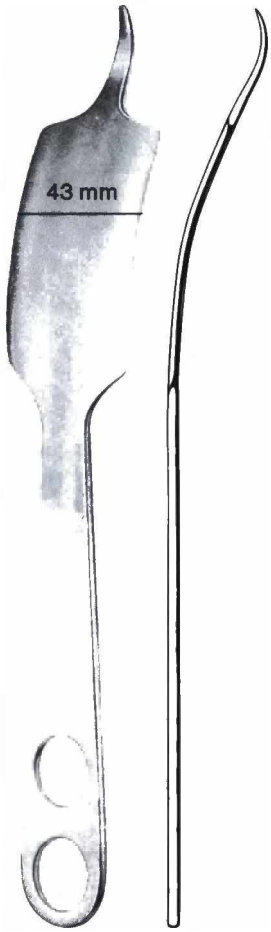

HOHMANN  
H132-80343  
43 mm

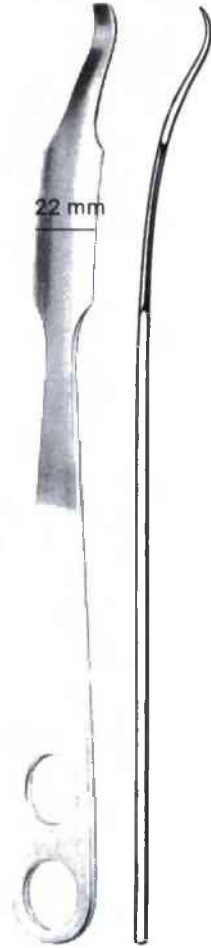

HOHMANN  
H132-80522  
22 mm

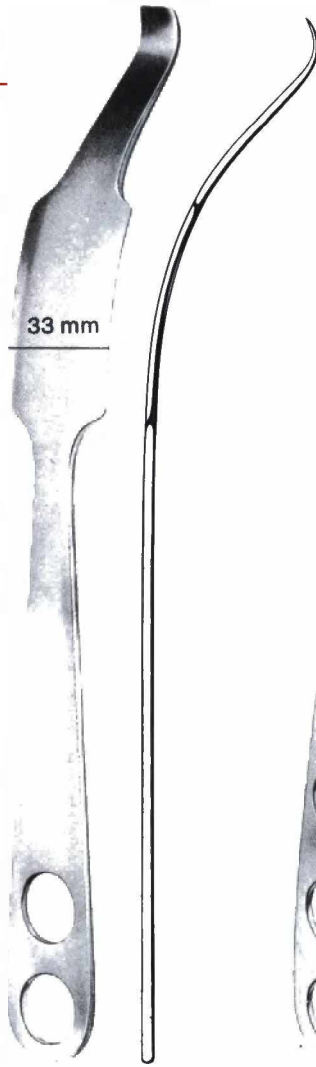

HOHMANN  
H132-80533  
33 mm



HOHMANN  
H132-80724  
24 mm

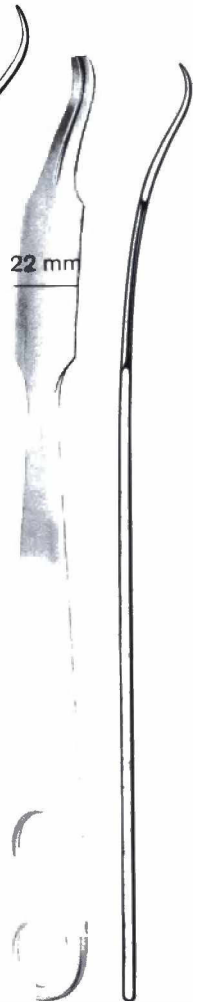

HOHMANN  
H132-80922  
22 mm

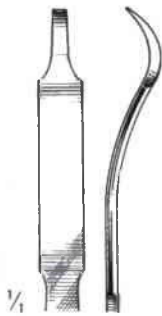

H132-81106  
6 mm

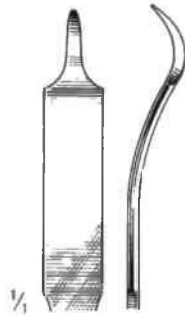

H132-81108  
8 mm

HOHMANN mini  
H132-81106 - H132-81108  
16 cm

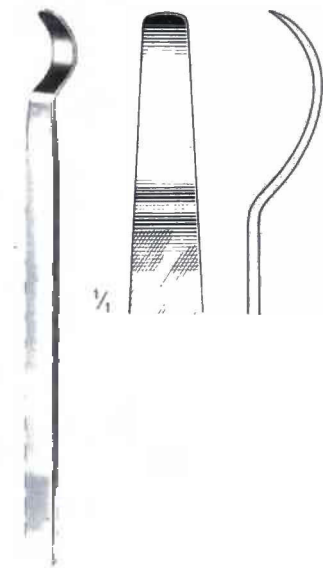

H132-81506  
14 cm

Knochenhebel  
Bone Levers  
Leviers à os  
Elevadores para huesos  
Elevatori per ossa

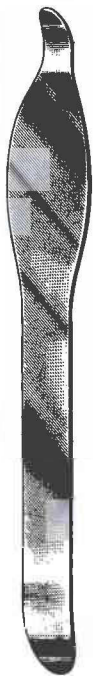

BLOUNT  
H132-82326  
26 cm



BLOUNT  
H132-82526  
26 cm

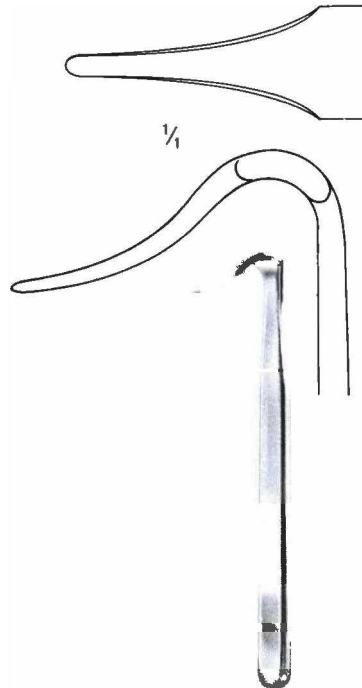

BLOUNT  
H132-82717  
17,5 cm



mm X mm	TAYLOR
75 X 30	H132-83116
100 X 30	H132-83316
	16,5 cm

Meniskotome · Meniscotomes  
Meniscotomes · Meniscótomos  
Meniscotomi



SMILLIE  
H132-91017  
17 cm



H132-91117  
17 cm

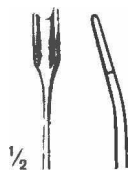

H132-91317  
17 cm



BIRCHER  
H132-91519  
19 cm



BIRCHER  
H132-91719  
19 cm

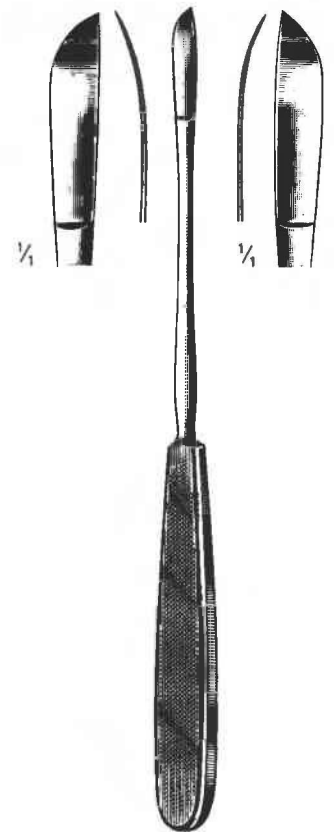

NEFF  
H132-92122 22 cm H132-92322

**Knochenchirurgie**  
**Bone Surgery**  
**Chirurgie osseuse**  
**Cirugía ósea**  
**Chirurgia ossea**

Sehnenstripper, Knochenfeilen  
Tendon Strippers, Bone Files  
Instruments à écorcher les tendos, limes à os  
Separadores para tendones, limas para huesos  
Scollatendini, lime per ossa



H132-95001



H132-95002



H132-95003



H132-95004



H132-95005



BUNNELL  
H132-95001 - H132-95005  
15 cm



H132-97124  
24,5 cm

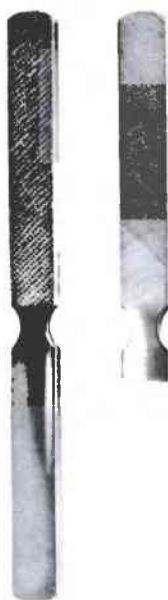

H132-97222  
22 cm



PUTTI  
H132-97327  
27 cm



PUTTI  
H132-97530  
30 cm

Komprimeter zur Erzeugung von Bluteere in den Gliedern  
Compression Apparatus for producing blood vacuum in limbs  
Appareil compressif permettant d'obtenir un milieu exsangue des membres  
Aparato de compresión para producir el vacío de sangre en los miembros  
Vacometro per determinare vuoti di sangue nelle membra



H133-10101  
compl.



Amputation, Finger  
Amputation, Fingers  
Amputation, doigts  
Amputación, dedos  
Amputazione, dita

mm	
3	H133-11203
5	H133-11205
7	H133-11207

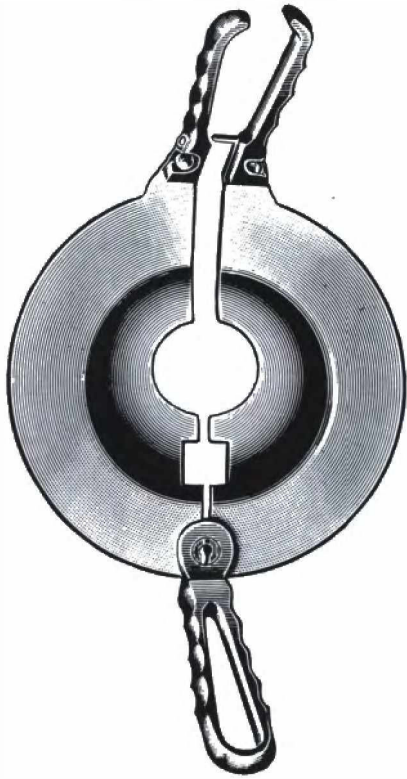

PERCY  
H133-11000



CHARRIERE  
H133-11200



CHARRIERE  
H133-11630  
30 cm



SATTERLEE  
H133-11831  
31 cm



LANGENBECK  
H133-12023  
23 cm



H133-16001



H133-16000  
Compl. incl.  
H133-16001

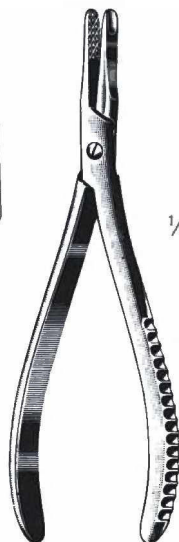
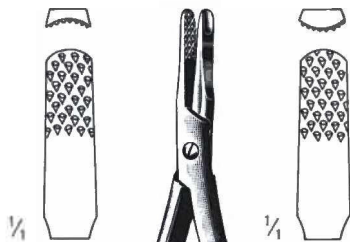

RADOLF  
H133-16213  
13,5 cm



H133-17301

DIMEDA  
H133-17300  
17 cm



H133-17501

H133-17500

Handbohrapparate  
Bone Hand Drills  
Perforateurs à main  
Perforadores a mano  
Perforatori a mano

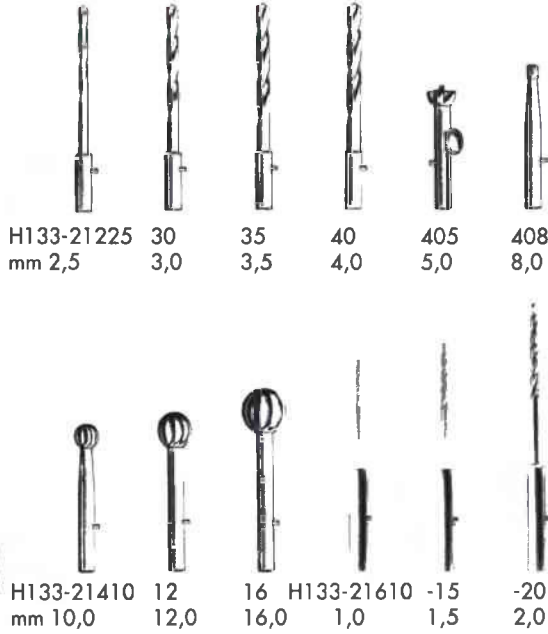
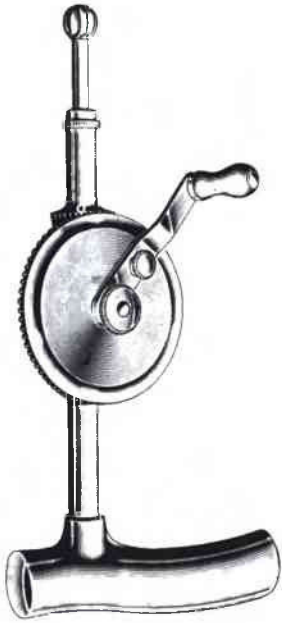

H133-21225 30 35 40 405 408  
mm 2,5 3,0 3,5 4,0 5,0 8,0

H133-21410 12 16 H133-21610 -15 -20  
mm 10,0 12,0 16,0 1,0 1,5 2,0

STILLE

H133-21020  
Compl. 20 cm



H133-22225 -30 -35  
mm 2,5 3,0 3,5

STILLE-SHERMAN

H133-22024  
Compl. 24 cm



H133-23200

MOORE  
H133-23028  
Compl. 28 cm



H133-24209 mm 9 H133-24214 14 H133-24216 16 H133-24222 22

HUDSON  
H133-24027  
Compl. incl. H133-24209, 14, 16, 22, H133-24600  
27 cm



CUSHING H133-24414 H133-24600 McKENZIE H133-24800

Handbohrapparate  
Bone Hand Drills  
Perforateurs à main  
Perforadores a mano  
Perforatori a mano

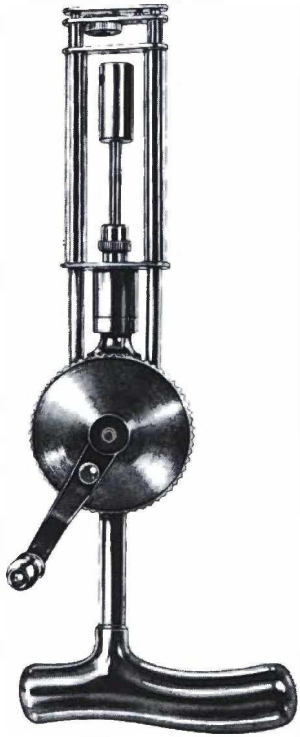

KIRSCHNER  
H133-25000  
Compl.



H133-25200



H133-26000  
Compl.



H133-26200

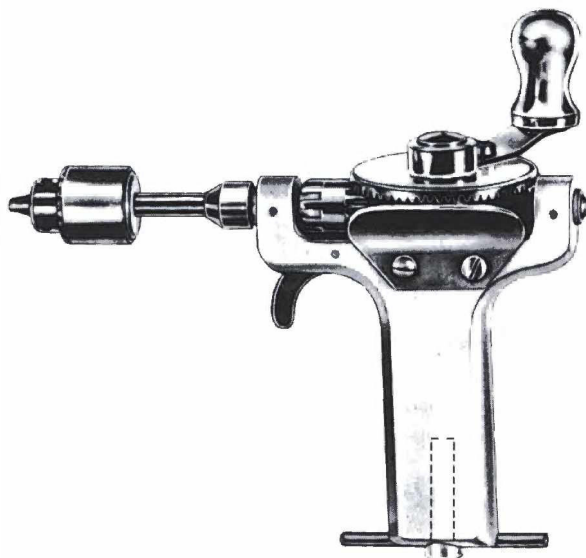

BUNNELL  
H133-27000  
16 cm



RALK  
H133-28000

Bohrapparate  
Bone Drills  
Perforateurs à os  
Perforadores para huesos  
Perforatori per ossa

33



H133-29000



H133-29600



Volt	
220	H133-31000
110	H133-31001



H133-31200

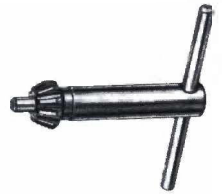

Bohrer, Fräser, Trephinen  
Burs, Drills, Trephines  
Mèches, fraises, trépan  
Taladros, fresas, trefinas  
Trapani, frese, trefine

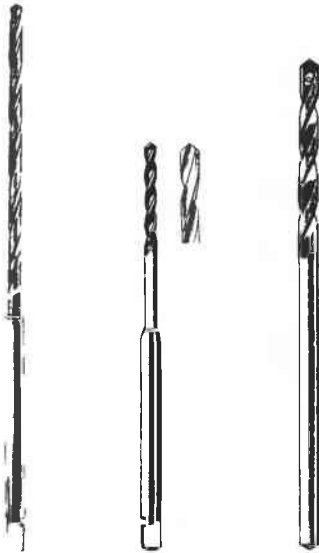

mm			
1,0	H133-35210	H133-35410	
1,2	H133-35212		
1,5	H133-35215	H133-35415	
1,8	H133-35218		
2,0	H133-35020	H133-35220	H133-35420
2,2	H133-35222		
2,5	H133-35025	H133-35225	H133-35425
2,8		H133-35228	H133-35428
3,0	H133-35030	H133-35230	H133-35430
3,2	H133-35032	H133-35232	H133-35432
3,5	H133-35035	H133-35235	H133-35435
4,0	H133-35040	H133-35240	H133-35440
5,0	H133-35050	H133-35250	H133-35450
6,0	H133-35060		H133-35460
7,0	H133-35070		

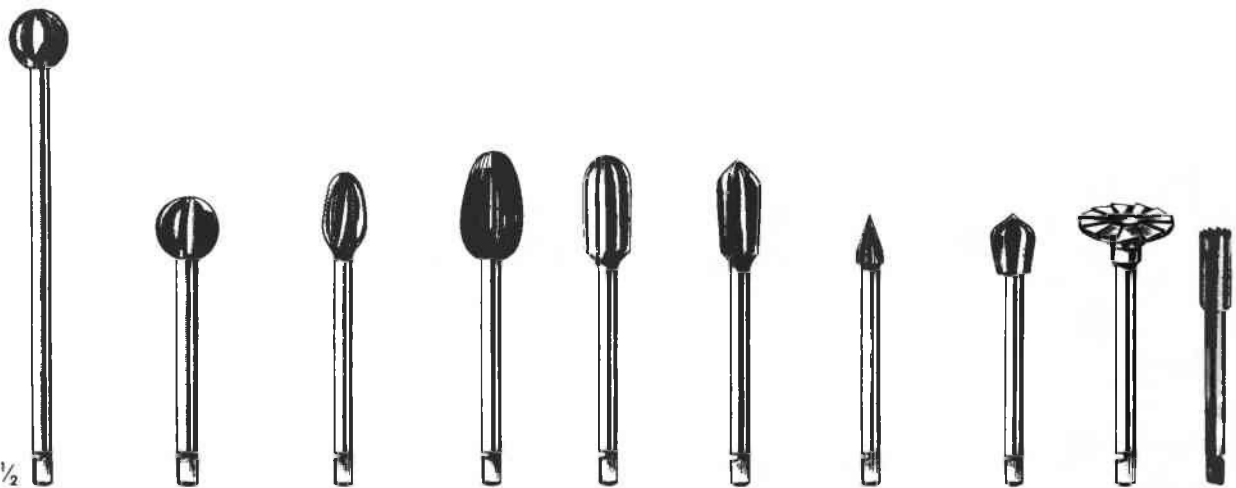

Ø mm	DOYEN	DOYEN	DOYEN	DOYEN	ALBEE	ALBEE	BORCHARDT	TOTI
4	H133-36204	H133-36404						
6	H133-36206	H133-36406						
7						H133-37407		
8	H133-36208	H133-36408		H133-36808	H133-37208			H133-37808
10	H133-36210	H133-36410		H133-36810	H133-37210			
12	H133-36212	H133-36412	H133-36612		H133-37012	H133-37212		
13							H133-37613	
14	H133-36214	H133-36414						
15				H133-37015				
16	H133-36216	H133-36416						
25								H133-37725



Zubehör zum Handmotor  
 Accessories for Bone Engine  
 Accessoires p. moteur à main  
 Accesorios para motor a mano  
 Accessori p. motore a mano

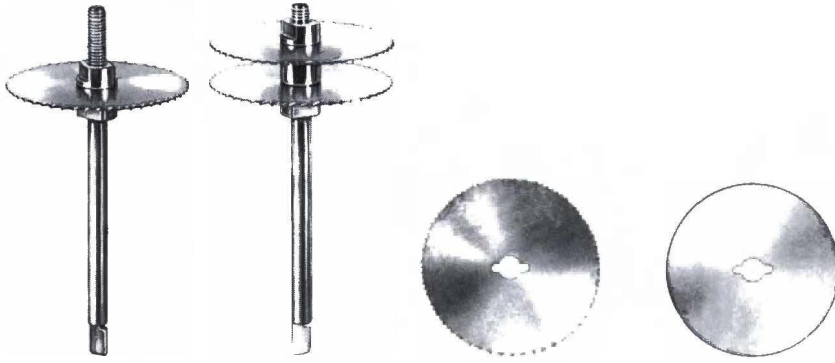

mm Ø			
20	H133-38020	H133-38220	H133-38420
25	H133-38025	H133-38225	H133-38425
30	H133-38030	H133-38230	H133-38430
35	H133-38035	H133-38235	H133-38435
40	H133-38040	H133-38240	H133-38440
45	H133-38045	H133-38245	H133-38445
50	H133-38050	H133-38250	H133-38450

mm Ø			
17	H133-38617		
22	H133-38622		
27	H133-38627		
32	H133-38632		
37	H133-38637		
42	H133-38642		
47	H133-38647		

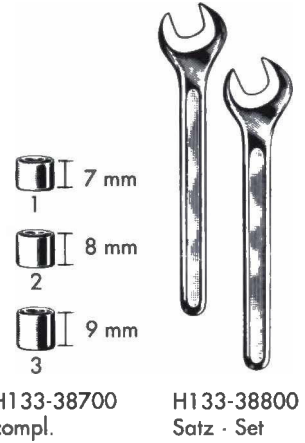

H133-38700  
compl.

H133-38800  
Satz · Set



H133-39000  
compl.

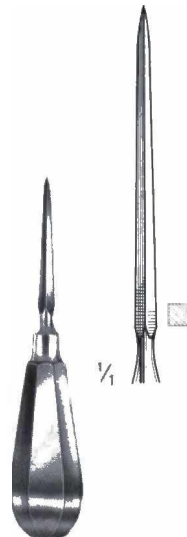

H133-39214  
14 cm

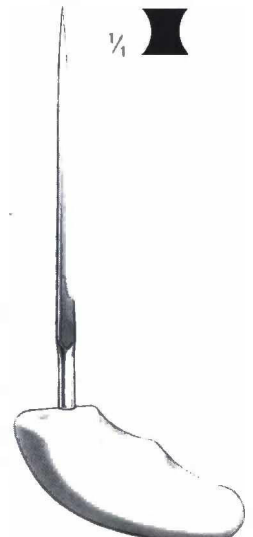

PERTHES  
H133-39521  
21 cm



Trokarspitze  
Trocar tip  
Pointe trocart  
Punta en forma de trócar  
Punte a tre quarti

mm Ø	L = 60 mm	L = 120 mm	L = 140 mm	L = 160 mm	L = 310 mm
1,0	H133-40610	H133-41210	H133-41410	H133-41610	H133-43110
1,2	H133-40612	H133-41212	H133-41412	H133-41612	H133-43112
1,4	H133-40614	H133-41214	H133-41414	H133-41614	H133-43114
1,5	H133-40615	H133-41215	H133-41415	H133-41615	H133-43115
1,6	H133-40616	H133-41216	H133-41416	H133-41616	H133-43116
1,8	H133-40618	H133-41218	H133-41418	H133-41618	H133-43118
2,0	H133-40620	H133-41220	H133-41420	H133-41620	H133-43120
2,2	H133-40622	H133-41222	H133-41422	H133-41622	H133-43122
2,5				H133-41625	H133-43125

KIRSCHNER  
H133-40610 - H133-43125



Lanzenspitze  
Lancet tip  
Pointe lancéolaire  
Punta lanceolar  
Punte lanceolari

mm Ø	L = 310 mm
1,0	H133-43210
1,2	H133-43212
1,5	H133-43215
1,6	H133-43216
1,8	H133-43218
2,0	H133-43220
2,2	H133-43222
2,5	H133-43225

KIRSCHNER  
H133-43210 - H133-43225



STEINMANN Nägel  
STEINMANN Pins  
STEINMANN clous à os  
STEINMANN clavos p. huesos  
STEINMANN chiodi per ossa

L cm	
13	H133-49013
14	H133-49014
15	H133-49015
16	H133-49016
18	H133-49018
20	H133-49020
21	H133-49021

STEINMANN  
H133-49013 - H133-49021

Extensionsbügel  
Extension Bows  
Etriers à extension  
Estribos para extensión  
Archi per estensione

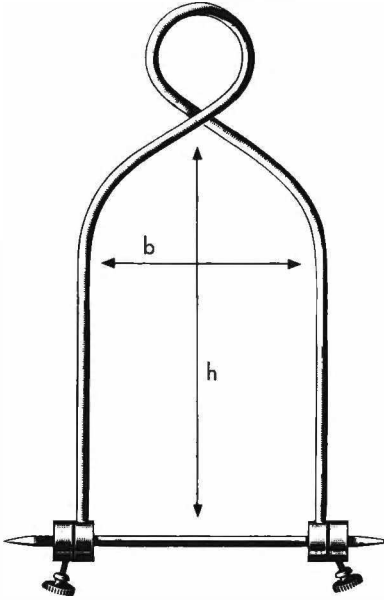

h x b cm	BOEHLER
16 x 9	H133-50216
16 x 11	H133-50221

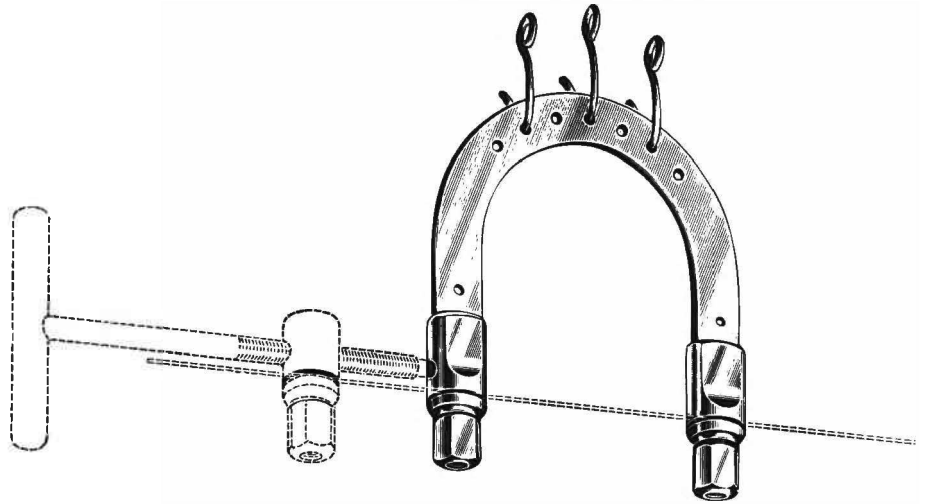

h x b cm	KIRSCHNER
9,5 x 7,0	H133-51209
10,5 x 10,5	H133-51210
12,0 x 12,0	H133-51212
15,5 x 15,5	H133-51215
20,0 x 15,5	H133-51220

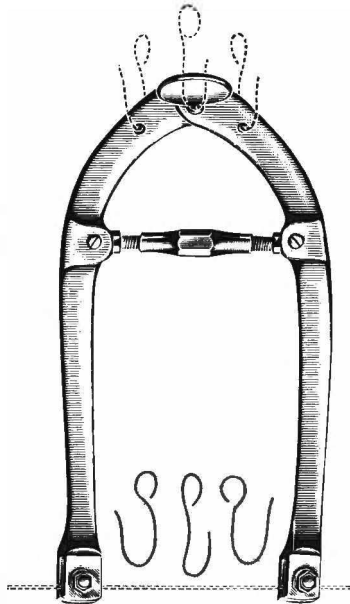

h x b cm	
18 x 10	H133-51418
27 x 16	H133-51427



H133-51501



H133-51502

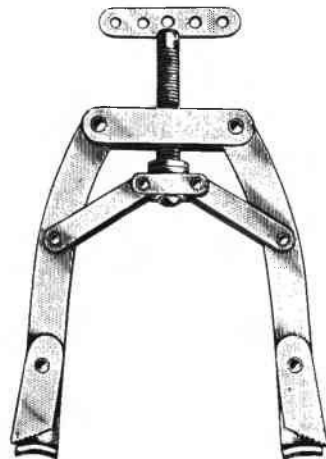

KIRSCHNER U. S.  
H133-51801  
klein · small · petit  
pequeño · piccolo  
H133-51802  
groß · large size  
grand · grande



H133-51901



H133-51902



mm Ø	
0,2	H133-53002
0,3	H133-53003
0,4	H133-53004
0,5	H133-53005
0,6	H133-53006
0,7	H133-53007
0,8	H133-53008
0,9	H133-53009
1,0	H133-53010
1,1	H133-53011
1,2	H133-53012
1,5	H133-53015



LOUTE  
H133-53121  
21 cm

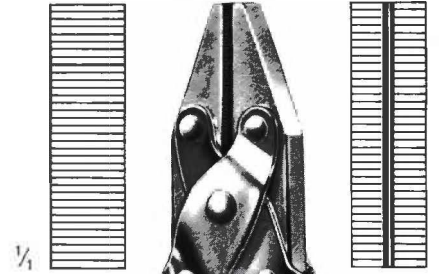

H133-53217  
17 cm

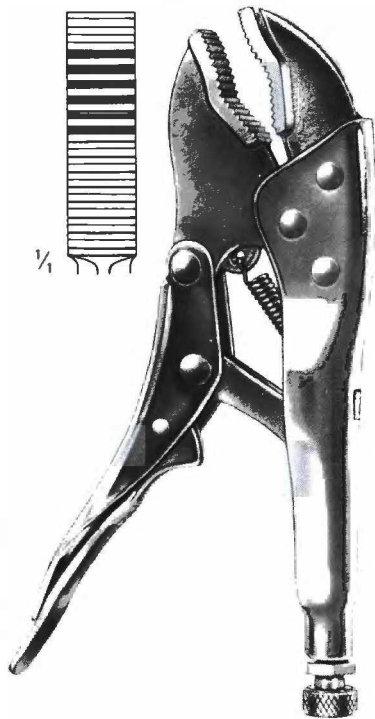

GRIP  
H133-53318  
18 cm

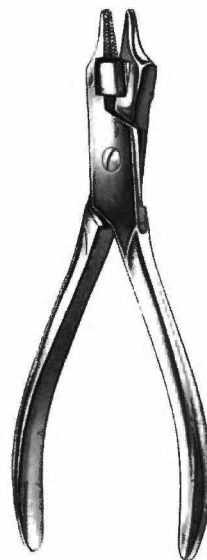

H133-53415  
15 cm

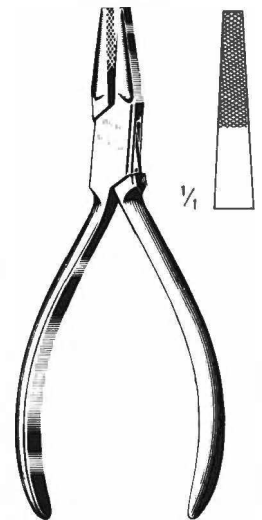
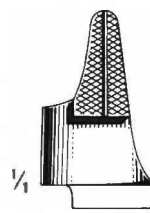

H133-53614  
14 cm

Knochenchirurgie  
Bone Surgery  
Chirurgie osseuse  
Cirugía ósea  
Chirurgia ossea

133

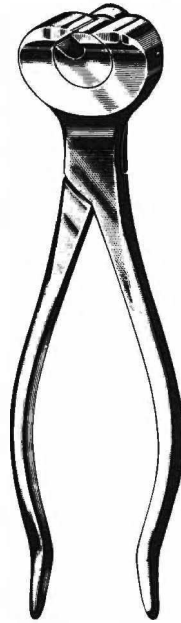

H133-54016  
16 cm

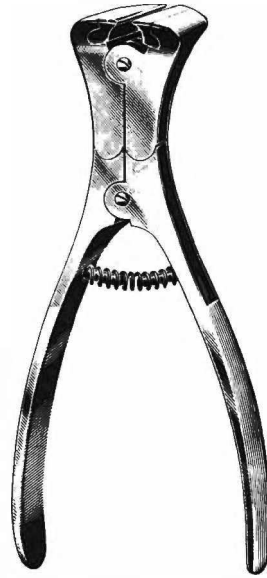

H133-54215  
15 cm



H133-54522  
22 cm

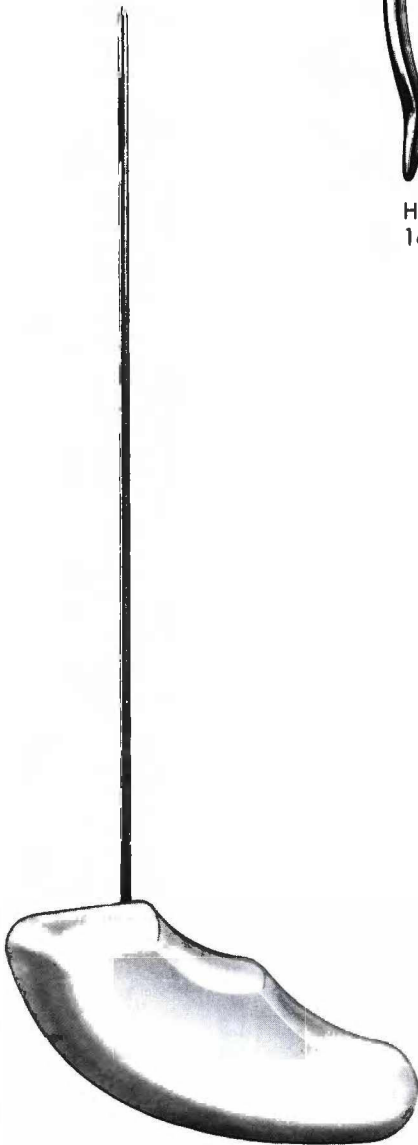

mm Ø	
2,4	H133-56024
3,2	H133-56032
4,8	H133-56048
6,4	H133-56064



H133-56224



H133-56232



H133-56248



H133-56264

f./p. Ø	2,4 mm	3,2 mm	4,8 mm	6,4 mm
---------	--------	--------	--------	--------



Knochen Nagelung  
Bone Nailing  
Enclouage des os  
Enclavamiento de huesos  
Inchiodamento di ossa

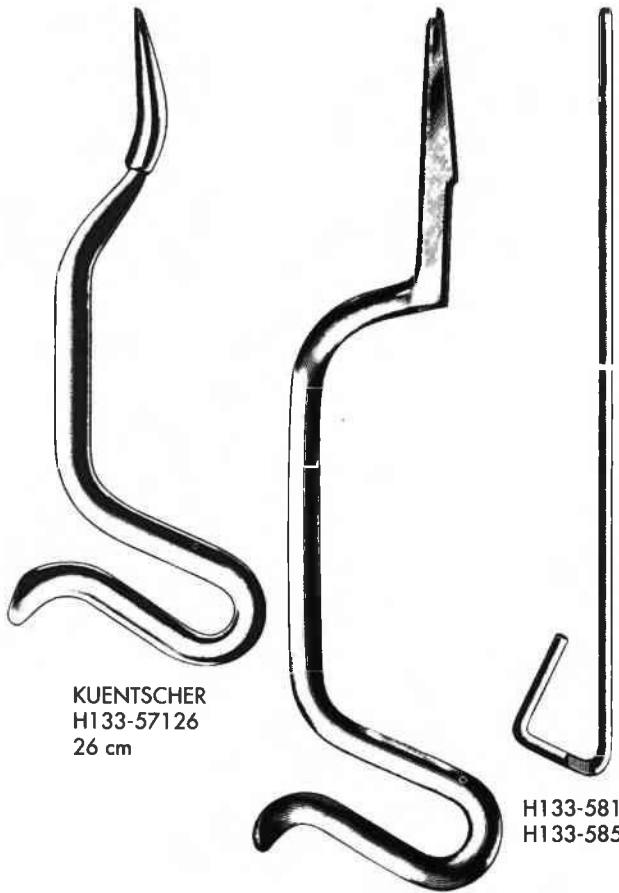

KUENTSCHER  
H133-57126  
26 cm



H133-58135 -  
H133-58560



KUENTSCHER  
H133-57335  
35 cm

mm Ø	L = 35 cm	L = 46cm	L = 60 cm
2,5	H133-58135	H133-58146	
3,0	H133-58235	H133-58246	
3,5	H133-58335	H133-58346	H133-58360
4,0	H133-58435	H133-58446	H133-58460
5,0	H133-58535	H133-58546	H133-58560

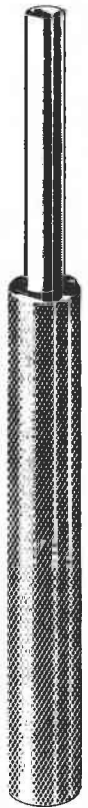

KUENTSCHER  
H133-58621  
21 cm



KUENTSCHER  
H133-58821  
21 cm



1/3  
H133-59001



1/3  
H133-59002



1/3  
H133-59003



H133-59004



KUENTSCHER  
H133-59000  
63 cm

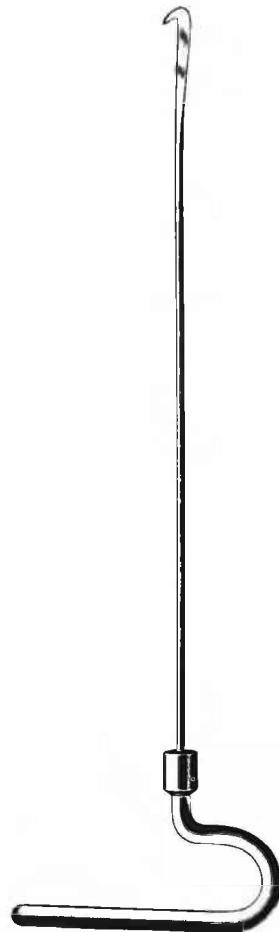

cm	
29	H133-59629
37	H133-59637
42	H133-59642
49	H133-59649



H133-59830

Instrumente zur Osteosynthese  
Osteosynthesis Instruments  
Instruments p. ostéosynthèse  
Instrumentos p. osteosíntesis  
Strumenti per osteosintesi

133



LLOYD  
H133-60220  
20 cm



LANE  
H133-62025  
25 cm



WILLIAMS  
H133-62424  
24 cm



mm	
2,5	H133-62825
3,5	H133-62835



LANE  
H133-63225  
25 cm



LANE  
H133-63518  
18 cm

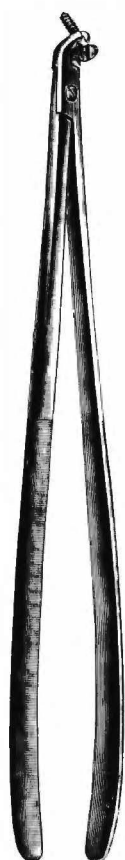

LANE  
H133-63723  
23 cm

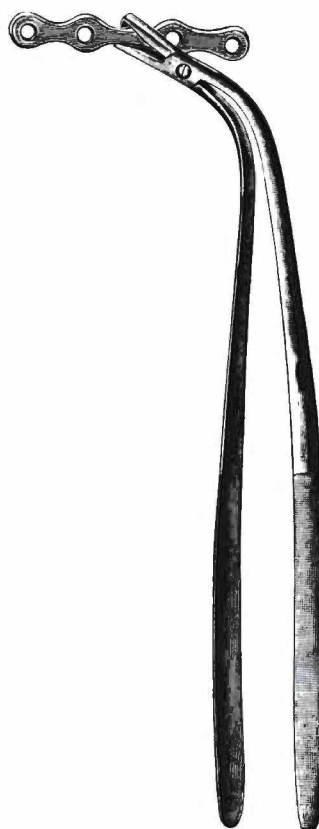

LANE  
H133-63922  
22 cm

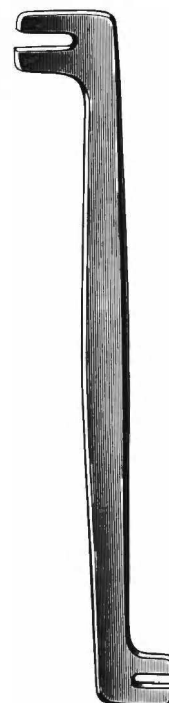

LANE  
H133-64018  
18 cm

Instrumentarium zum Einbringen von Hohlschrauben  
Instrument Set for Cannulated Screws  
Instrumentation pour l'application des vis à perforation longitudinale  
Instrumental para la aplicación de tornillos de perforación longitudinal  
Strumentario per viti cannulate

Instrumente zur Osteosynthese  
Osteosynthesis Instruments  
Instruments p. ostéosynthèse  
Instrumentos p. osteosíntesis  
Strumenti per osteosintesi



Ø mm  
4,5 H133-80245  
7,0 H133-80270



H133-81005  
5 mm

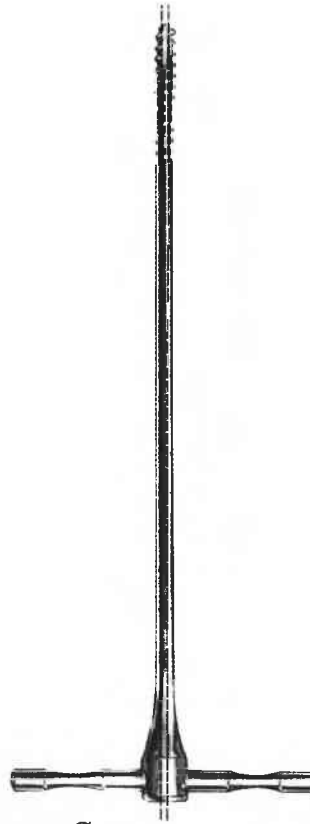

Ø mm  
4,5 H133-81245  
7,0 H133-81270



Ø mm  
2,5 H133-81625  
3,5 H133-81635  
5,0 H133-81650



H133-82000

Hohlschrauben siehe Seite 152  
Cannulated Screws see page 152  
Vis à perforation longitudinale, voir p. 152  
Tornillos de perforación longitudinal, véanse pág. 152  
Viti cannulate, vedere pag. 152

Hirnnaht  
Brain Suture  
Suture cérébrale  
Sutura cerebral  
Sutura cerebrale

40

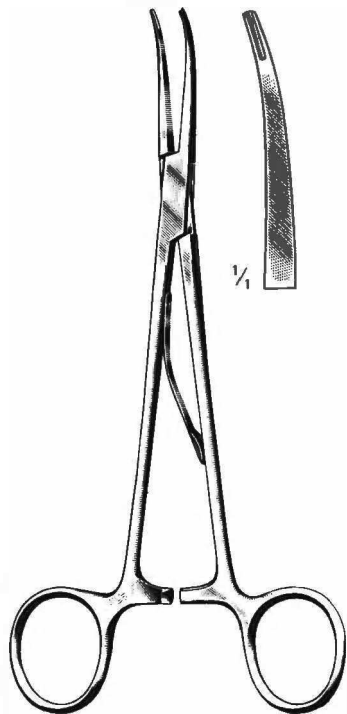

cm	McKENZIE
15	H140-01115
19	H140-01119

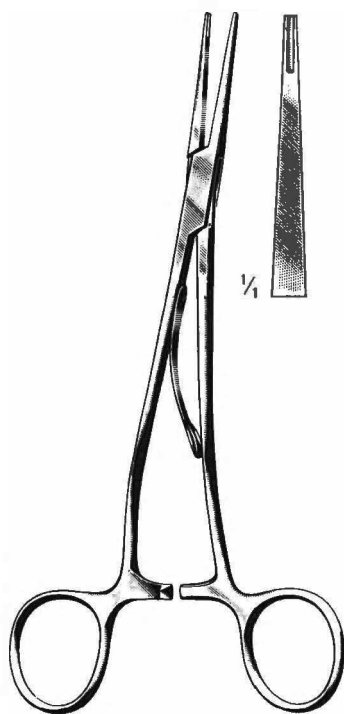

cm	McKENZIE
15	H140-01315
19	H140-01319

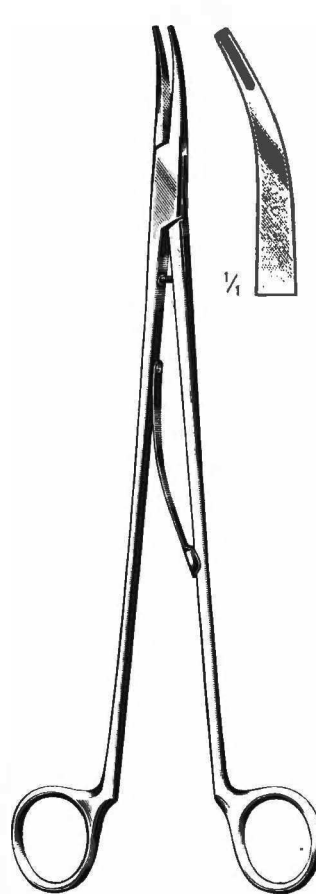

cm	SMITHWICK
23	H140-01523
26	H140-01526

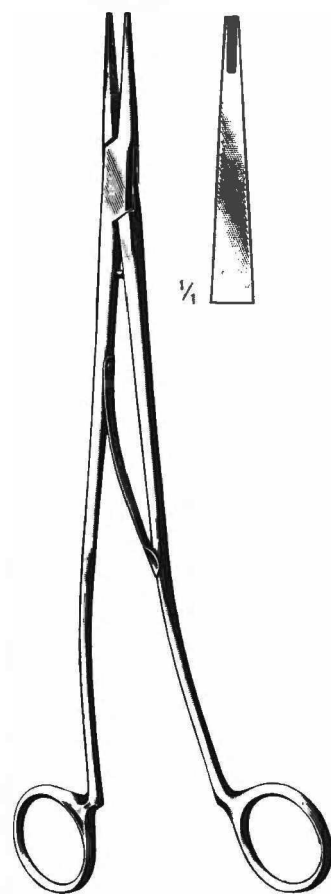

cm	SWEET
23	H140-01723
26	H140-01726



OLIVECRONA-TOENNIS  
H140-01914



H140-02000  
148 x 40 x 6 mm

Schädelhalter  
Cervical Traction Tongs  
Pincès de traction crânienne  
Pinzas de tracción cranial  
Pinze per trazione craniale

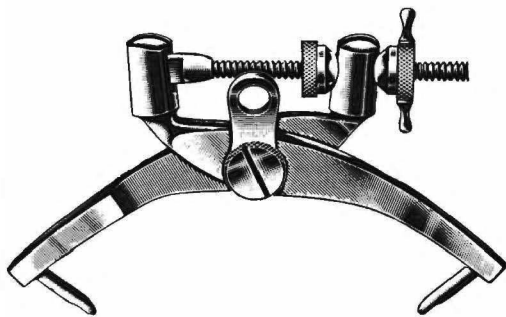

CRUTCHFIELD  
H140-02501



CRUTCHFIELD  
H140-02502



H140-02635  
3,5 mm Ø



H140-02650  
5 mm Ø

Kopfhautklammer, -anlegezange  
Scalp Hemostasis Clip, Applying Forceps  
Pince hémostatique pour le cuir chevelu, pince à poser  
Pinza hemostática para cuero cabelludo, pinza para poner  
Pinza emostatica per il cuoio capelluto, pinza per applicare e togliere



RANEY  
H140-02700

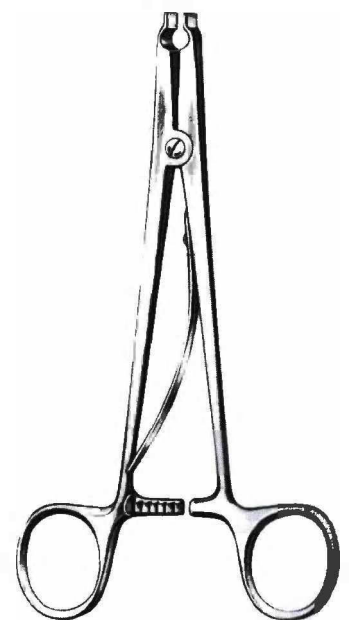

RANEY  
H140-02800



Nervhaken  
Nerve Retractors  
Ecarteurs à nerfs  
Separadores para nervios  
Divaricatori per nervi

140

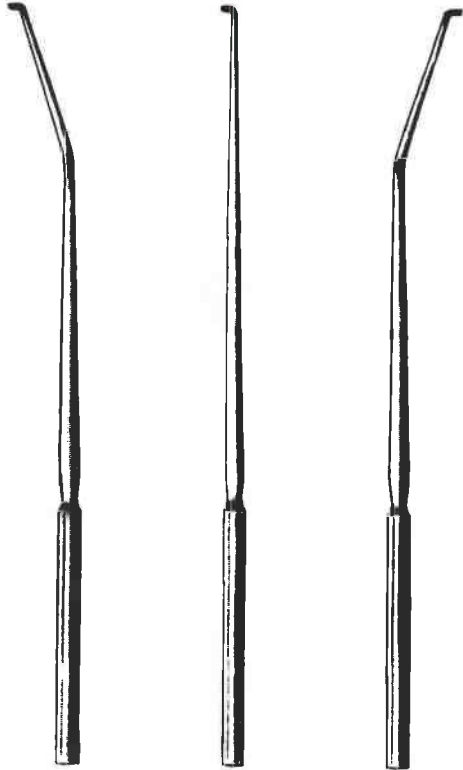

DANDY  
H140-05120  
20 cm

DANDY  
H140-05220  
20 cm

DANDY  
H140-05320  
20 cm

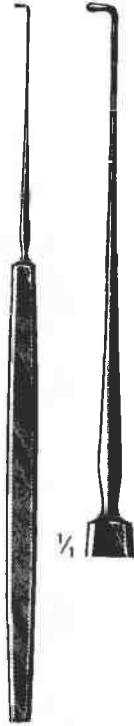

CUSHING  
H140-05628  
28 cm

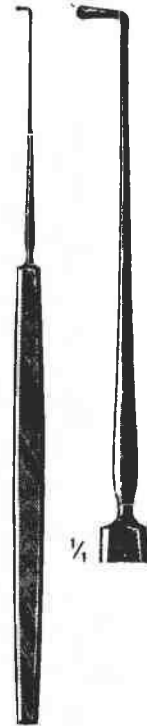

CUSHING  
H140-05828  
28 cm



GRAHAM  
H140-06116  
16,5 cm



SACHS  
H140-06418  
18,5 cm



ADSON  
H140-06820  
20 cm



ADSON  
H140-06920  
20 cm



SMITHWICK  
H140-07029  
29 cm



H140-08019



H140-08119

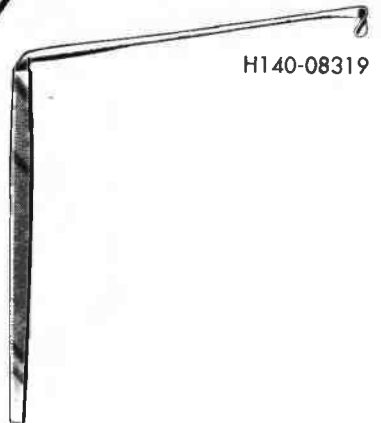

H140-08319

LOVE  
H140-08019 - H140-08319



De MARTEL  
H140-09033  
33 cm

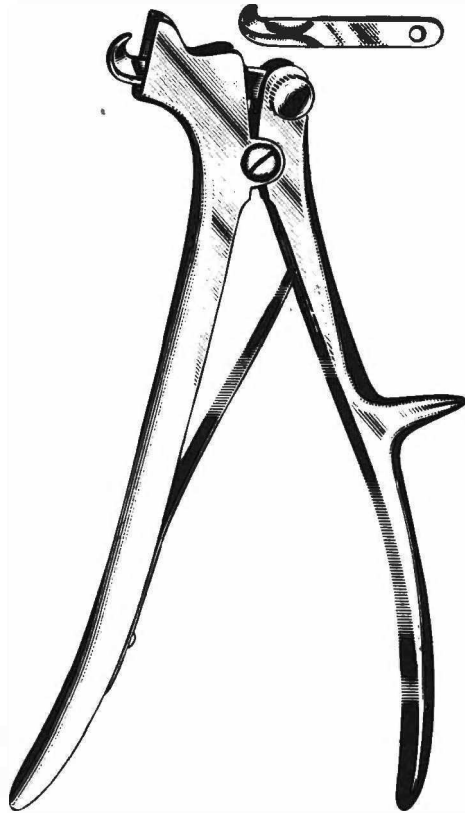

De VILBISS  
H140-09621  
21 cm

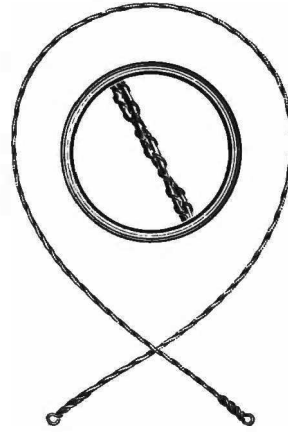

cm	OLIVECRONA
30	H140-09230
40	H140-09240
50	H140-09250
60	H140-09260
70	H140-09270

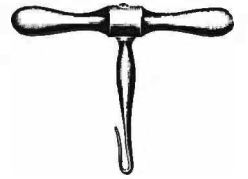

GIGLI  
H140-09400

Dura-Dissektoren · Dura Dissectors · Dissecteurs à duremère  
Descoladores para la duramadre · Scollatori per la duramadre



TOENNIS  
H140-14125  
25 cm



SACHS  
H140-14321



SACHS  
H140-14521



MILLIGAN  
H140-14721



H140-14922



DAVIS  
H140-15124

Neurochirurgie  
Neurosurgery  
Neurochirurgie  
Neurocirugía  
Neurochirurgia

140

Dura-Dissektoren, -Messer  
Dura Dissectors, Knife  
Dissecteurs bistouri à duremère  
Descoladores, bisturi para duramadre  
Scollatori, bisturi per duramadre

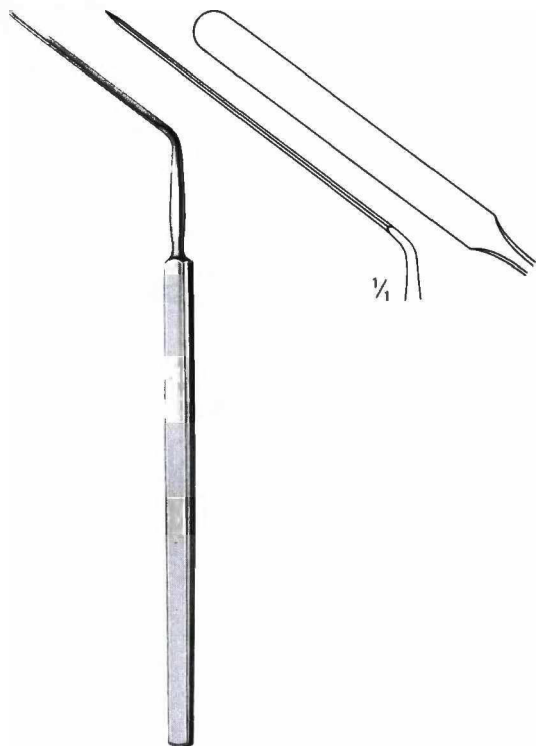

HORSLEY  
H140-15520  
20 cm



PENFIELD  
H140-16101  
17,5 cm



PENFIELD  
H140-16102  
19,5 cm



PENFIELD  
H140-16103  
19,5 cm



HALLE  
H140-17020

Hypophysenpinzetten · Hypophyseal Forceps  
Pincas à hypophyse · Pinzas para hipófisis · Pinze per ipofisi



ADSON  
H140-21023



ADSON  
H140-21123



ADSON  
H140-21323

Hirnspatel, Saugrohre  
Brain Spatulas, Aspir. Tubes  
Spatules cérébr., tubes d'aspir.  
Espátulas cerebr., tubos de aspir.  
Spatole cerebr., tubi per aspiraz.

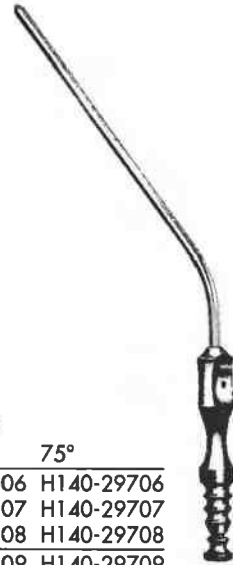
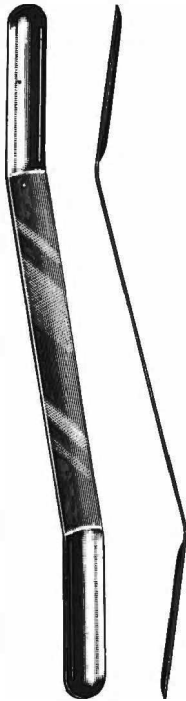
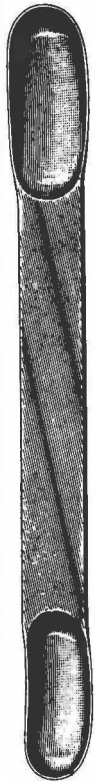

mm	CUSHING
7/9	H140-25007
11/13	H140-25011
15/18	H140-25015
18/22	H140-25018

mm	OLIVECRONA
7/9	H140-25307
11/13	H140-25311
15/18	H140-25315
18/22	H140-25318

mm	HEIFETZ
8	H140-26008
11	H140-26011
14	H140-26014
17	H140-26017

	ADSON
	H140-29021
21 cm/4 mm	

Charr.	♀	
F.G.	30°	75°
6	H140-29506	H140-29706
7	H140-29507	H140-29707
8	H140-29508	H140-29708
9	H140-29509	H140-29709
10	H140-29510	H140-29710
11	H140-29511	H140-29711
12	H140-29512	H140-29712

FRAZIER  
19 cm

Wirbelkörperspreizer  
Lamina Spreaders  
Ecarteurs pour corps vertébraux  
Separadores para cuerpos vertebrales  
Divaricatori per corpi vertebrali



FRAZIER  
H140-29812  
12 cm/3 mm



CLOWARD  
H140-40116



INGE  
H140-40517 - H140-40527

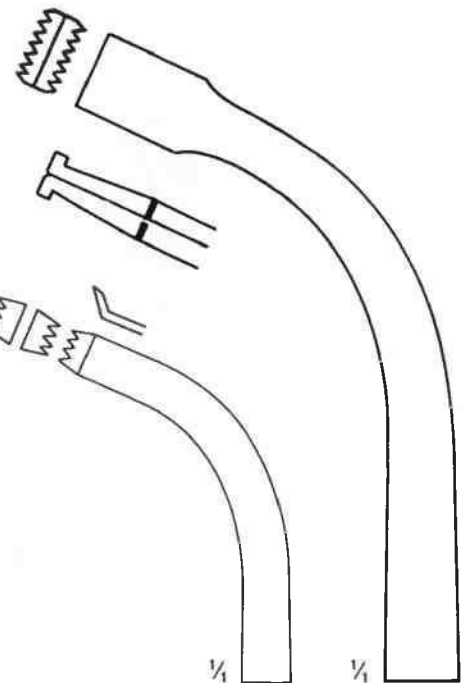

H140-40517 17 cm  
H140-40527 27 cm

Laminektomie  
Laminectomy  
Laminectomie  
Laminectomía  
Laminectomia

Laminektomie-Zangen  
Laminectomy Rongeurs  
Pincas emporte-pièce à laminectomie  
Pinzas cortantes para laminectomía  
Pinze taglianti per laminectomia

140



**CUSHING**  
2 mm



2 x 10 mm	L
H140-42001	12,5 cm
H140-42201	18,0 cm



2 x 10 mm/45°	L
H140-42002	12,5 cm
H140-42202	18,0 cm



2 x 10 mm/45°	L
H140-42003	12,5 cm
H140-42203	18,0 cm

**LOVE-GRUENWALD**  
3 mm



3 x 10 mm	L
H140-43001	12,5 cm
H140-43201	18,0 cm

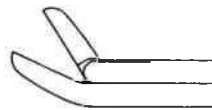

3 x 10 mm/45°	L
H140-43002	12,5 cm
H140-43202	18,0 cm

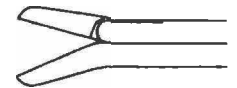

3 x 10 mm/45°	L
H140-43003	12,5 cm
H140-43203	18,0 cm

**SPURLING**  
4 mm



4 x 10 mm	L
H140-44001	12,5 cm
H140-44201	18,0 cm



4 x 10 mm/45°	L
H140-44002	12,5 cm
H140-44202	18,0 cm

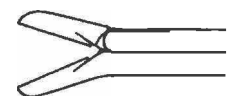

4 x 10 mm/45°	L
H140-44003	12,5 cm
H140-44203	18,0 cm



Laminektomie-Zangen  
Laminectomy Rongeurs  
Pincas emporte-pièce à laminectomie  
Pinzas cortantes para laminectomia  
Pinze taglianti per laminectomia

Laminektomie  
Laminectomy  
Laminectomie  
Laminectomía  
Laminectomia

140

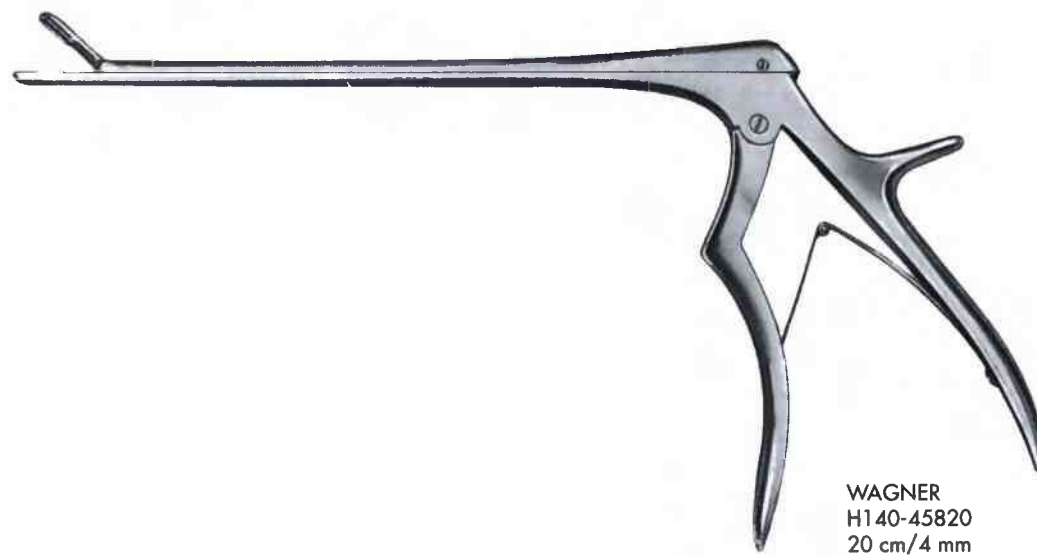
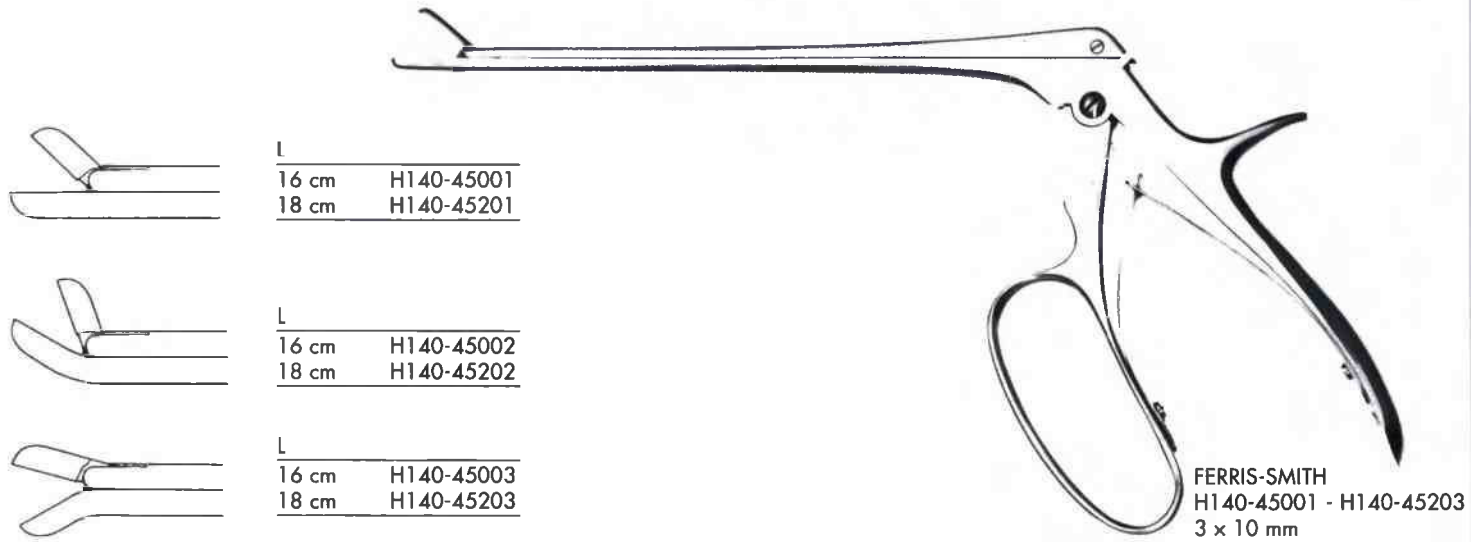
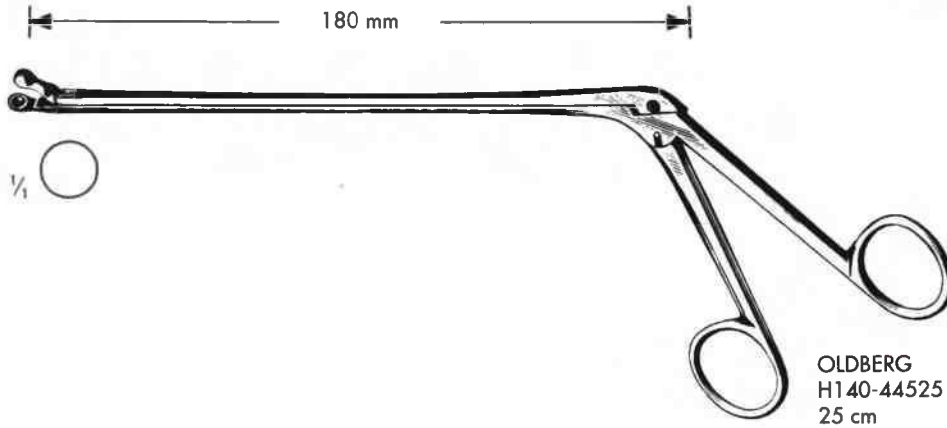

Laminektomie  
Laminectomy  
Laminectomie  
Laminectomía  
Laminectomia

Bandscheiben-Stanzen  
Intervertebral Disc Rongeurs  
Pinces emporte-pièce pour lames intervertébrales  
Pinzas sacabocado para discos intervertebrales  
Pinze taglianti per dischi intervertebrali

140



FERRIS-SMITH-KERRISON  
H140-51001 - H140-51205  
18 cm



H140-51001  
1 mm



H140-51101  
1 mm



H140-51002  
2 mm



H140-51102  
2 mm



H140-51202  
2 mm



H140-51003  
3 mm

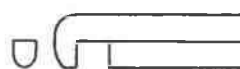

H140-51103  
3 mm



H140-51203  
3 mm



H140-51004  
4 mm



H140-51104  
4 mm



H140-51005  
5 mm



H140-51105  
5 mm



H140-51205  
5 mm

Bandscheiben-Stanzen  
Intervertebral Disc Rongeurs  
Pincas emporte-pièce pour lames intervertébrales  
Pinzas sacabocado para discos intervertebrales  
Pinze taglianti per dischi intervertebrali

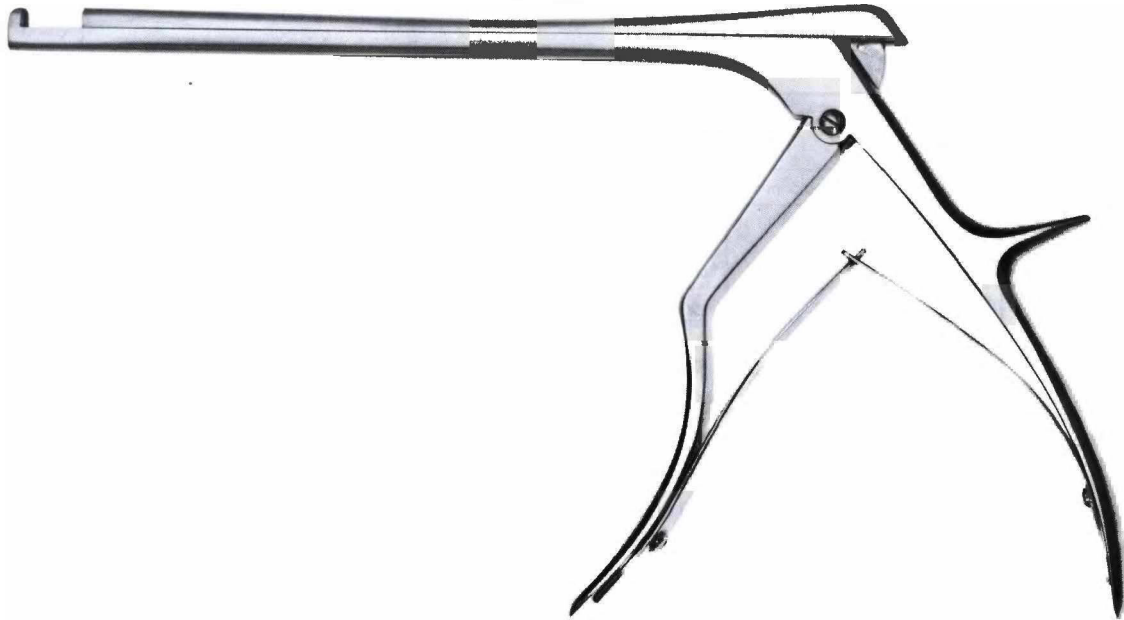

COLCLOUGH  
H140-52003 - H140-52505



L	3 mm
15 cm	H140-52003
20 cm	H140-52203



L	5 mm
15 cm	H140-52005
20 cm	H140-52205



L	3 mm
15 cm	H140-52403
20 cm	H140-52603

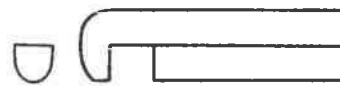

L	5 mm
15 cm	H140-52405
20 cm	H140-52605

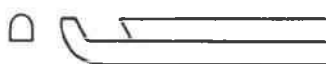

L	3 mm
15 cm	H140-52703
20 cm	H140-52903



















L	5 mm
15 cm	H140-52705
20 cm	H140-52905

Neuro-, Gefäßchirurgie  
Neuro, Vascular Surgery  
Neurochir., Chir. vascul.  
Neurocir., Cir. vascular  
Neurochir., Chir. vascolare

Temporäre Clips = vergoldete Federenden  
Temporary Clips = gold plated spring ends  
Clips temporaires = bouts des ressorts dorés  
Clips temporarios = extremos de los resortes dorados  
Clips temporari = estremo della molla dorato

Clips "Mini"

MINI 	permanent				temporary				
		Maulöffnung Opening Ouverture Abertura Apertura	Maullänge Length of Jaws Longueur des mors Largo de la boca Lunghezza dei morsi	Schließkraft Closing Force Force de fermeture Fuerza de compresión Forza di compressione		Maulöffnung Opening Ouverture Abertura Apertura	Maullänge Length of Jaws Longueur des mors Largo de la boca Lunghezza dei morsi	Schließkraft Closing Force Force de fermeture Fuerza de compresión Forza di compressione	
	H140-57030	3,0 mm	3 mm	100-130 g (0,98-1,28 N)	H140-57130	3,0 mm	3 mm	35-45 g (0,34-0,44 N)	
	H140-57230	3,0 mm	3 mm						
	H140-58035	3,5 mm	5 mm		H140-58135	3,5 mm	5 mm		
	H140-58235	3,5 mm	5 mm		H140-58335	3,5 mm	5 mm		
	H140-58433	3,3 mm	5 mm						
	H140-69030	3,0 mm	3 mm						
	H140-69235	3,5 mm	5 mm						
	H140-69435	3,5 mm	5 mm						
	H140-69633	3,3 mm	5 mm						
	H140-69830	3,0 mm	5 mm						
	H140-71040	4,0 mm	7 mm		H140-71140	4,0 mm	7 mm	40-50 g (0,39-0,49 N)	
	H140-71238	3,8 mm	7 mm		H140-71338	3,8 mm	7 mm		
	H140-71435	3,5 mm	7 mm		H140-71535	3,5 mm	7 mm		
	H140-71850	5,0 mm	7 mm		80-100 g (0,78-0,98 N)				
	H140-76640	4,0 mm	7 mm		100-130 g (0,98-1,28 N)				

Anlegezangen · Applying Forceps · Pincas de pose · Pinzas de aplicación · Pinze per posizionare















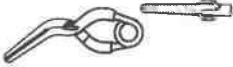







f.p.  
MINI H140-77221  
STANDARD H140-77421  
21 cm

Neuro-, Gefäßchirurgie  
Neuro, Vascular Surgery  
Neurochir., Chir. vascul.  
Neurocir., Cir. vascular  
Neurochir., Chir. vascolare

Clips "Standard"

140

STANDARD 	permanent				temporary				
	Maulöffnung Opening Ouverture Abertura Apertura	Maullänge Length of Jaws Longueur des mors Largo de la boca Lunghezza dei morsi	Schließkraft Closing Force Force de fermeture Fuerza de compresión Forza di compressione			Maulöffnung Opening Ouverture Abertura Apertura	Maullänge Length of Jaws Longueur des mors Largo de la boca Lunghezza dei morsi	Schließkraft Closing Force Force de fermeture Fuerza de compresión Forza di compressione	
	H140-72055	5,5 mm	7 mm	110-140 g (1,08-1,37 N)					
	H140-72253	5,3 mm	7 mm						
	H140-72448	4,8 mm	7 mm						
	H140-72650	5,0 mm	7 mm						
	H140-72868	6,8 mm	7 mm						
	H140-73060	6,0 mm	9 mm			H140-73173	7,3 mm	9 mm	40-50 g (0,39-0,49 N)
	H140-73260	6,0 mm	9 mm			H140-73373	7,3 mm	9 mm	
	H140-73450	5,0 mm	9 mm			H140-73563	6,3 mm	9 mm	
	H140-73875	7,5 mm	9 mm						
	H140-74068	6,8 mm	11 mm						
	H140-74265	6,5 mm	11 mm						
	H140-74458	5,8 mm	11 mm						
	H140-75080	8,0 mm	15 mm		100-130 g (0,98-1,28 N)	*H140-75100	10,0 mm	15,0 mm	60-80 g (0,59-0,78 N)
	H140-75275	7,5 mm	15 mm	*H140-75393		9,3 mm	15,0 mm		
	H140-75465	6,5 mm	15 mm	*H140-75580		8,0 mm	15,0 mm		
	H140-77068	6,8 mm	9 mm	110-140 g (1,08-1,37 N)	*PILOT-Clips				
	H140-78038	3,8 mm	7 mm						
					*H140-76112	12,0 mm	20,0 mm	80-110 g (0,78-0,98 N)	
					*H140-76311	11,5 mm	20,0 mm		



Ophthalmologie  
Ophthalmology  
Ophtalmologie  
Oftalmología  
Oftalmologia

142

Sperrelevatoren  
Eye Specula  
Blépharostats  
Blefarostatos  
Blefarostati

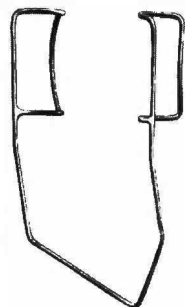

cm **BARRAQUER (Colibri)**  
3 H142-10103  
4 H142-10104

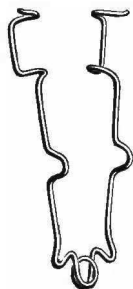

**BOWMAN**  
H142-10407  
7 cm

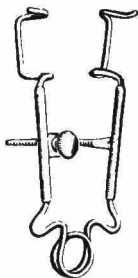

**CRITCHETT**  
H142-10506  
7 cm



**SMITH**  
H142-10605  
5 cm

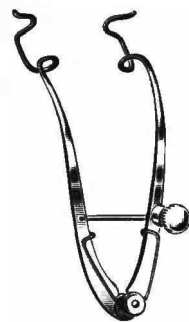

**CLARK**  
H142-10708  
8 cm



cm **GRAEFE**  
7 H142-10906  
9 H142-10907



**WEEK**  
H142-11008  
8 cm

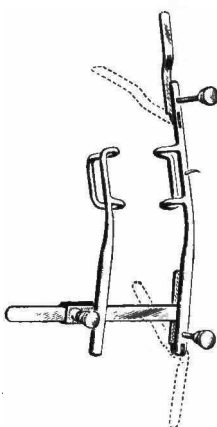

7 cm · rechts  
right · à droite  
a la derecha  
destro

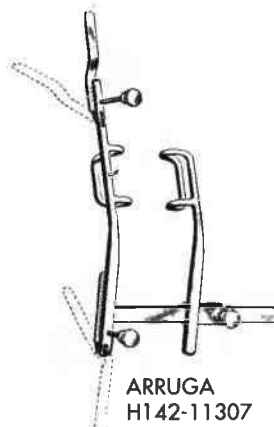

**ARRUGA**  
H142-11307  
7 cm · links  
left · à gauche  
a la izquierda  
sinistro

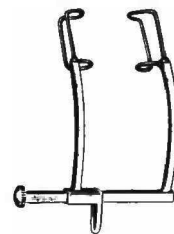

**MURDOCK**  
H142-11505  
5 cm

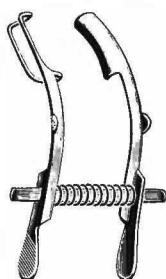

**MELLINGER-AXENFELD**  
H142-12107  
7 cm

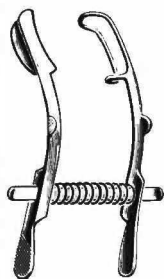

**MELLINGER-AXENFELD**  
H142-12307  
7 cm

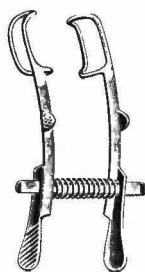

cm **MELLINGER**  
5 H142-12505  
7 H142-12507



**LISTER-BURCH**  
H142-12708  
8 cm



**WILLIAMS**  
H142-12808  
8 cm

Sperrelevatoren  
Eye Specula  
Blépharostats  
Blefarostatos  
Blefarostati



LANCASTER  
H142-12907  
7 cm



ZIEGLER  
H142-13007  
7 cm



CASTROVIEJO  
H142-13208  
8 cm

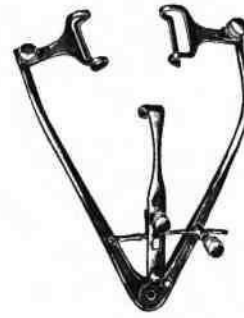

PARK  
H142-13308  
8 cm



MUELLER  
H142-13507  
7 cm



GOLDSTEIN  
H142-13707  
3 cm



STEVENSON  
H142-13907  
7 cm



JAEGER  
H142-15011  
11 cm

Lidplatte  
Lid Plate  
Plaque à paupières  
Placa para párpados  
Placca per palpebre

Starmesser  
Cataract Knives  
Couteaux à cataracte  
Cuchillos para catarata  
Coltelli per cataratta



GRAEFE  
H142-17000 - H142-17003



H142-17000  
Fig. 0



H142-17001  
Fig. 1



H142-17002  
Fig. 2



H142-17003  
Fig. 3



DEUTSCHMANN  
H142-17213  
13 cm

Ophthalmologie  
Ophthalmology  
Ophthalmologie  
Oftalmología  
Oftalmologia

Verschiedene Augenmesser  
Various Eye Knives  
Couteaux oculaires divers  
Cuchillos oculares varios  
Coltelli diversi per oculistica



H142-18001 - H142-21812



**JAEGER**  
H142-18001 Fig. 1    H142-18002 Fig. 2    H142-18003 Fig. 3



**JAEGER 45°**  
H142-18101 Fig. 1    H142-18102 Fig. 2    H142-18103 Fig. 3



**BERENS**  
H142-18313  
13 cm



**CASTROVIEJO**  
H142-18513  
4 x 13 mm  
13 cm



**GRAEFE**  
H142-18713  
13 cm



**KNAPP**  
H142-20201 Fig. 1



H142-20202 Fig. 2



H142-20203 Fig. 3



**ZIEGLER**  
H142-21001 Fig. 1  
5 mm



H142-21002 Fig. 2  
6 mm



H142-21003 Fig. 3  
7 mm



**DEAN**  
H142-21312  
12,5 cm



**BOWMAN**  
H142-21404  
0,4 mm  
13 cm



H142-21408  
0,8 mm  
13 cm



**WHEELER**  
H142-21812  
12 cm

Verschiedene Augenmesser, Fremdkörper-Instrumente, Hornhaut-Schaber und -Dissektoren, Star- und Fremdkörper-Nadeln, Sklerotome, Fixiergabel.

Various Eye Knives, Foreign Body Instruments, Corneal Scarifiers and Dissectors, Cataract and Foreign Body Needles, Sclerotomes, Fixation Fork.

Divers couteaux oculaires, Instruments à corps étrangers, Scarificateurs et dissecteurs cornéens, Aiguilles à cataracte et à corps étrangers, Sclérotomes, Fourchette à fixation.

Cuchillos oculares varios, Instrumentos para cuerpos extraños, escarificadores y disecadores para la córnea, Aguja para catarata y para cuerpos extraños, Horquilla de fijación.

Cotelli oculistici diversi, Strumenti per corpi estranei, Scarificatori e scollatori per la cornea, Aghi per cataratta e per corpi estranei, Forchetta di fissaggio.



ZIEGLER  
H142-22111  
11 cm, 3,5 mm



SATO  
H142-22612  
12,5 cm



TOOK  
H142-22812  
12 cm



GILL  
H142-23112  
12 cm



ELSCHNIG  
H142-23313  
13 cm



KUHNT  
H142-24001  
Fig. 1



KUHNT  
H142-24002  
Fig. 2



KUHNT  
H142-24003  
Fig. 3



KUHNT  
H142-24004  
Fig. 4



PATON  
H142-24512  
12 cm



LUNDSGAARD  
H142-25112  
12 cm



GUYTON-  
LUNDSGAARD  
H142-25312



BARRKAN  
H142-25612



SCHIE  
H142-25812



BURCH  
H142-26212



PAUFIQUE  
H142-27111



BARRAQUER  
H142-27313



H142-30412



H142-30512



BOWMAN  
H142-30812



BOWMAN  
H142-30912



H142-31013



H142-31113



LEVINSON  
H142-31413



FRANCIS  
H142-32112



DAVIS  
H142-32513  
13 cm

Ophthalmologie  
Ophthalmology  
Ophthalmologie  
Oftalmología  
Oftalmologia

Fremdkörper-Instrumente, Hornhaut-Dissektor, Extirpations-Meißel, Schiel-, Muskel-, Linsen-, Extraktionshaken, Iris-, Wundhäkchen, Cystotome.

Foreign Body Instruments, Corneal Dissector, Extirpation Chisel, Strabismus, Muscle, Lens, and Extraction Hooks, Iris and Delicate Retractors, Cystotomes.

Instruments à corps étrangers, Dissecteur cornéen, Ciseaux à extirpation, Crochets à strabisme, musculaires, pour la lentille, à extraction et à iris, Kystitomes.

Instrumentos para cuerpos extranjeros, Disecador corneal, Cíncel de extirpación, Ganchos para estrabismo, musculares, para el cristalino y de extracción, Ganchitos para iris, separadores finos.

Strumenti per corpi estranei, Scollatore corneale, Scalpelli per estirpazione, Uncini per strabismo, muscolare, per cristallino e per estrazione, Uncini per iride, Divaricatori fini, Cistitomi.

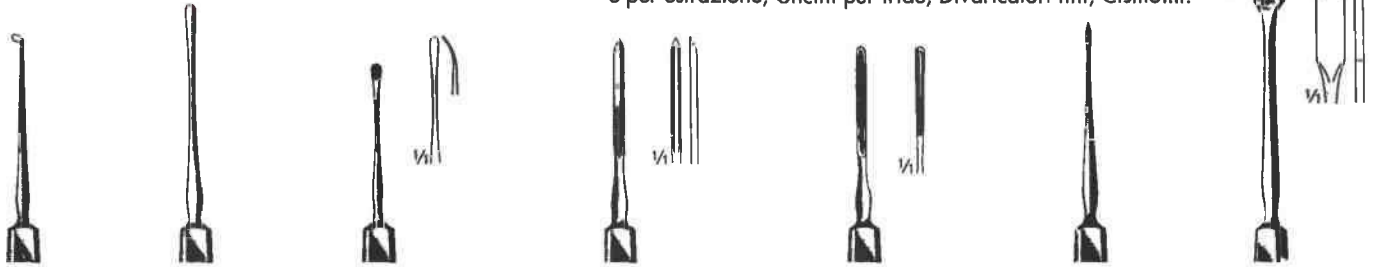

LA FORCE  
H142-32712

DIX  
H142-33013

ELLIS  
H142-33111

WALTON  
H142-33212

WALTON  
H142-33412

ALVIS  
H142-33612

GREEN  
H142-34013

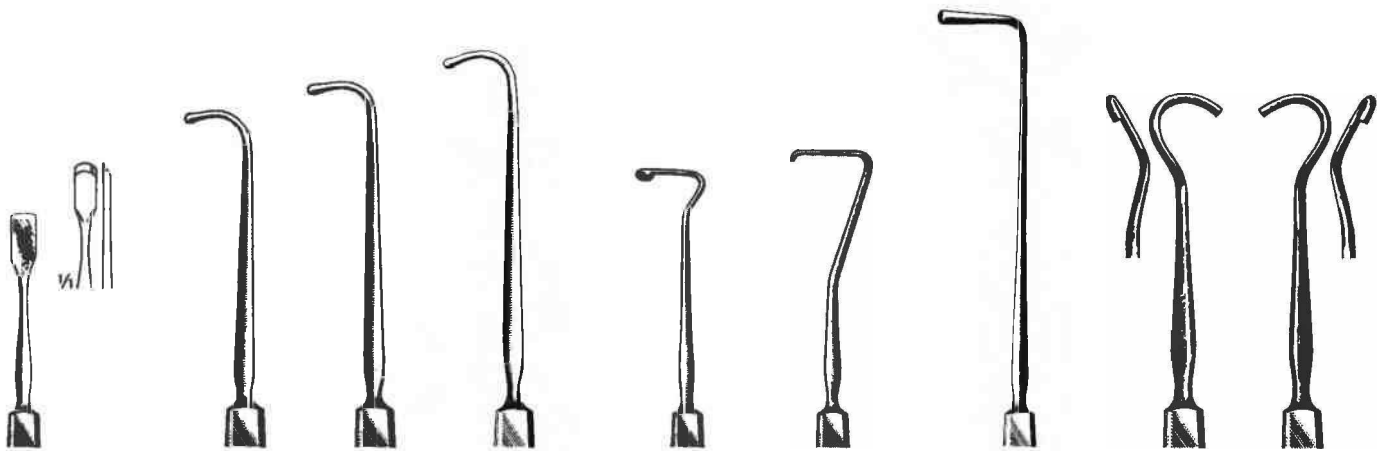

ROLLET  
H142-34212

GRAEFE  
H142-35101 H142-35102 H142-35103  
H142-35201 H142-35202 H142-35203

Fig. 1

Fig. 2

Fig. 3

JAMESON  
H142-35313

GREEN  
H142-35513

STEVENS  
H142-35713

ARRUGA  
H142-36301 H142-36302

Fig. 1

Fig. 2

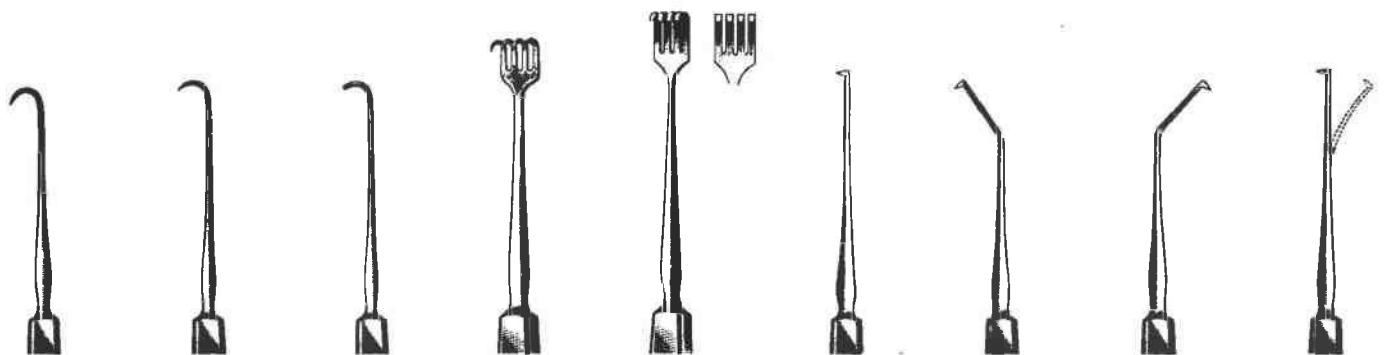

O'CONNOR  
H142-37012

WIENER  
H142-37213

WIENER  
H142-37313

ROLLET  
H142-37613

KNAPP  
H142-37713

H142-38013

GRAEFE  
H142-38113

H142-38313

BECKER  
H142-38613



Chalazions-, Star-, Exenterations-Löffel.  
Scoops and Curettes for Chalazion, Cataract, and Exenteration.  
Curettes et cuillers pour chalazion, cataracte et exentération.  
Curetas y cucharillas para chalazión, catarata y exenteración.  
Curette e cucchiari per calazio, cataratta e palpebre.

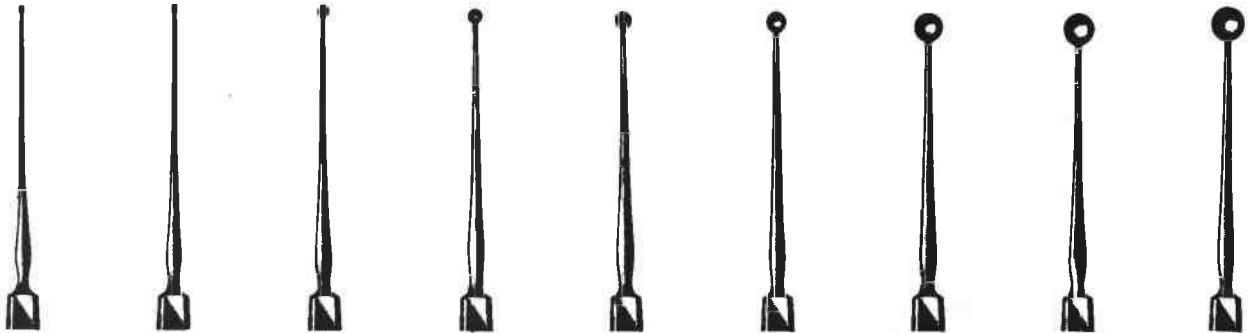

MEYHOEFER

	H142-40205	H142-40210	H142-40215	H142-40218	H142-40220	H142-40225	H142-40235	H142-40240	H142-40245
Ø mm	0,5	1,0	1,5	1,8	2,0	2,5	3,5	4,0	4,5
	13 cm								

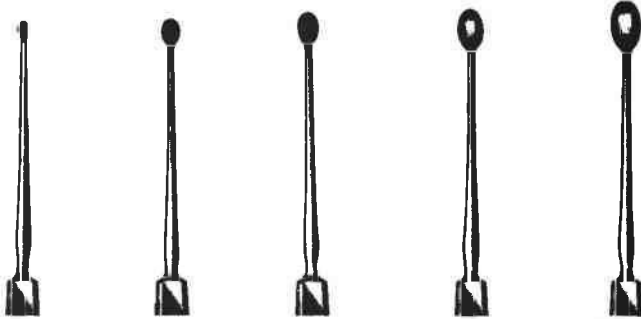

HEBRA

	H142-40410	H142-40420	H142-40425	H142-40430	H142-40435
Ø mm	1,0	2,0	2,5	3,0	3,5
	13 cm				



AXENFELD  
H142-40713

Ø 2,8 mm      Ø 3,3 mm

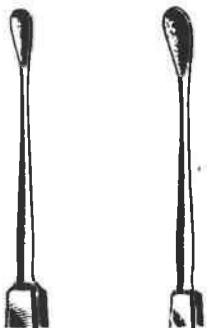

GRAEFE

H142-41001	H142-41002
13 cm	

Ø 2,5 mm      Ø 3 mm

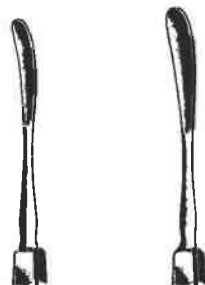

DAVIEL

H142-41201	H142-41202
12,5 cm	

Ø 6,2 mm



KNAPP

H142-41402
13,5 cm

Ø 8 mm



H142-42001

Ø 9 mm



BUNGE

H142-42002
13,5 cm

Ø 10 mm



H142-42003

Ophthalmologie  
Ophthalmology  
Ophtalmologie  
Ofthalmología  
Ofthalmologia

142

Drahtschlingen  
Wire Loops  
Anses  
Asas  
Anse

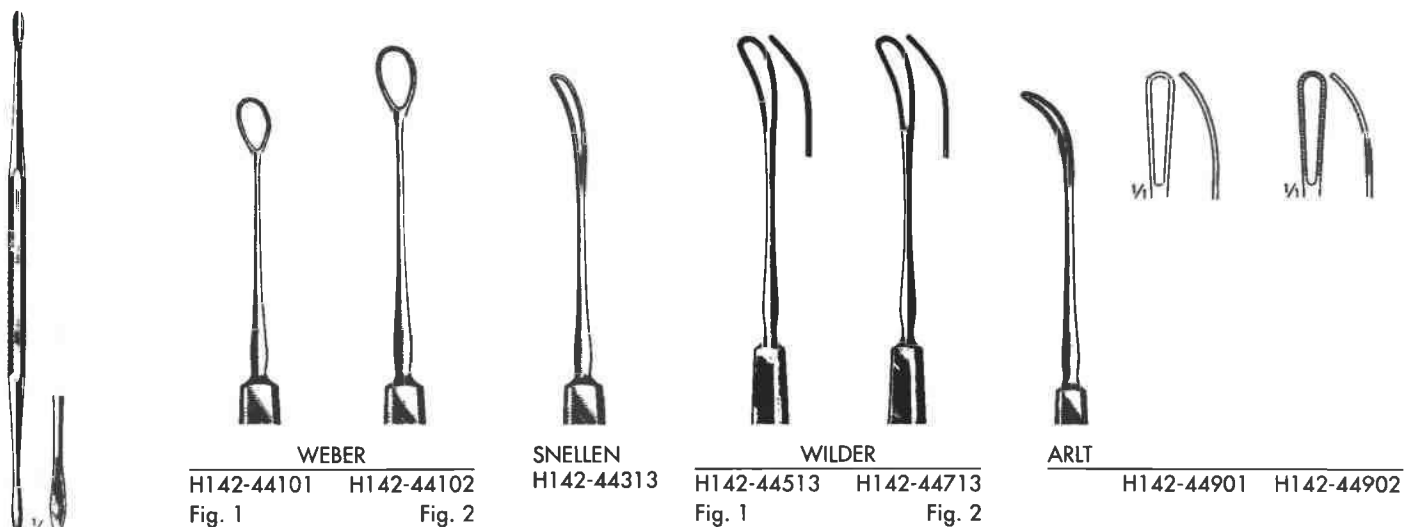

LANG  
H142-42413

WEBER  
H142-44101 H142-44102  
Fig. 1 Fig. 2

SNELLEN  
H142-44313

WILDER  
H142-44513 H142-44713  
Fig. 1 Fig. 2

ARLT  
H142-44901 H142-44902

Iris · Iride

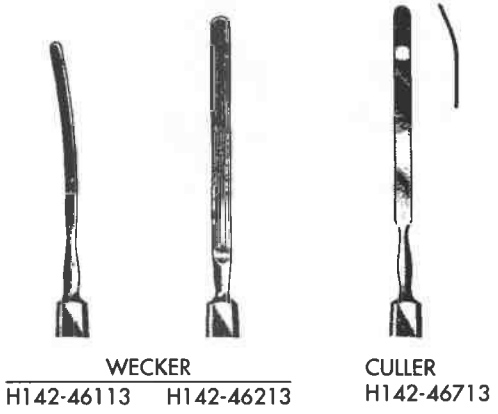

WECKER  
H142-46113 H142-46213

CULLER  
H142-46713



WELLS  
H142-48220



ARRUGA  
H142-48513

Kauter · Cauter  
Cautère · Cauterio



WADSWORTH-TODD  
H142-48714

Zyklodialyse · Cyclodialysis · Cyclodialyse · Ciclodíalisis · Ciclodialisi

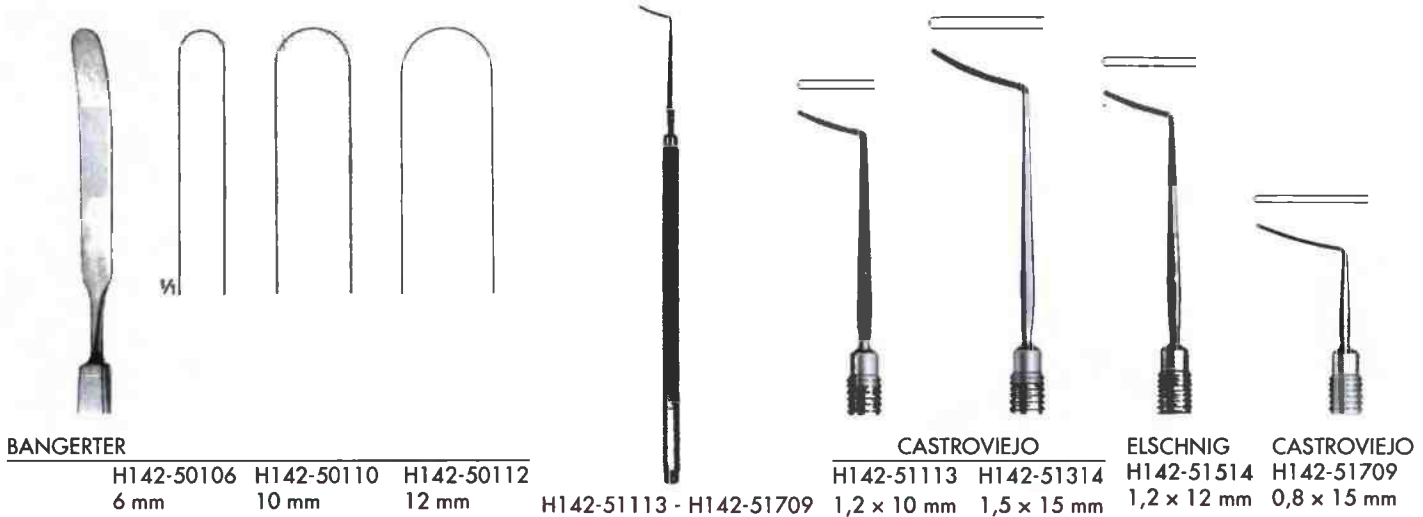

BANGERTER  
H142-50106 H142-50110 H142-50112  
6 mm 10 mm 12 mm

H142-51113 - H142-51709  
CASTROVIEJO  
H142-51113 H142-51314  
1,2 x 10 mm 1,5 x 15 mm

ELSCHNIG CASTROVIEJO  
H142-51514 H142-51709  
1,2 x 12 mm 0,8 x 15 mm

Zyklodialyse-Spatel, Fremdkörper-Instrumente  
Cyclodialysis Spatulae, Foreign Body Instruments  
Spatules à cyclodialyse, Instruments à corps étrangers  
Espátulas para ciclodiálisis, Instrumentos para cuerpos extraños  
Spatole per ciclodialisi, Strumenti per corpi estranei



CASTROVIEJO  
H142-52112

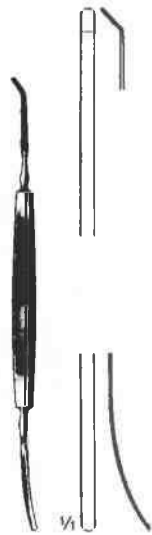

WHEELER  
H142-52312



mm	CASTROVIEJO
0,5	H142-52505
0,75	H142-52507
1,0	H142-52510



DIX  
H142-54212



DIX  
H142-54412

Markier-Instrumente  
Markers  
Marqueurs  
Marcadores  
Marcatori



DIX  
H142-54613



DIX  
H142-54813

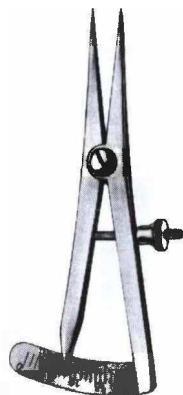

CASTROVIEJO  
H142-58307  
0-20 mm



CONNIN-AMSLER  
H142-58913



DASTOOR  
H142-59006  
6 cm

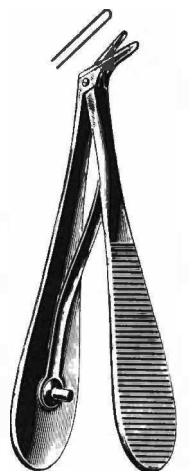

HOLTH  
H142-59309

Ophthalmologie  
Ophthalmology  
Ophtalmologie  
Oftalmología  
Oftalmologia

142

Tränengang-Dilatatoren  
Lachrymal Dilators  
Dilatateurs pour canal lacrymal  
Dilatadores para canal lacrimal  
Dilatatori per canale lacrimale

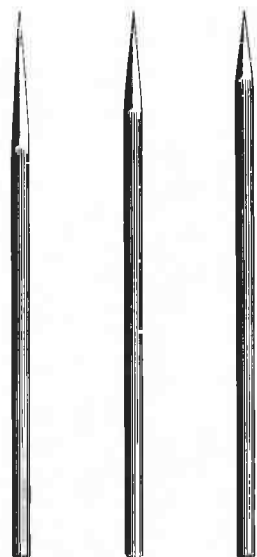

**WILDER**  
H142-60201 H142-60202 H142-60203



**Fig. ZIEGLER**  
1/2 H142-60512  
3/4 H142-60534  
5/6 H142-60556



**CASTROVIEJO**  
H142-60812

Tränenkanal-Sonden  
Lachrymal Probes  
Stylets pour le canal lacrymal  
Estiletos para canal lacrimal  
Specilli per canale lacrimale



BOWMAN	Fig.	BOWMAN
H142-61400	00/0	H142-61600
H142-61401	0/1	H142-61601
H142-61412	1/2	H142-61612
H142-61423	2/3	H142-61623
H142-61434	3/4	H142-61634
H142-61445	4/5	H142-61645
H142-61456	5/6	H142-61656
H142-61467	6/7	H142-61667
H142-61478	7/8	H142-61678

**Fig.** 00 0 1 2 3 4 5 6 7 8  
Ø mm 0,7 0,8 0,9 1,1 1,3 1,4 1,5 1,6 1,8 1,9

Iris-Pinzetten · Iris Forceps  
Pincas à iris · Pinzas para iris · Pinze per iride



**GRAEFE**  
H142-80207  
7 cm/1 mm

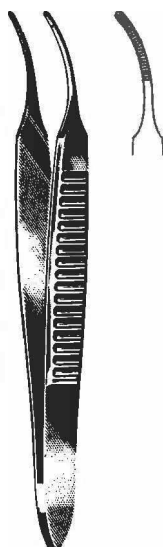

**GRAEFE**  
H142-80307  
7 cm/1 mm



**GRAEFE**  
H142-80407  
7 cm/1 mm

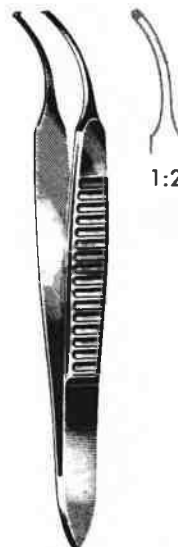

**GRAEFE**  
H142-80507  
7 cm/1 mm

Iris-Pinzetten  
Iris Forceps  
Pincès à iris  
Pinzas para iris  
Pinze per iride



GRAEFE  
H142-81010  
10 cm



GRAEFE  
H142-81110  
10 cm



GRAEFE  
H142-81310  
10 cm



GRAEFE  
H142-82010  
10 cm



GRAEFE  
H142-82110  
10 cm



GRAEFE  
H142-82310  
10 cm



STEVENS  
H142-83010  
10,5 cm



STEVENS  
H142-83110  
10,5 cm



STEVENS  
H142-83310  
10,5 cm



STEVENS  
H142-84010  
10,5 cm



STEVENS  
H142-84110  
10,5 cm



STEVENS  
H142-84310  
10,5 cm



Iris-Pinzetten  
Iris Forceps  
Pinces à iris  
Pinzas para iris  
Pinze per iride

142

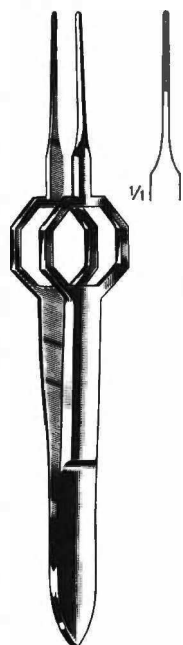

FOERSTER  
H142-85008  
8,5 cm

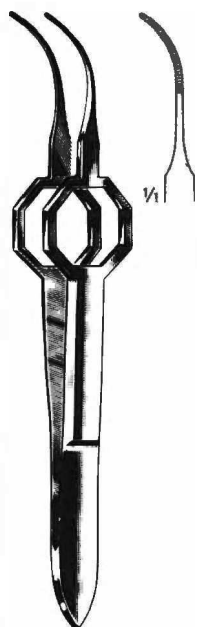

FOERSTER  
H142-85108  
8,5 cm

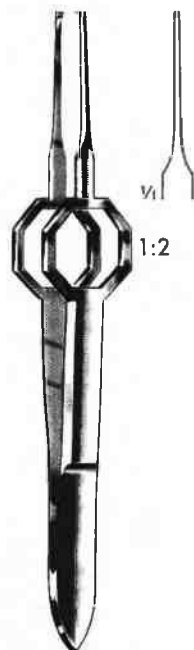

FOERSTER  
H142-85208  
8,5 cm

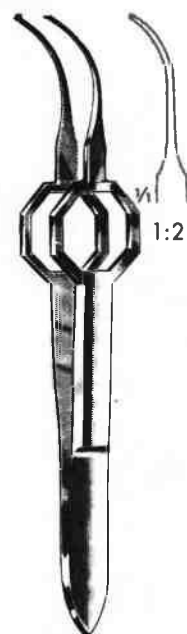

FOERSTER  
H142-85308  
8,5 cm

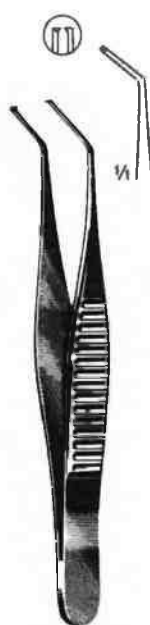

HESS  
H142-85507  
7 cm/0,3 mm

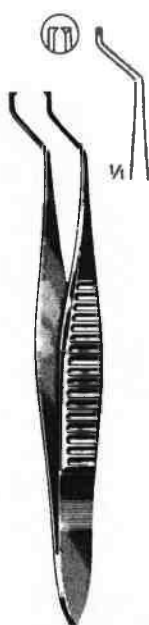

HESS  
H142-85707  
7 cm/0,3 mm



GILL  
H142-86107  
7,5 cm/0,3 mm

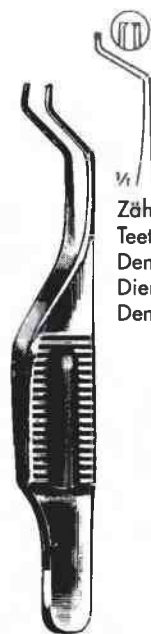

GILL-HESS  
H142-86307  
7,5 cm/0,3 mm

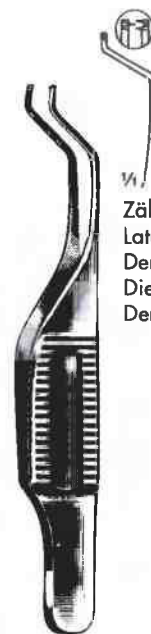

GILL-HESS  
H142-86507  
7,5 cm/0,3 mm

Zähne unten  
Teeth below  
Dents en bas  
Dientes abajo  
Denti in basso

Zähne seitwärts  
Lateral Teeth  
Dents latérales  
Dientes laterales  
Denti laterali

Iris-, Strabismus-Pinzetten  
Iris, Strabismus Forceps  
Pincès à iris et à strabisme  
Pinzas para iris y para estrabismo  
Pinze per iride e per strabismo

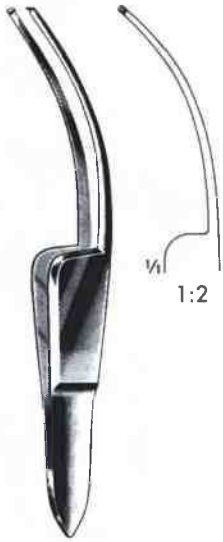

FISCHER  
H142-86907  
7 cm



BARRAQUER-KATZIN  
H142-88107  
7 cm/0,4 mm



TROUTMAN (Colibri)  
H142-88307  
7 cm/0,12 mm

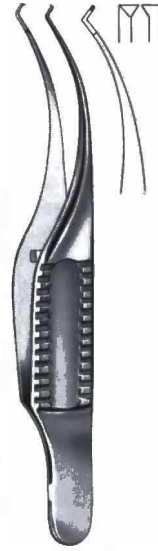

BARRAQUER (Colibri)  
H142-88507  
7 cm/0,12 mm

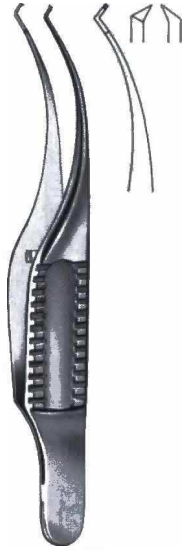

BARRAQUER (Colibri)  
H142-88707  
7 cm/0,12 mm



KIRBY-ARTHUR  
H142-89109  
9 cm/0,2 mm



KIRBY-ARTHUR  
H142-89309  
9 cm/0,2 mm



McCULLOUGH  
H142-90209  
9,5 cm



McCULLOUGH  
H142-90409  
9,5 cm

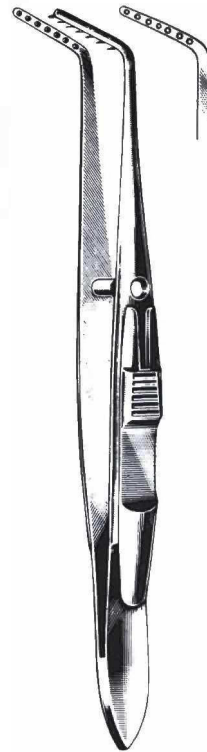

JAMESON  
H142-90710  
L, 10 cm



JAMESON  
H142-90910  
R, 10 cm

Ophthalmologie  
Ophthalmology  
Ophtalmologie  
Ofthalmología  
Ofthalmologia

Strabismus-Pinzetten  
Strabismus Forceps  
Pincès à strabisme  
Pinzas para estrabismo  
Pinze per strabismo



BONACCOLTO  
H142-91410  
10 cm



BONACCOLTO  
H142-91610  
10 cm



BONACCOLTO  
H142-92011  
11 cm



DASTOOR  
H142-92411  
11 cm



DASTOOR  
H142-92611  
11 cm



BISHOP-HARMAN  
H142-94005  
8,5 cm/0,5 mm



BISHOP-HARMAN  
H142-94008  
8,5 cm/0,8 mm



BISHOP-HARMAN  
H142-94205  
8,5 cm/0,5 mm



BISHOP-HARMAN  
H142-94208  
8,5 cm/0,8 mm



Iris-Pinzetten · Iris Forceps · Pincès à iris  
Pinzas para iris · Pinze per iride



Mod. BONN  
H142-94407  
7 cm/0,12 mm



Mod. BONN  
H142-94607  
7 cm/0,12 mm



Iris-, Muskel-Pinzetten  
Iris, Muscle Forceps  
Pincès à iris, musculaires  
Pinzas para iris, musculares  
Pinze per iride, muscolari

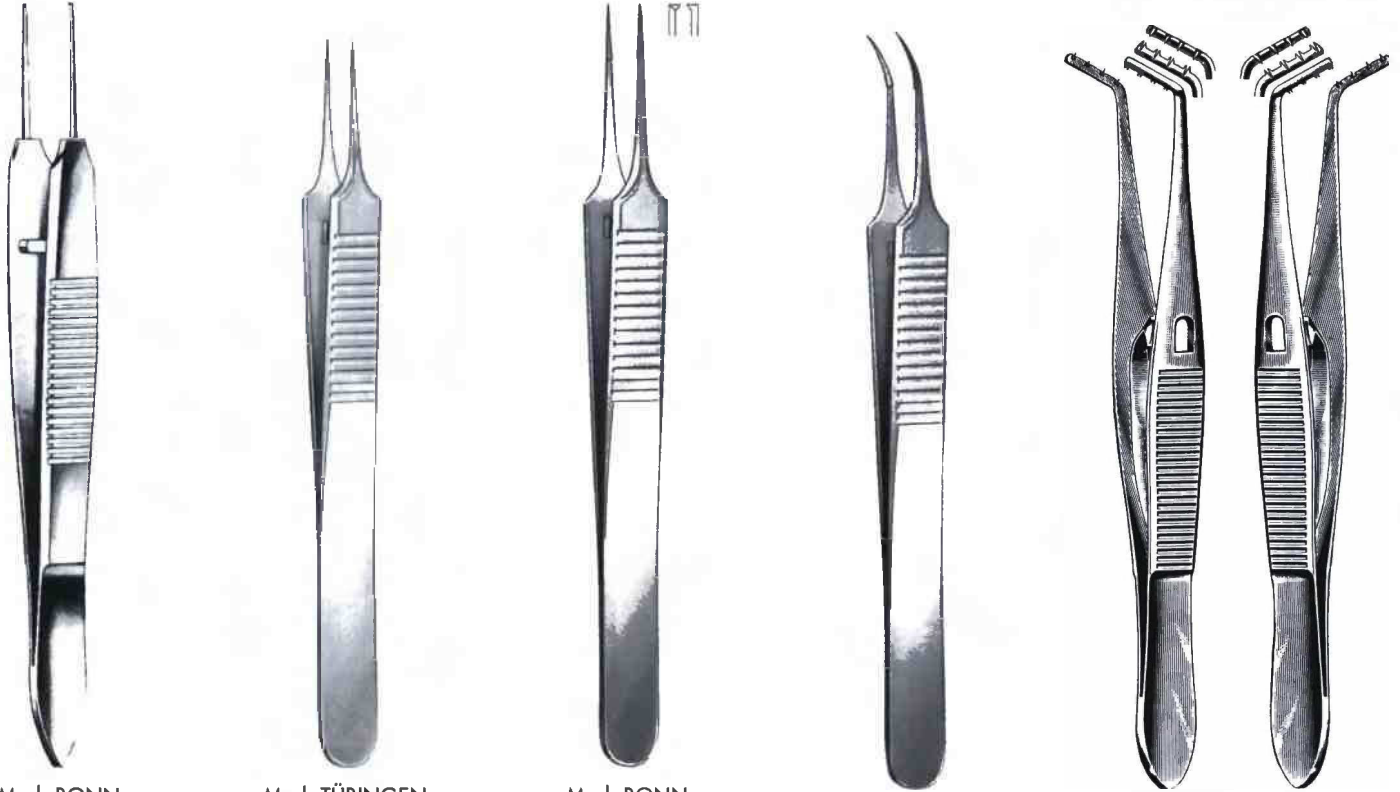

Mod. BONN  
H142-94610  
10 cm/0,12 mm

Mod. TÜBINGEN  
H142-95010  
H142-95410  
10 cm

Mod. BONN  
H142-95210  
H142-95610  
10 cm/0,12 mm

Mod. TÜBINGEN  
H142-95310  
H142-95710  
10 cm

PRINCE  
H143-01110  
10 cm

PRINCE  
H143-01310  
10 cm

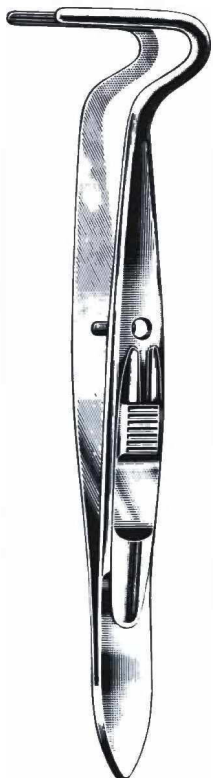

BERKE  
H143-01520 - H143-01527

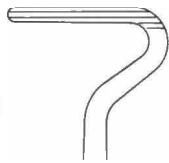

H143-01520

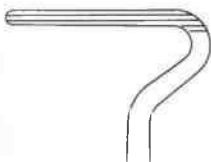

H143-01527

Rectus



TROUTMAN  
H143-01708  
8,5 cm/0,8 mm

Vorderkammer-Pinzette  
Anterior Chamber Forceps  
Pince à chambre antérieure  
Pinza para cámara anterior  
Pinza per camera anteriore

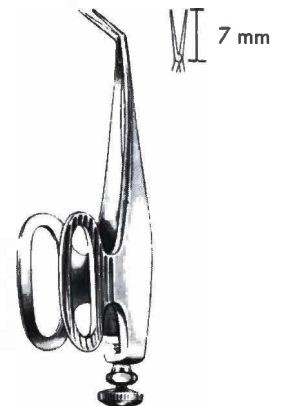

BARRAQUER  
H143-02105  
5,5 cm/7 mm



Ophthalmologie  
Ophthalmology  
Ophthalmologie  
Oftalmología  
Oftalmologia

Fixier-Pinzetten, Kapsel-Pinzette  
Fixation Forceps, Capsular Forceps  
Pincés à fixation, pince capsulaire  
Pinzas para fijación, pinza capsular  
Pinze per fissaggio, pinza capsulare

143



ELSCHMIG  
H143-04611  
11 cm



GRAEFE  
H143-05011 - H143-05211



LESTER  
H143-05409  
9 cm



CASTROVIEJO  
H143-06609



CASTROVIEJO  
H143-06709



CASTROVIEJO  
H143-06809



CASTROVIEJO  
H143-06909



BARRAQUER  
H143-07410  
10 cm

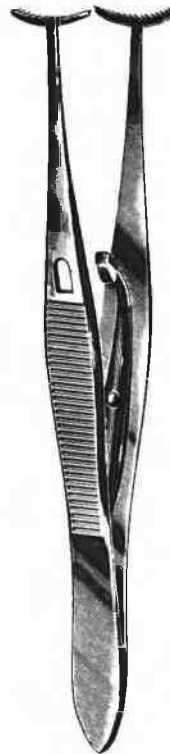

GREEN  
H143-07605 - H143-07810  
10 cm



H143-07605 5 mm  
ohne/without/sans/sin/senza



H143-07610 10 mm

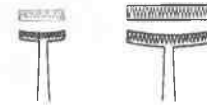

H143-07805 5 mm  
mit/with/avec/con



H143-07810 10 mm

Schloß/catch/crémaillère/  
cierre/cremagliera

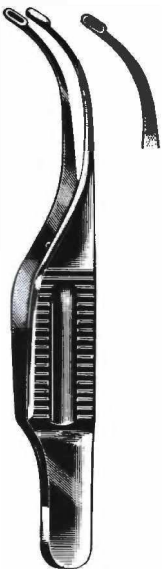

GILL-ARRUGA  
H143-10107  
7,5 cm



Kapsel-Pinzetten  
Capsular Forceps  
Pinces capsulaires  
Pinzas capsulares  
Pinze capsulare



TERSON  
H143-10309  
9 cm



KALT  
H143-10610  
10 cm



ELSCHMIG  
H143-10910  
10 cm



ARRUGA  
H143-11110  
10 cm



ARRUGA  
H143-11410  
10 cm



CASTROVIEJO  
H143-11510  
10 cm



SCHWEIGGER  
H143-11710  
10 cm



SCHWEIGGER  
H143-11910  
10 cm



ELSCHMIG  
H143-12110  
10 cm



HESS  
H143-12506  
6 cm

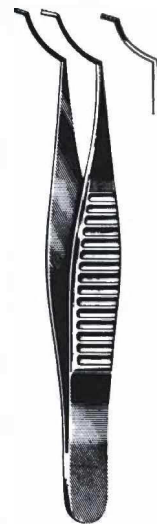

HESS  
H143-12706  
6,5 cm



FUCHS  
H143-12907  
7 cm

Ophthalmologie  
Ophthalmology  
Ophthalmologie  
Oftalmología  
Oftalmologia

143

Naht-, Faden-Pinzetten  
Suturing, Ligature Forceps  
Pinces à sutures et à ligature  
Pinzas para suturas y para ligaduras  
Pinze per sutura e per legatura



CASTROVIEJO

Zahn  
tooth  
dent  
diente  
dente

0,12 mm	H143-15001	
0,30 mm	H143-15003	
0,50 mm	H143-15005	H143-15105
1,00 mm	H143-15010	H143-15110
1,50 mm	H143-15015	H143-15115



MOORFIELD  
H143-16410  
10 cm



St. MARTIN  
H143-16607  
7 cm



Mod. TÜBINGEN  
H143-18110  
H143-18510  
10 cm



PAUFIQUE  
H143-19008  
H143-19408  
8,5 cm



PAUFIQUE  
H143-20208  
H143-20608  
8,5 cm



McPHERSON  
H143-21010  
H143-21410  
10 cm



McPHERSON  
H143-22010  
H143-22410  
10 cm

Pinzetten für Chalazion, Entropium, Trachom  
Forceps for Chalazio, Entropium, Trachoma  
Pincas à chalazion, à entropion, à granulations du trachome  
Pinzas de chalazión, de entropión y para tracoma  
Pinze per calazio, per entropio e per trichiasi

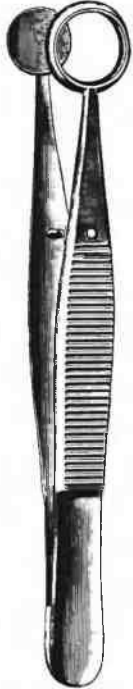

AYER  
H143-24009  
9 cm



AYER  
H143-24209  
9 cm

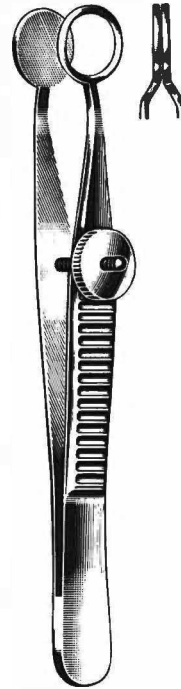

LAMBERT  
H143-24609  
9 cm



DESMARRES  
H143-25409 - H143-25809  
9 cm

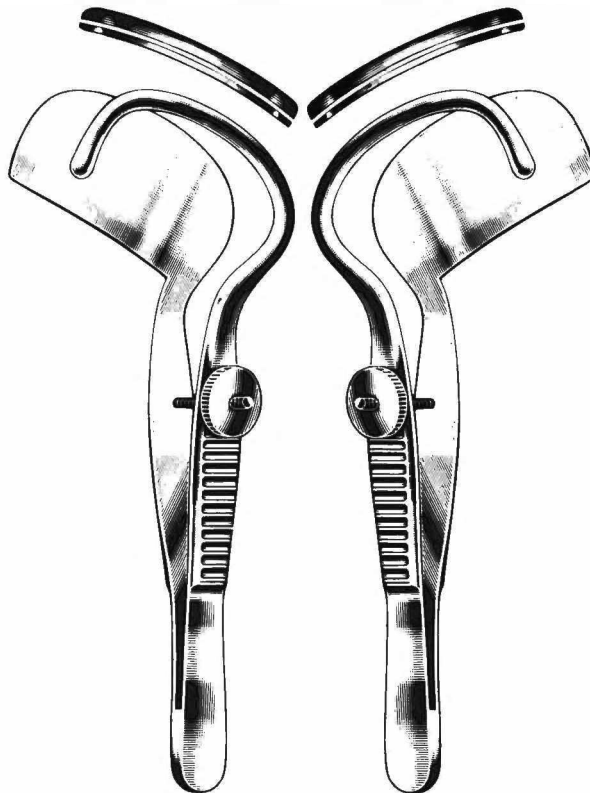

SNELLEN  
H143-26510  
10 cm

SNELLEN  
H143-26710  
10 cm

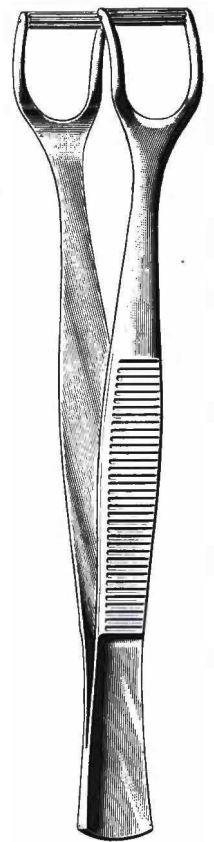

KNAPP-LUER  
H143-27411  
11 cm

Ophthalmologie  
Ophthalmology  
Ophthalmologie  
Oftalmología  
Oftalmologia

143

Augen-Kanülen  
Eye Cannula  
Canules oculaires  
Cánulas oculares  
Cannule oculistique



SCHEIE  
H143-30228  
1,0 x 28 mm

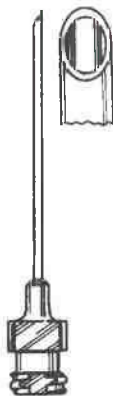

SCHEIE  
H143-30233  
1,5 x 33 mm



Mod. TÜBINGEN  
H143-30345



Mod. HAMBURG  
H143-30500



SIMCOE  
H143-30600



Mod. BONN  
H143-30700



Mod. BONN  
H143-30900

Hornhaut-Trephinen · Corneal Trephines  
Trépan cornéens · Trépanos corneales  
Trefine corneali

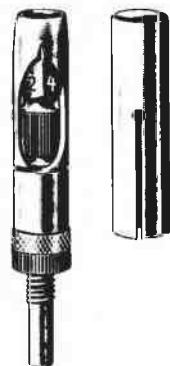

CASTROVIEJO  
H143-31050 - H143-31101

Ø mm	CASTROVIEJO
5,0	H143-31050
5,5	H143-31055
6,0	H143-31060
6,5	H143-31065
7,0	H143-31070
8,0	H143-31080
9,0	H143-31090
10,0	H143-31100
11,0	H143-31101



FRANCESCHETTI  
H143-32050 - H143-32100

Ø mm	FRANCESCHETTI
5,0	H143-32050
5,1	H143-32051
6,0	H143-32060
6,1	H143-32061
7,0	H143-32070
7,1	H143-32071
8,0	H143-32080
8,1	H143-32081
9,0	H143-32090
9,1	H143-32091
10,0	H143-32100

Tonometer · Tonómetro · Tonomètre



SCHIOETZ  
H143-40400 H143-40600

Skala	gerade	schräg
scale	straight	oblique
échelle	droite	oblique
escala	recta	oblicua
scala	retta	obliqua



H143-40800

Augen-Magnet  
Eye Magnet  
Aimant à corps étrangers  
Imán para cuerpos extráneos  
Calamita per corpi estranei

Cilien-Pinzetten  
Cilia Forceps  
Pincas à épiler les cils  
Pinzas depilatorias  
Pinze depilatorie

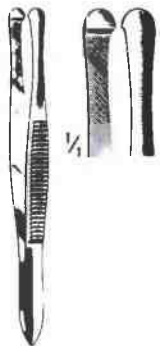

BEER  
H143-42009  
9 cm

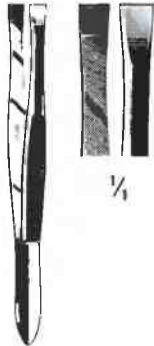

DOUGLAS  
H143-42209  
9 cm



LITTAUER  
H143-42408  
8,5 cm



BARRAQUER  
H143-42510  
10,5 cm

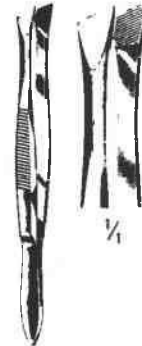

H143-42609  
9 cm

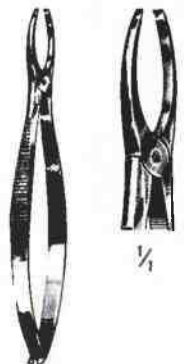

GRADLE  
H143-42809  
9,5 cm



Otologie  
Otology  
Otologie  
Otología  
Otologia

Ohr-Spekula  
Ear Specula  
Spéculums auriculaires  
Espéculos auriculares  
Specoli auricolari

mm Ø  
① = 3  
H144-01030

① = 4,5  
H144-01045

② = 5,5  
H144-01055

③ = 6,5  
H144-01065

④ = 7,5  
H144-01075

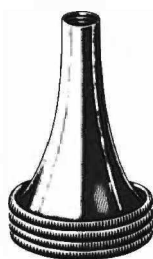

HARTMANN  
H144-01000  
Set = 4



TOYNBEE  
H144-01200  
Set = 3

② mm Ø  
= 5,5  
H144-01255

③ = 6,5  
H144-01265

④ = 7,5  
H144-01275



GRUBER  
H144-01400  
Set = 4

① mm Ø  
= 4,5  
H144-01445

② = 5,5  
H144-01455

③ = 6,5  
H144-01465

④ = 7,5  
H144-01475



GRUBER  
H144-01500  
Set = 3

mm Ø  
① = 4,5  
H144-01545

② = 5,5  
H144-01555

③ = 6,5  
H144-01565

④ = 7,5  
H144-01575

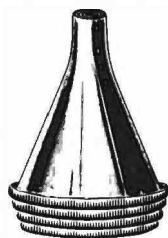

BOUCHERON  
H144-01800  
Set = 4

⑤ H144-01850  
5 mm

⑥ H144-01860  
6 mm

⑦ H144-01870  
7 mm

⑧ H144-01880  
8 mm

①  
6,5



②  
7



③  
8 mm Ø

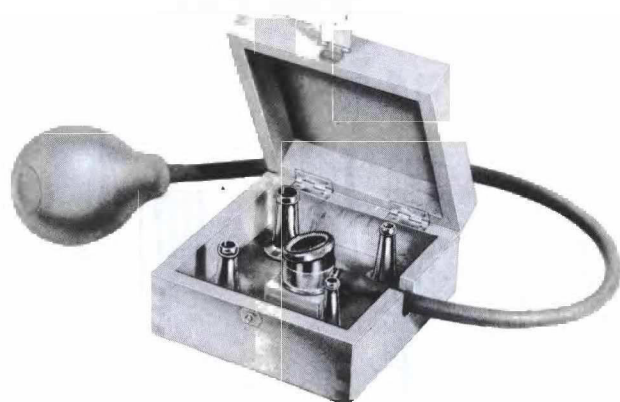

BRUENINGS  
H144-03004  
compl.



SIEGLE  
H144-03603  
compl.



DIMEDA Alu

H144-06001	H144-06002	H144-06003	H144-06004	H144-06005
C 128	C' 256	C <sup>2</sup> 512	C <sup>3</sup> 1024	C <sup>4</sup> 2048



DIMEDA Alu  
H144-06100  
compl.



HARTMANN

H144-07001	H144-07002	H144-07003	H144-07005	H144-07004
C 128	C' 256	C <sup>2</sup> 512	C <sup>4</sup> 2048	C <sup>3</sup> 1024



Otologie  
Otology  
Otologie  
Otología  
Otologia

144



LUCAE  
H144-07401  
C 128

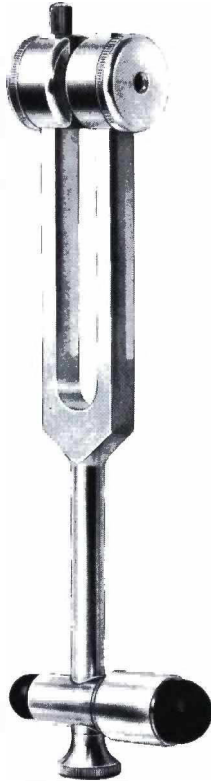

H144-07500  
neuro.



RYDEL-SEIFFER  
H144-07601  
C 64/c 128

Lärmapparat  
Noise Apparatus  
Assourdisseur  
Ensordecedor  
Assordatore



BARANY  
H144-08000

Pulverhläser

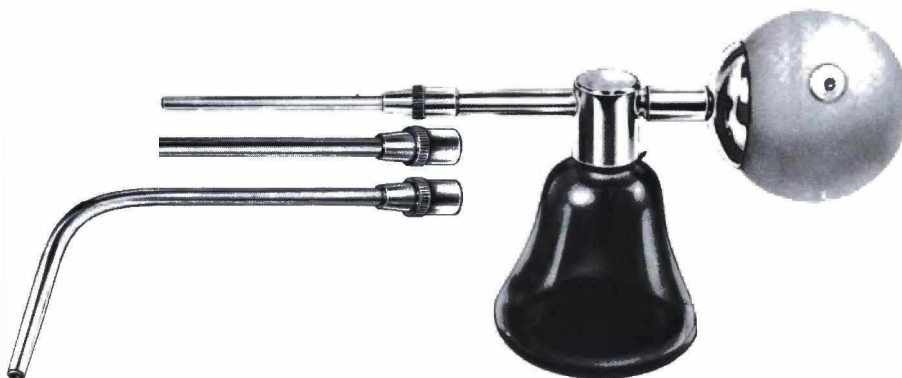

KABIERSKE  
H144-09000  
30 cc

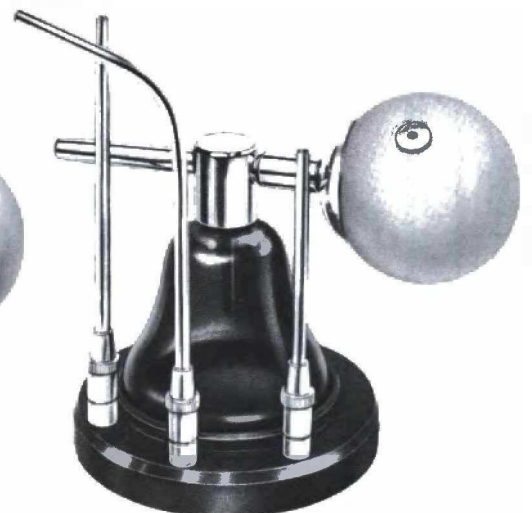

KABIERSKE  
H144-09001  
30 cc

Luftdusche, Ohrspritze  
Air Bag, Ear Syringe  
Insufflateur d'air, Seringue  
Insuflador de aire, Jeringa  
Insuffiatore d'aria, Siringa



H144-09103



H144-09104  
4 mm Ø



H144-09115  
15 mm Ø



H144-09117  
17 mm Ø



H144-09122  
22 mm Ø

**POLITZER**

H144-09100 = incl. H144-09115, H144-09117, H144-09122, H144-09103

H144-09101 = incl. H144-09115, H144-09117, H144-09122, H144-09103, H144-09104

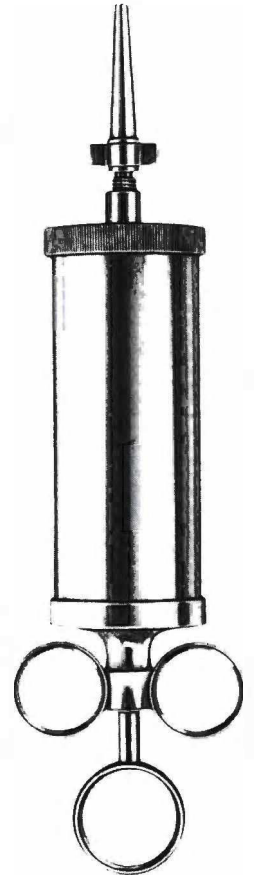

ml	REINER
50	H144-09650
75	H144-09675
100	H144-09710
150	H144-09715

**Küretten**  
Curettes  
Curettes  
Curetas  
Curette



Fig. 00



0



1



2



3



4



5

stumpf · blunt  
mousses  
romas  
smusse



H144-10900

H144-11000

H144-11001

H144-11002

H144-11003

H144-11004

H144-11005

Scharf · sharp  
tranchantes  
coriantes  
taglianti



H144-11100

H144-11200

H144-11201

H144-11202

H144-11203

H144-11204

H144-11205

stumpf · blunt  
mousses  
romas  
smusse



H144-11400

H144-11500

H144-11501

H144-11502

H144-11503

H144-11504

H144-11505

Scharf · sharp  
tranchantes  
coriantes  
taglianti



H144-11600

H144-11700

H144-11701

H144-11702

H144-11703

H144-11704

H144-11705

Otologie  
Otology  
Otologie  
Otología  
Otologia

144

Katheter, Parazentesenadeln, Ohrmesser, Ohrlöffel  
Catheters, Paracentesis Needles, Ear Knives, Ear Spoons  
Sondes, Aiguilles à paracentèse, Couteaux auriculaires, Cuillers  
Cateteres, Aguja para paracentesis, Cuchillos auriculares, Cucharas  
Cateteri, Aghi per paracentesi, Coltelli auricolari, Cucchiari

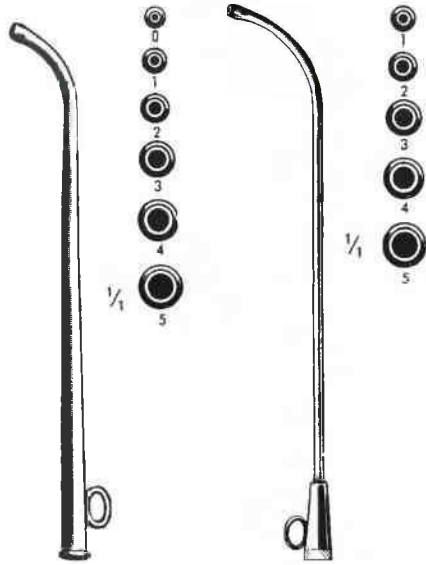

POLITZER  
H144-15018  
18 cm



POLITZER  
H144-15116  
16,5 cm

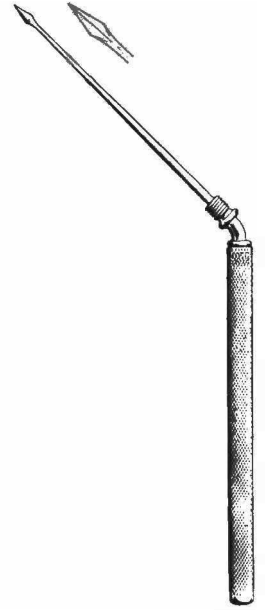

POLITZER  
H144-15316

Fig.	HARTMANN	ITARD
0	H144-13100	
1	H144-13101	H144-13301
2	H144-13102	H144-13302
3	H144-13103	H144-13303
4	H144-13104	H144-13304
5	H144-13105	H144-13305



POLITZER  
H144-16015  
15 cm



SEXTON  
H144-16218  
18 cm



SEXTON  
H144-16417  
17 cm



SEXTON  
H144-16517  
17 cm



GROSS  
H144-17012  
12 cm



GROSS  
H144-17112  
12 cm



Schlingen, Hákchen, Pinzetten, Schnürer  
Loops, Hooklets, Dressing Forceps, Snares  
Anses, Crochets, Pincas, Serrenæud  
Asas, Ganchitos, Pinzas, Cierronudos  
Anse, Uncinetti, Pinze, Serranodi

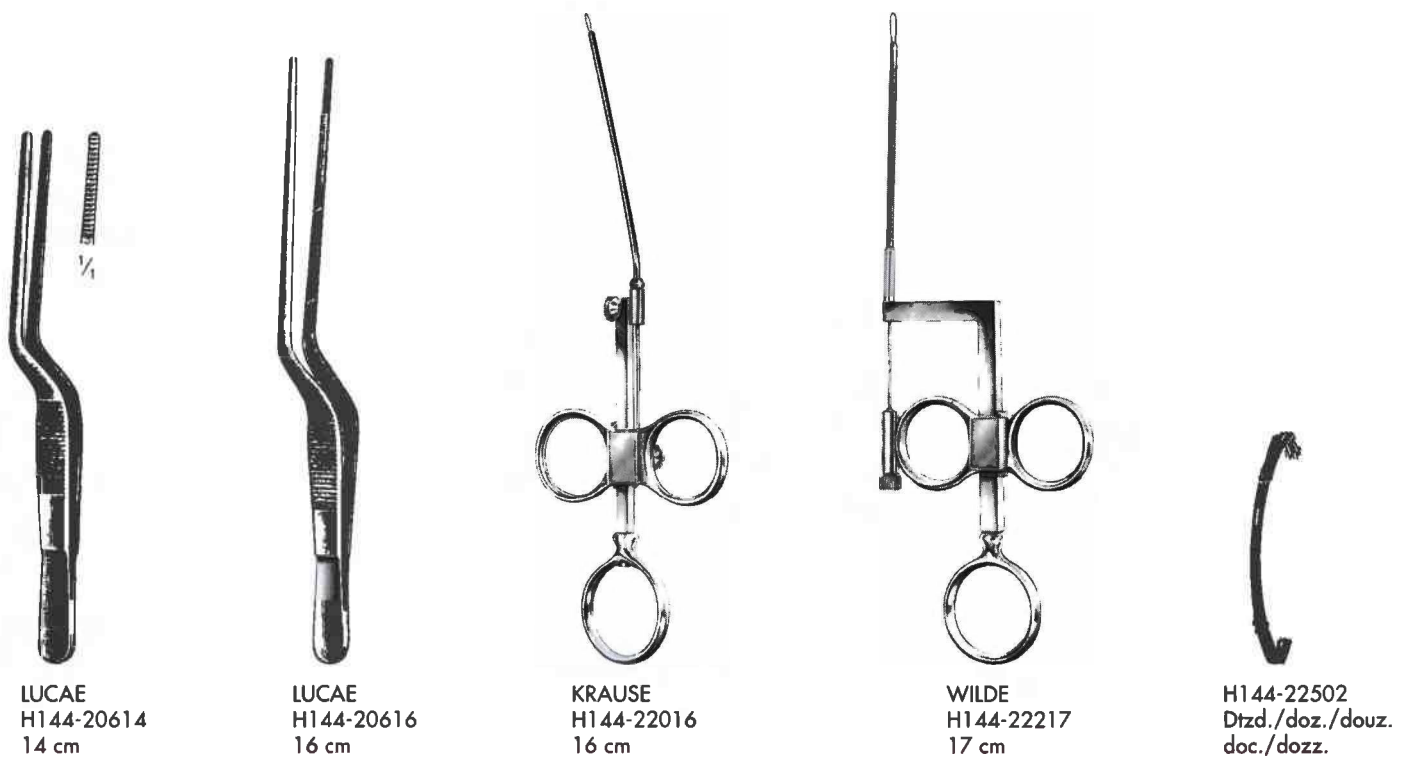
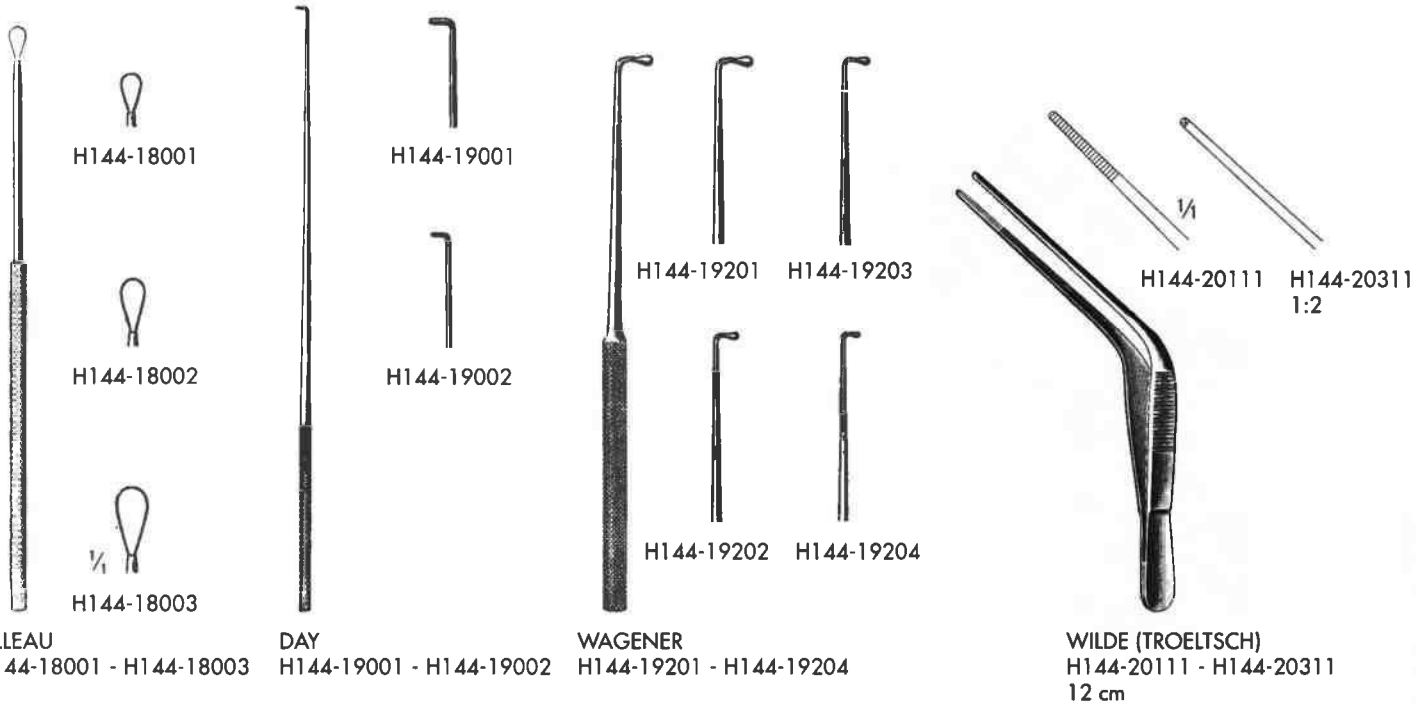

Ohrzängchen  
Ear Forceps  
Pincés auriculaires  
Pinzas auriculares  
Pinze auricolari

144

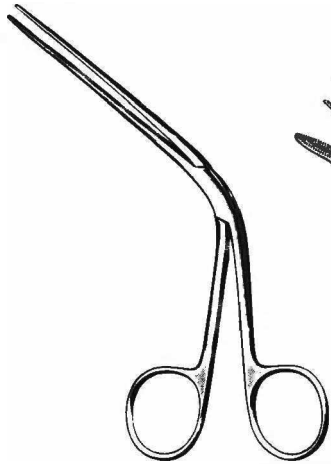

TILLEY  
H144-24314  
14 cm



LITTAUER  
H144-24512  
12 cm

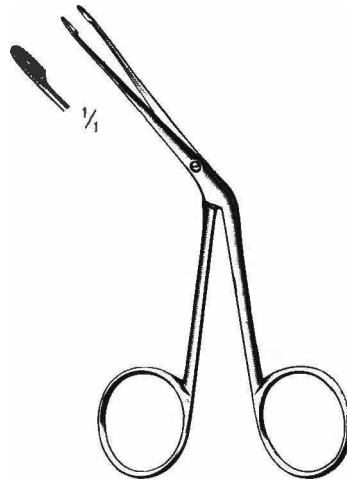

HARTMANN  
H144-24112  
12 cm

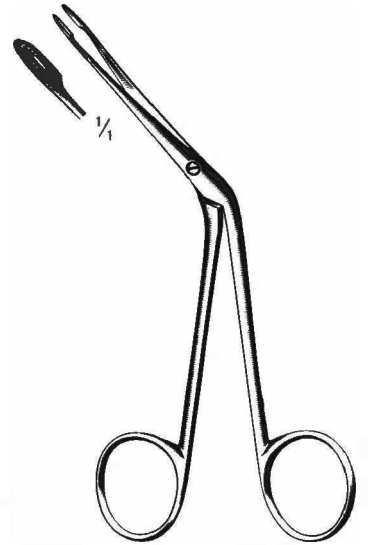

HARTMANN  
H144-24114  
14 cm



QUIRE  
H144-25110  
10 cm

Fremdkörperheber  
Foreign Body Levers  
Leviers pour corps étrangers  
Elevadores para cuerpos extranjerios  
Leve per corpi estranei

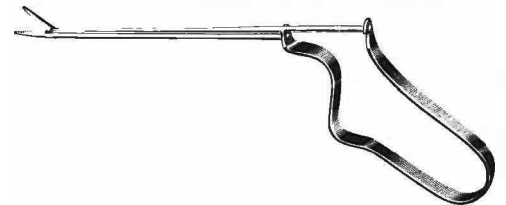

BUCK  
H144-25311  
11 cm

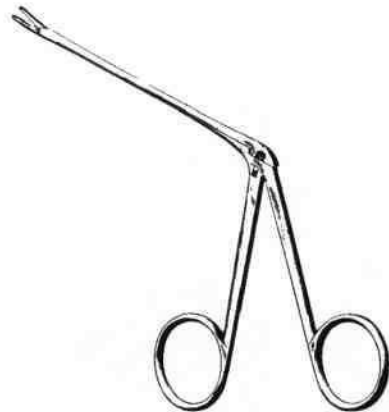

H144-25508 - H144-27508



HARTMANN-WULLSTEIN  
H144-25508  
8,5 cm



HARTMANN-WULLSTEIN  
H144-25708  
8,5 cm



cm	HARTMANN
8,5	H144-26108
14,0	H144-26114
16,0	H144-26116



cm	HARTMANN
8,5	H144-26308
14,0	H144-26314



HARTMANN  
H144-26508  
8,5 cm



Ø mm	HARTMANN
2,0	H144-26720
2,5	H144-26725
3,0	H144-26730

8,5 cm

○ 3 mm



HARTMANN  
H144-26930  
8,5 cm



STRUEMPEL  
H144-27108  
8,5 cm



HARTMANN  
H144-27308  
8,5 cm

○ 2 mm



HARTMANN-HOFFMANN  
H144-27508  
8,5 cm

Mikro-Ohrscherchen  
Micro Ear Scissors  
Ciseaux auriculaires micro  
Tijeras auriculares micro  
Forbici auricolari micro



H144-31040 - H144-32270



BELLUCCI  
H144-31040  
micro mini  
4 mm



BELLUCCI  
H144-31255  
micro standard  
5,5 mm



BELLUCCI  
H144-31355  
micro standard  
5,5 mm



BELLUCCI  
H144-31555  
micro standard  
5,5 mm



BELLUCCI  
H144-31755  
micro standard  
5,5 mm



SHEA  
H144-32070  
7,0 mm



SHEA  
H144-32170  
7,0 mm



SHEA  
H144-32270  
7,0 mm

Mikro-Ohrzängchen  
Micro Ear Forceps  
Pinces auriculaires micro  
Pinzas auriculares micro  
Pinze auricolari micro



H144-35040 - H144-36035



H144-35040  
4,0 mm



H144-35070  
7,0 mm



H144-35240  
4,0 mm



H144-35360  
6,0 mm



H144-35560  
6,0 mm



H144-35740  
4,0 mm



H144-35940  
4,0 mm



H144-36035  
3,5 mm

Mikro-Ohrzängchen  
Micro Ear Forceps  
Pincès auriculaires micro  
Pinzas auriculares micro  
Pinze auricolari micro

144



H144-36245 - H144-38330



H144-36245  
4,5 mm



H144-36345  
4,5 mm



H144-36545  
4,5 mm



H144-36750  
5,0 mm



H144-36950  
5,0 mm



GREVEN  
H144-37050  
5,0 mm



McGEE  
H144-37140  
0,8 x 4,0 mm



COS  
H144-37330  
1,8 x 0,8 x 3,0 mm



JURES  
H144-37560  
6,0 mm



JURES  
H144-37760  
6,0 mm



HAUGH  
H144-38130  
45° 3,0 mm



HAUGH  
H144-38330  
45° 3,0 mm

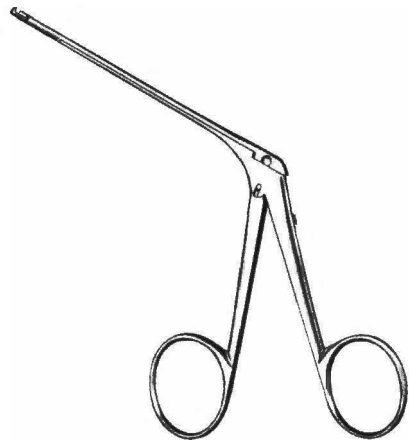

DIETER  
H144-38501 - H144-38702

Hammerkopf-Zwickzängchen  
Malleus Nippers  
Pincès pour la tête du marteau  
Pinzas para la cabeza del martillo  
Pinze per la testa del martello

micro



H144-38501

aufwärts  
upward  
en haut  
arriba  
in alto

mini



H144-38701



H144-38502

abwärts  
downward  
en bas  
abajo  
in basso



H144-38702

Modelle mit Ringgriff  
Ring Handle Patterns  
Modèles manches à anneaux  
Modelos mangos con anillos  
Modelli manici con anelli

Modelle mit Bleistiftgriff  
Pencil Handle Patterns  
Modèles manches crayon  
Modelos mango en forma de lapiz  
Modelli manico forma matita



H144-41000 - H144-41900  
micro  
RG



H144-42000 - H144-42900  
micro-mini  
RG

H144-41000  H144-43000

H144-41200  H144-43200

H144-41300  H144-43300

H144-41500  H144-43500

H144-41700  H144-43700

H144-41900  H144-43900

 H144-43908

H144-42000  H144-44000

H144-42200  H144-44200

H144-42300  H144-44300

H144-42500  H144-44500

H144-42700  H144-44700

H144-42900  H144-44900



H144-43000 - H144-43908  
micro  
BG



H144-44000 - H144-44900  
micro-mini  
BG



Mikro-Ohrzängchen  
Micro Ear Forceps  
Pincès auriculaires micro  
Pinzas auriculares micro  
Pinze auricolari micro

144



Modelle mit Ringgriff  
Handle Patterns  
Les manches à anneaux  
Los mangos con anillos  
I manici con anelli

H144-51000 - H144-54900  
micro  
RG



Modelle mit Bleistiftgriff  
Pencil Handle Patterns  
Les manches crayon  
Los mangos en forma de lapiz  
I manici in forma matita

H144-61000 - H144-64900  
micro  
BG

H144-51000		H144-61000
H144-51100		H144-61100
H144-51300		H144-61300
H144-51400		H144-61400
H144-51500		H144-61500
H144-51600		H144-61600
H144-51700		H144-61700
H144-51900		H144-61900
H144-52000		H144-62000
H144-52100		

Ø 1mm    Ø 1,5 mm    Ø 2 mm    Ø 2,5 mm

H144-52200	H144-52800	H144-53400	H144-54000
H144-52300	H144-52900	H144-53500	H144-54100
H144-52500	H144-53100	H144-53700	H144-54300
H144-52700	H144-53300	H144-53900	H144-54500

H144-54600		H144-64600
H144-54700		H144-64700
H144-54800		H144-64800
H144-54900		H144-64900

Ø 1mm    Ø 1,5 mm    Ø 2 mm    Ø 2,5 mm

H144-62200	H144-62800	H144-63400	H144-64000
H144-62300	H144-62900	H144-63500	H144-64100
H144-62500	H144-63100	H144-63700	H144-64300
H144-62700	H144-63300	H144-63900	H144-64500

Modelle mit Ringgriff  
Ring Handle Patterns  
Modèles manches à anneaux  
Modelos mangos con anillos  
Modelli manici con anelli



H144-55000 - H144-58900  
micro-mini  
RG

Modelle mit Bleistiftgriff  
Pencil Handle Patterns  
Modèles manches crayon  
Modelos mango en forma de lapiz  
Modelli manico forma matita



H144-65000 - H144-68900  
micro-mini  
BG

H144-55000		H144-65000
H144-55100		H144-65100
H144-55300		H144-65300
H144-55400		H144-65400
H144-55500		H144-65500
H144-55600		
H144-55700		H144-65700
H144-55900		H144-65900
H144-56000		H144-66000
H144-56100		
H144-56200		H144-66200
H144-56300		H144-66300
H144-56500		H144-66500
H144-56700		H144-66700
H144-58600		H144-68600
H144-58700		H144-68700
H144-58800		H144-68800
H144-58900		H144-68900

Otologie  
Otology  
Otologie  
Otología  
Otologia



SCHUKNECHT  
H144-70101



SCHUKNECHT  
H144-70102



SCHUKNECHT  
H144-70315  
15,5 cm



WULLSTEIN  
H144-70415  
15,5 cm



TABB  
H144-70515  
15,5 cm



PLESTER  
H144-70635  
15,5 cm/3,5 mm Ø

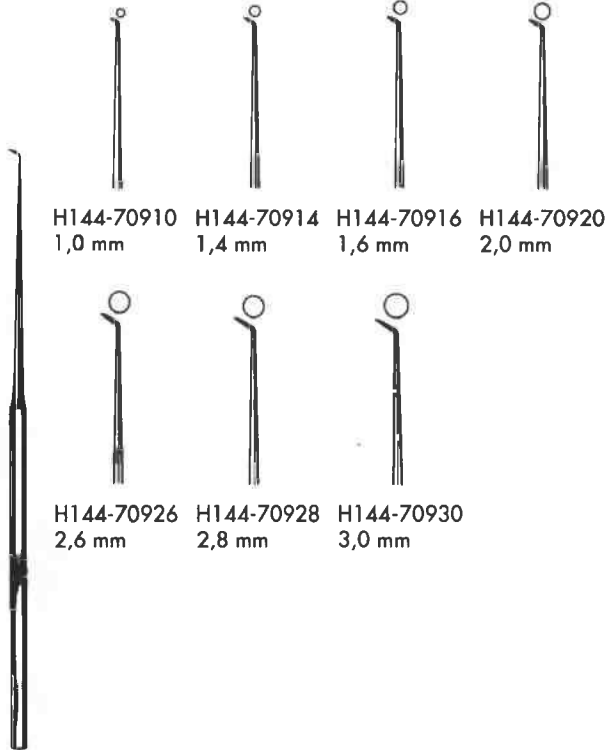

H144-70910 1,0 mm  
H144-70914 1,4 mm  
H144-70916 1,6 mm  
H144-70920 2,0 mm

H144-70926 2,6 mm  
H144-70928 2,8 mm  
H144-70930 3,0 mm

ROSEN  
H144-70910 - H144-70930

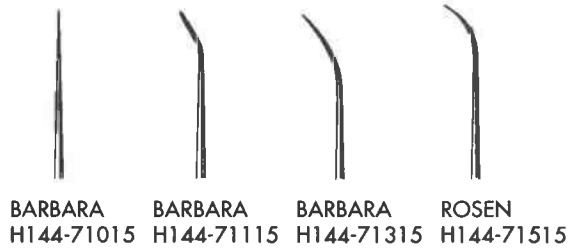

BARBARA H144-71015  
BARBARA H144-71115  
BARBARA H144-71315  
ROSEN H144-71515

	25°	45°	90°	
mm	BARBARA	BARBARA	BARBARA	BARBARA
0,3	H144-72003	H144-72203	H144-72403	H144-72505 = 0,5
0,6	H144-72006	H144-72206	H144-72406	H144-72510 = 1,0
1,0	H144-72010	H144-72210	H144-72410	
1,2		H144-72212	H144-72412	
1,5		H144-72215	H144-72415	
2,0		H144-72220	H144-72420	
2,5		H144-72225	H144-72425	

H144-71015 - H144-72510



mm	90°	90°	mm	McGEE	McGEE	BARBARA
0,3	H144-73003	H144-73203	0,5	H144-73305	H144-73505	H144-73615
0,6	H144-73006	H144-73206	1,0	H144-73310	H144-73510	15,5 cm
1,0	H144-73010	H144-73210				

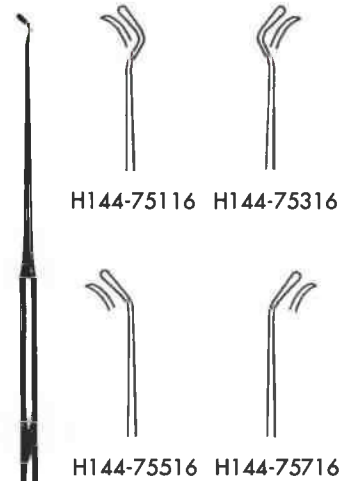

H144-75116 H144-75316  
H144-75516 H144-75716

ROSEN	mm	25°	25°	45°	45°
H144-73715	0,3	H144-74103	H144-74303	H144-74503	H144-74703
15,5 cm	0,6	H144-74106	H144-74306	H144-74506	H144-74706
	1,0	H144-74110	H144-74310	H144-74510	H144-74710

FISCH  
H144-75116 - H144-75716

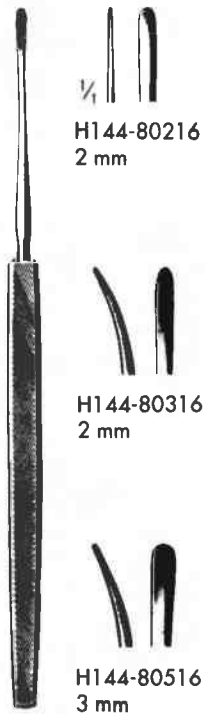

H144-80216  
2 mm

H144-80316  
2 mm

H144-80516  
3 mm

LEMPERT  
H144-80216 - H144-80516



mm	
1,0/1,2	H144-76001
1,5/1,8	H144-76002

mm	
1,0/1,2	H144-76201
1,5/1,8	H144-76202

HOUSE  
H144-76001 - H144-76202

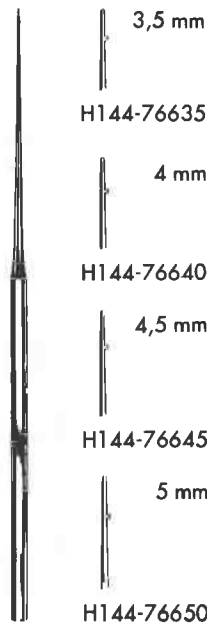

3,5 mm  
H144-76635  
4 mm  
H144-76640  
4,5 mm  
H144-76645  
5 mm  
H144-76650

HOUSE  
H144-76635 - H144-76650



LEMPERT  
H144-80720  
20,5 cm

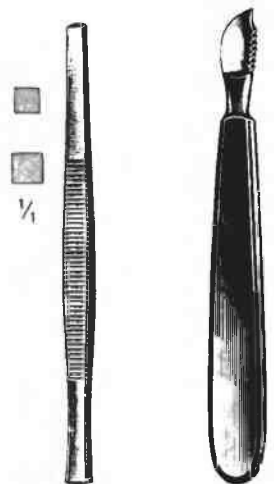

mm PASSOW  
2x2 H144-81002  
3x3 H144-81003

MUCK  
H144-81213  
13 cm

Rhinologie  
Rhinology  
Rhinologie  
Rinología  
Rinologia

Nasenspekula  
Nasal Specula  
Spéculums nasaux  
Espéculos nasales  
Specoli nasali

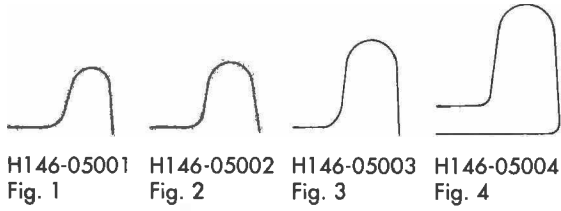

H146-05001 Fig. 1    H146-05002 Fig. 2    H146-05003 Fig. 3    H146-05004 Fig. 4

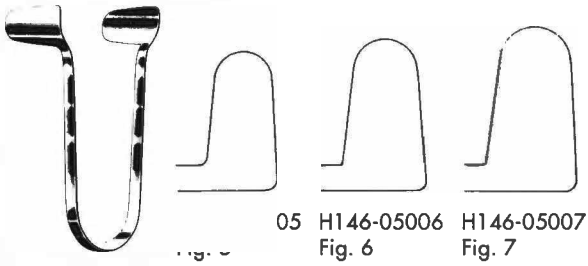

THUDICHUM  
H146-05001 - H146-05007

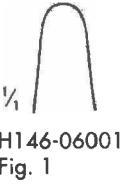

H146-06001  
Fig. 1



H146-06002  
Fig. 2



H146-06003  
Fig. 3



VOLTOLINI  
H146-06001 - H146-06003

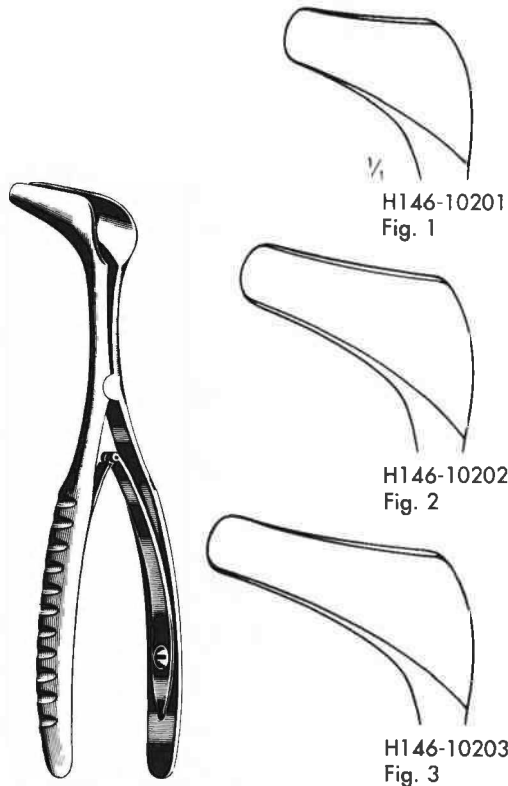

HARTMANN-HALLE  
H146-10201 - H146-10203  
15 cm

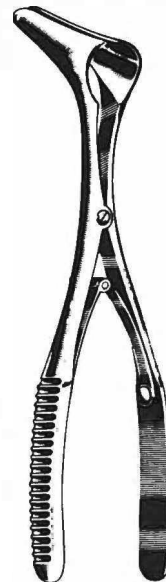

Mod. Wien · Vienna  
Vienne · Viena

Baby · Bébé	H146-11201
Kind · child · enf. · niño · bamb.	H146-11202
Erw. · Adult	H146-11203

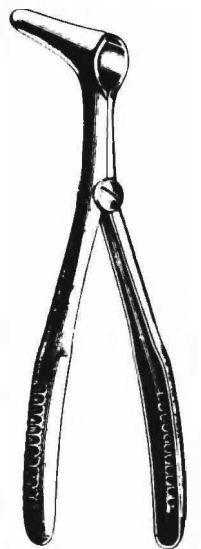

Mod. Wien · Vienna  
Vienne · Viena  
H146-11303  
leichtes Modell  
lightweight  
mod. léger  
mod. ligero  
mod. leggero



Nasenspekula  
Nasal Specula  
Spéculums nasaux  
Espéculos nasales  
Specoli nasali



TIECK-HALLE  
H146-11613  
13,5 cm



KILLIAN  
H146-12035 - H146-12090  
13 cm

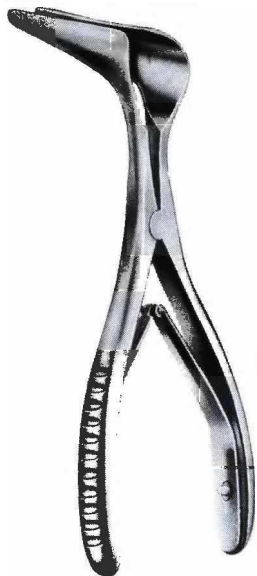
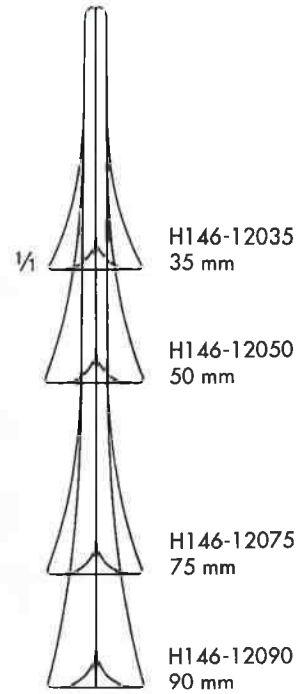

COTTLE  
H146-12435 - H146-12490  
14 cm

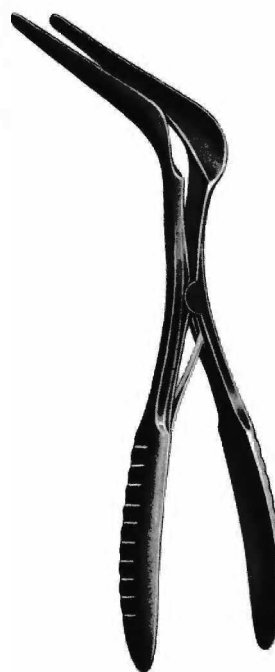

COTTLE  
H146-12635 - H146-12690  
schwarz · black · noirs  
negros · neri  
14 cm

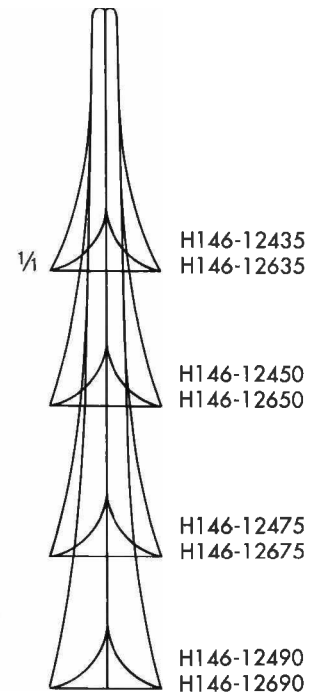

Rhinologie  
Rhinology  
Rhinologie  
Rinología  
Rinologia

146

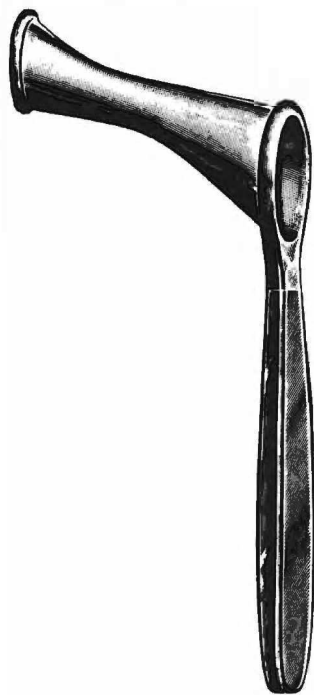

YANKAUER  
H146-13119  
19 cm

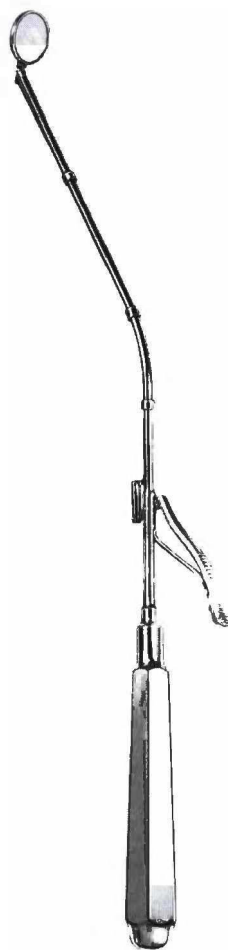

MICHEL  
H146-13912 · H146-13918  
25 cm



H146-13912  
12 mm



H146-13914  
14 mm

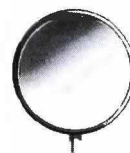

H146-13916  
16 mm

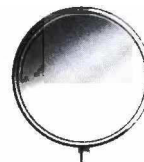

H146-13918  
18 mm

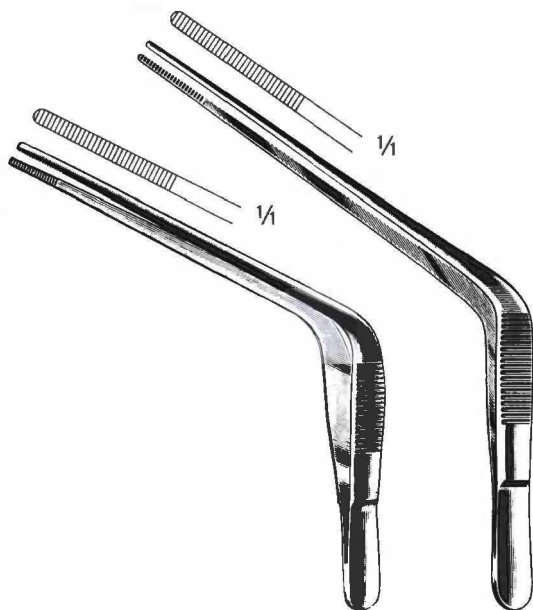

TROELTSCH  
H146-15115  
15 cm

TROELTSCH  
H146-15118  
18 cm



JANSSEN  
H146-15420  
20 cm

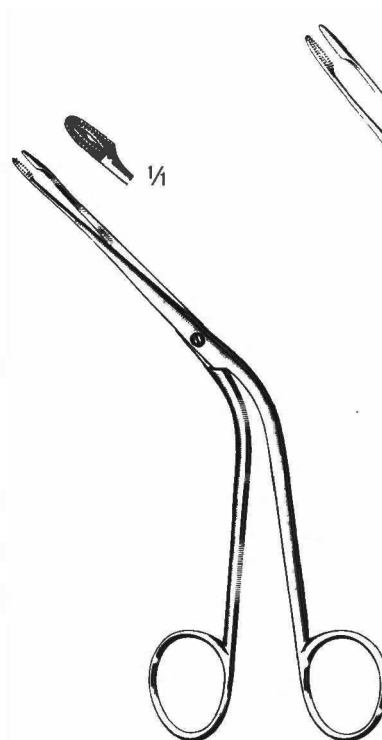

HARTMANN  
H146-16116  
16 cm

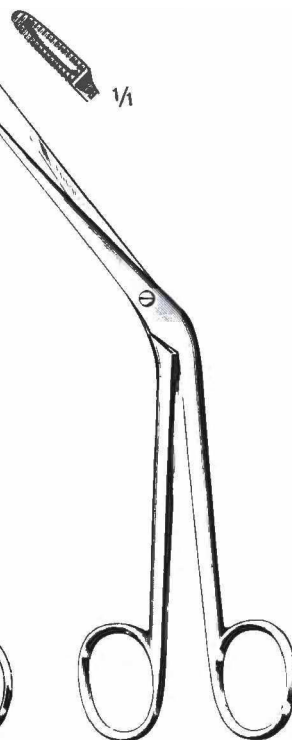

HARTMANN  
H146-16120  
20 cm

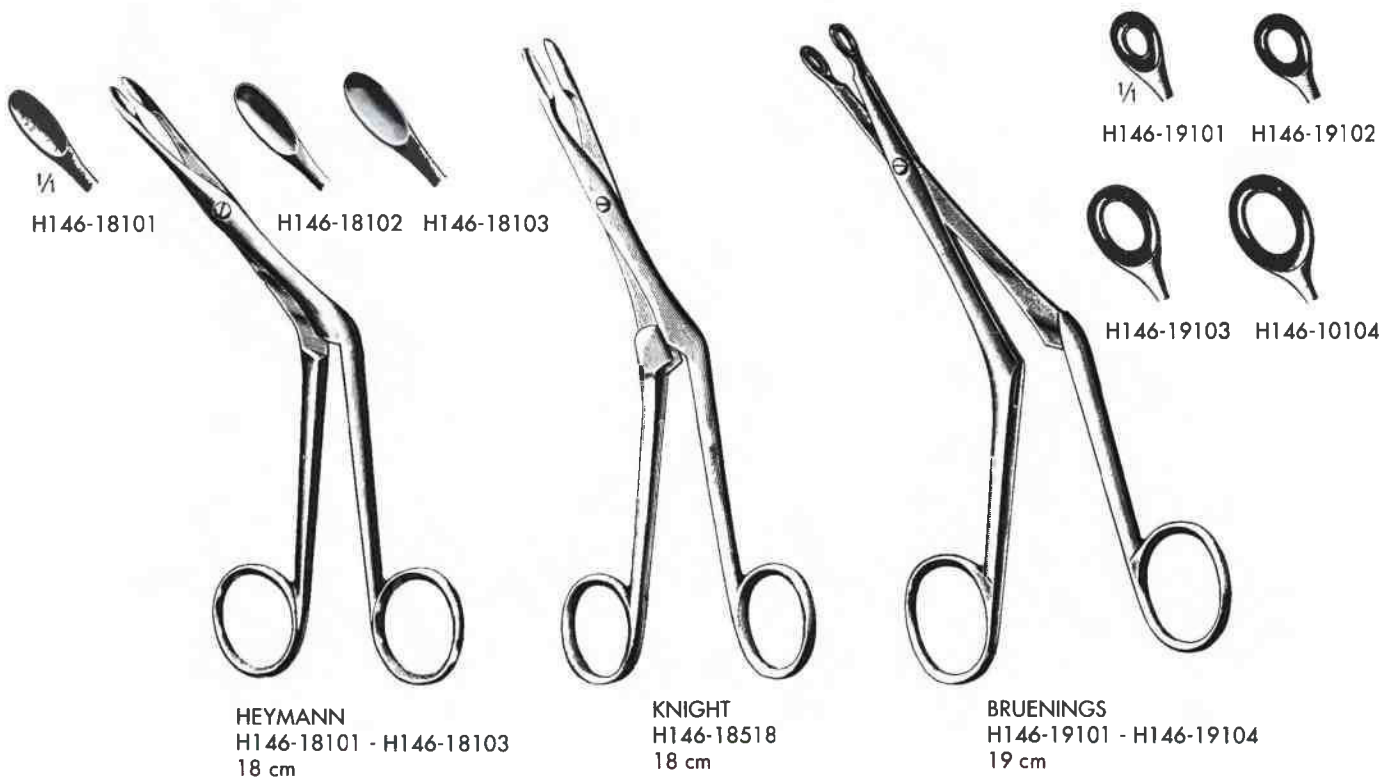
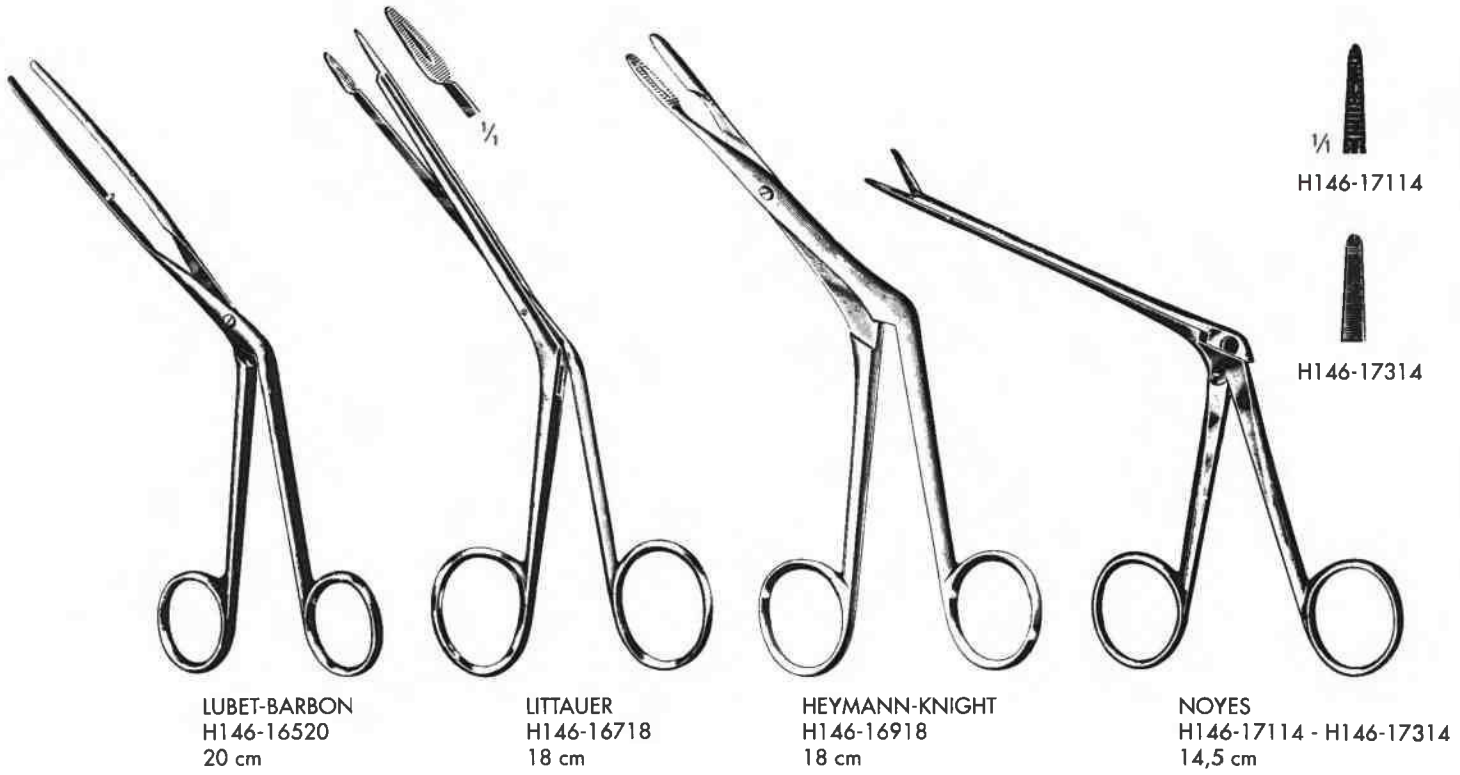

Rhinologie  
Rhinology  
Rhinologie  
Rinología  
Rinologia

Scharfe Nasenzangen  
Nasal Cutting Forceps  
Pinces coupantes nasales  
Pinzas cortantes nasales  
Pinze taglienti nasali



LUC  
H146-19501 - H146-19502  
19 cm

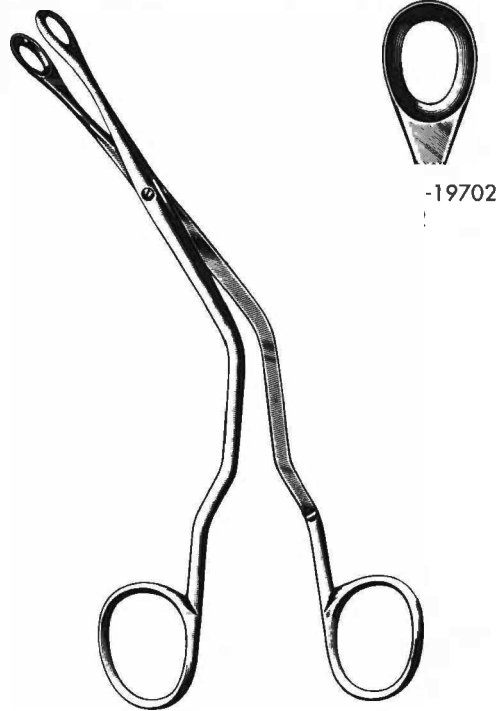

LUC  
H146-19701 - H146-19702  
19 cm

ohne Hals  
without neck  
sans cou  
sin cuello  
senza collo



H146-22101  
Fig. 1

H146-22102  
Fig. 2

H146-22103  
Fig. 3

H146-22104  
Fig. 4

H146-22105  
Fig. 5

mit Hals  
with neck  
avec cou  
con cuello  
con collo



H146-22301  
Fig. 1

H146-22302  
Fig. 2

H146-22303  
Fig. 3

H146-22304  
Fig. 4

H146-22305  
Fig. 5

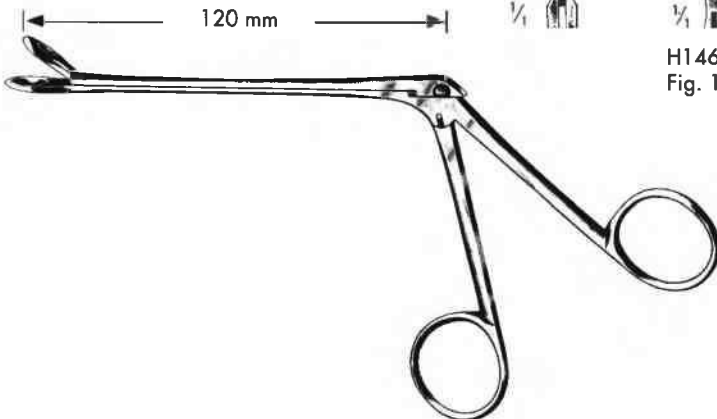

WEIL-BLAKESLEY  
H146-22101 - H146-22305  
19 cm

Scharfe Nasenzangen  
Nasal Cutting Forceps  
Pincas coupantes nasales  
Pinzas cortantes nasales  
Pinze taglianti nasali



H146-23101 - H146-23703  
19 cm

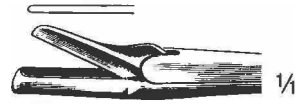

STRUYCKEN  
H146-23101  
Fig. 1

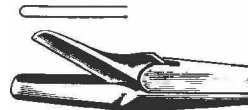



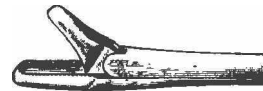

STRUYCKEN  
H146-23102  
Fig. 2

- H146-23701  
5 mm
- H146-23702  
7 mm
- H146-23703  
9 mm



MYLES

-  H146-23505
-  H146-23507
-  H146-23509
-  H146-23511
-  1/4

HARTMANN

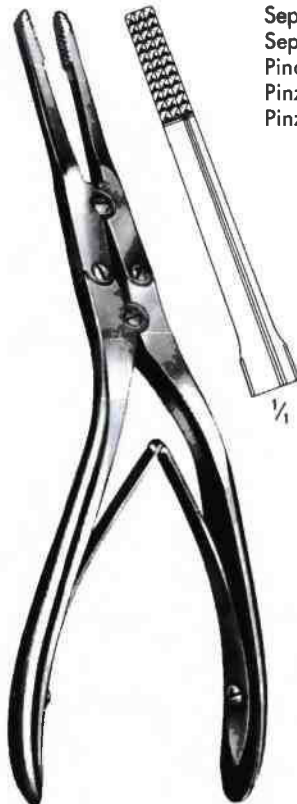

RUBIN  
H146-25121  
21 cm

Septum-Quetschzange  
Septum Crushing Forceps  
Pince à écraser la cloison  
Pinza para magullar tabique  
Pinza per ammaccare il setto



Rhinologie  
Rhinology  
Rhinologie  
Rinología  
Rinologia

146



mm x mm	KERRISON
3 x 3	H146-30303
4 x 4	H146-30304
5 x 5	H146-30305
6 x 6	H146-30306
	17 cm

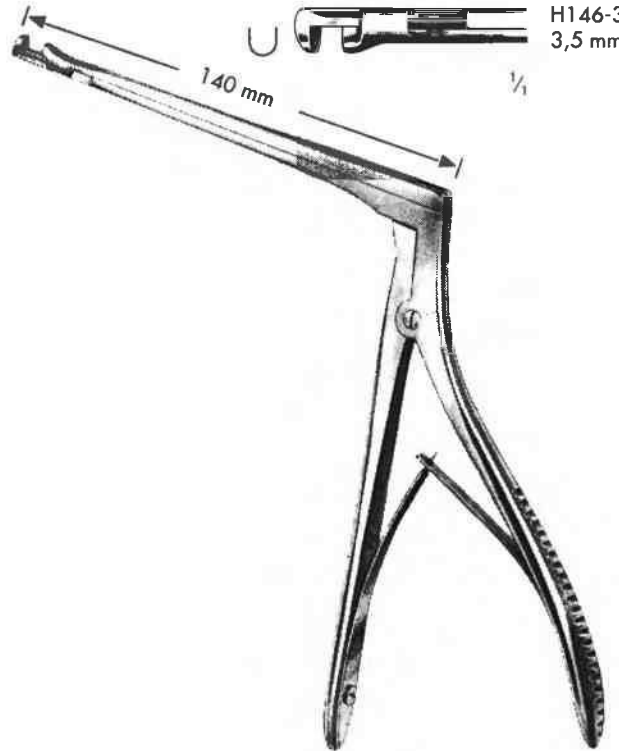

HAJEK-KOFLER  
H146-30501 - H146-30502

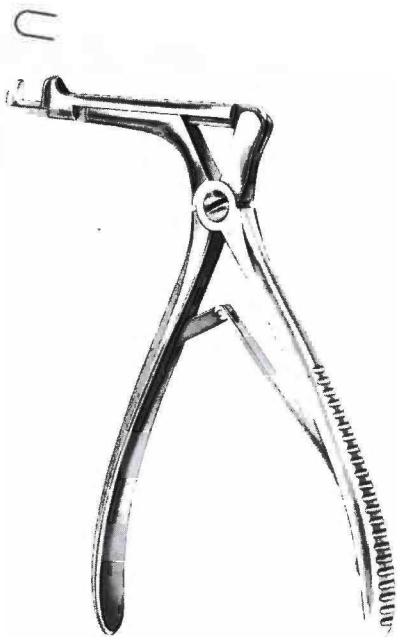

mm	CITELLI
1,0	H146-31110
2,5	H146-31125
4,0	H146-31140



BEYER  
H146-31520  
2,0 mm

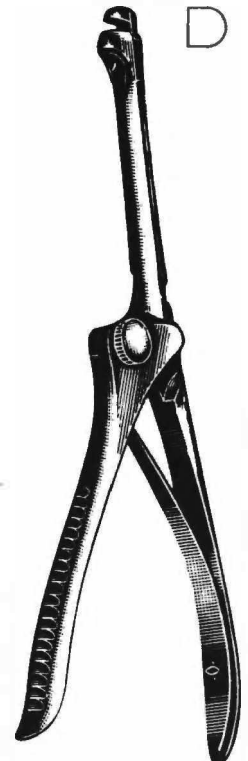

HAJEK-CLAUS  
H146-32020  
20 cm

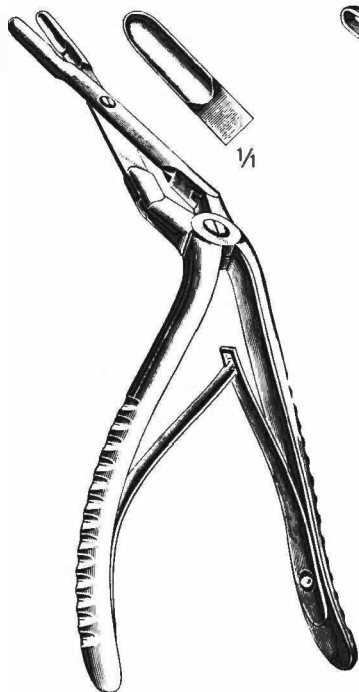

MIDDLETON-JANSEN  
H146-32319  
19 cm

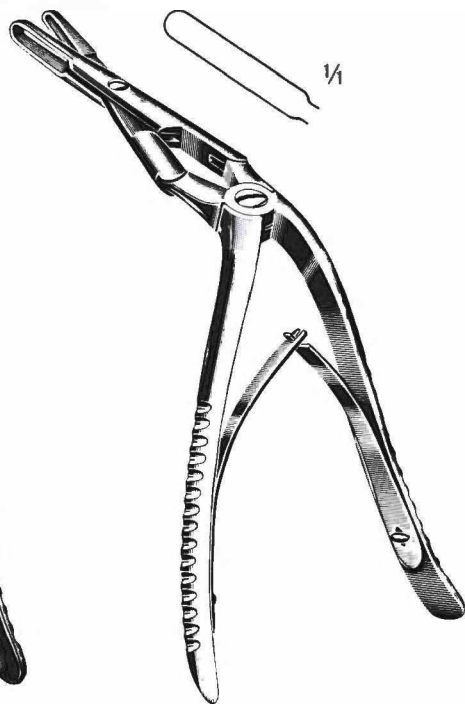

MIDDLETON-JANSEN  
H146-32519  
19 cm



Ø mm	LICHTWITZ
1,5	H146-34015
1,8	H146-34018
2,0	H146-34020

Luer-Lock  
10 cm



KILLIAN  
H146-34103  
14 cm/3 mm Ø

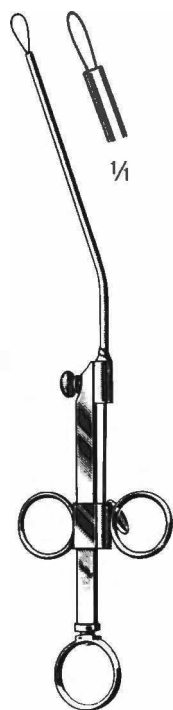

KRAUSE  
H146-35126  
26 cm

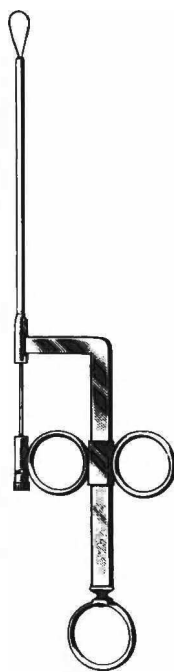

WILDE  
H146-35224  
24 cm



H146-35503  
0,3 mm

Rhinologie  
Rhinology  
Rhinologie  
Rinologia  
Rinologia

146

Nasenmesser  
Nasal Knives  
Bistouris nasaux  
Bisturies nasales  
Coltelli nasali

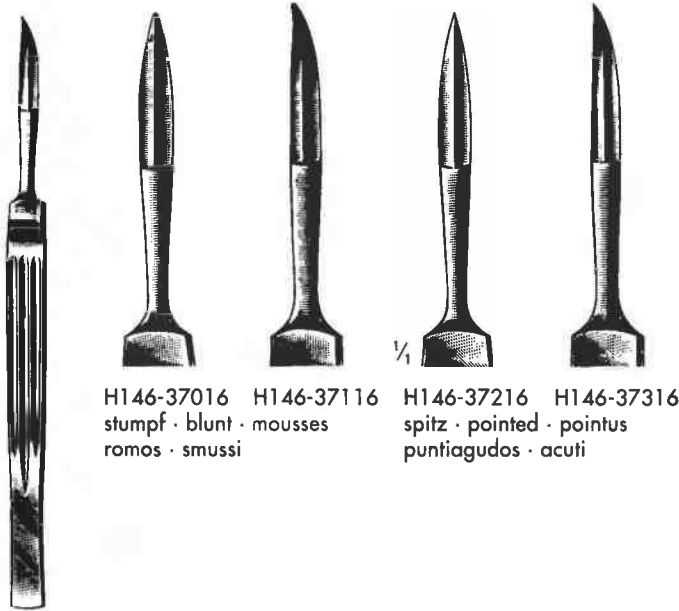

H146-37016 H146-37116 H146-37216 H146-37316  
stumpf · blunt · mousses spitz · pointed · pointus  
romos · smussi puntiagudos · acuti

JOSEPH  
H146-37016 - H146-37316



FREER  
H146-37415  
15 cm



FREER  
H146-37519  
19 cm

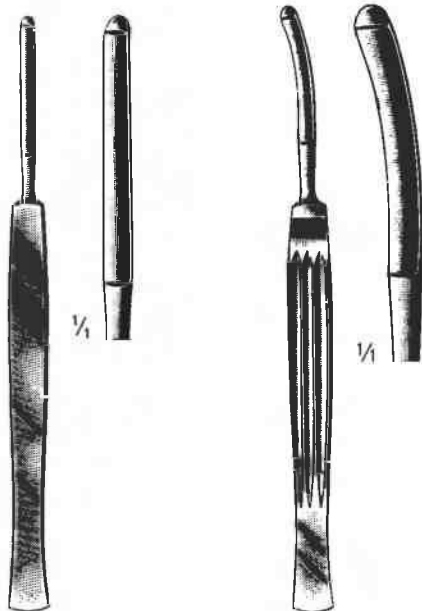

JOSEPH  
H146-37616  
16 cm

CONVERSE  
H146-37916  
16 cm



COTTLE  
H146-38015  
15 cm



H146-38215



COTTLE  
H146-38415



H146-38515

Septum-Messer  
Septum Knives  
Couteaux pour la cloison  
Cuchillos para tabique  
Coltelli per setto

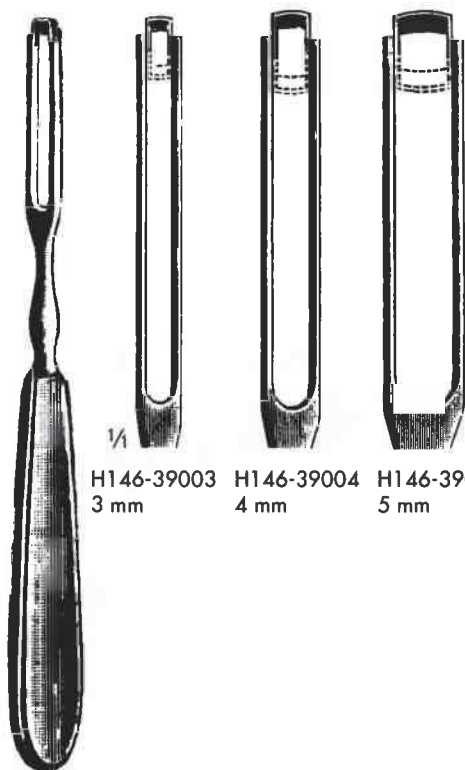

H146-39003 3 mm  
H146-39004 4 mm  
H146-39005 5 mm

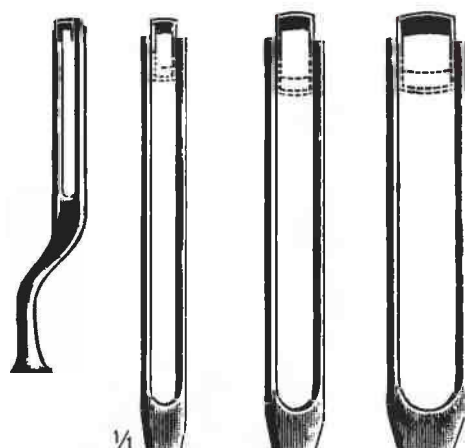

H146-39203 3 mm  
H146-39204 4 mm  
H146-39205 5 mm



BRUENINGS  
H146-39816  
16,5 cm

BALLENGER  
H146-39003 - H146-39205  
20 cm

Septum-Elevatorien  
Septum Elevators  
Élévateurs pour la cloison nasale  
Elevadores para tabique  
Elevatori per setto

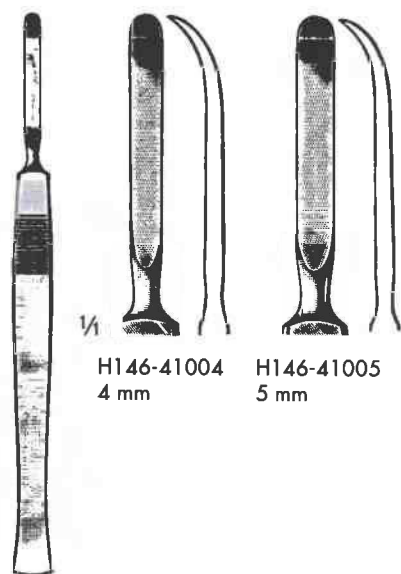

H146-41004 4 mm  
H146-41005 5 mm



ROGER  
H146-41319  
19 cm



FREER  
H146-41518  
18 cm

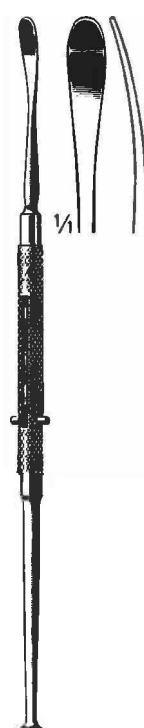

FREER  
H146-41719  
19 cm



FREER  
H146-41919  
19 cm

McKENTY  
H146-41004 - H146-41005  
15 cm

Rhinologie  
Rhinology  
Rhinologie  
Rinología  
Rinologia

146



COTTLE  
H146-42123  
23 cm



COTTLE  
H146-42322  
22 cm

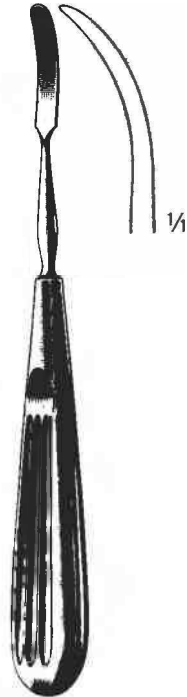

JOSEPH  
H146-42516  
16 cm



COTTLE  
H146-42519  
19 cm



KILLIAN  
H146-42622  
22 cm



HAJEK-BALLENGER  
H146-42821  
22 cm



BALLENGER  
H146-43022  
22 cm



FREER  
H146-45004  
4 mm



FREER  
H146-45104  
4 mm



Nasenplastik-Meißel  
Rhinoelastic Chisels  
Ciseaux-burins pour la plastique nasale  
Cinceles para la plástica nasal  
ScalPELLi per plastica nasale



H146-45404  
4 mm

H146-45407  
7 mm

H146-45409  
9 mm

H146-45412  
12 mm

COTTLE  
H146-45404 - H146-45412  
18 cm



COTTLE  
H146-45506  
18 cm/6 mm

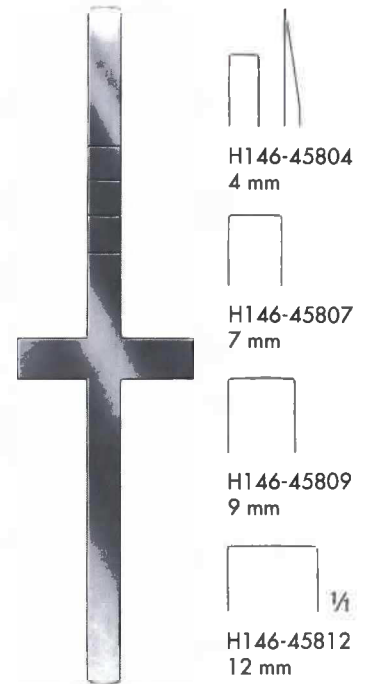

H146-45804  
4 mm

H146-45807  
7 mm

H146-45809  
9 mm

H146-45812  
12 mm

COTTLE  
H146-45804 - H146-45812

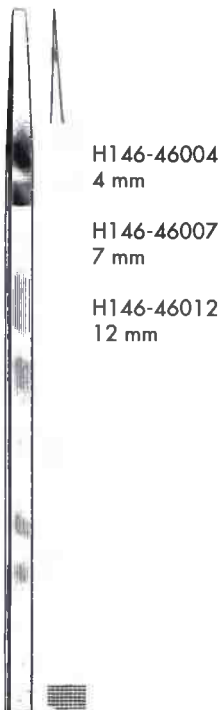

H146-46004  
4 mm

H146-46007  
7 mm

H146-46012  
12 mm

COTTLE  
H146-46004 - H146-46012  
18 cm

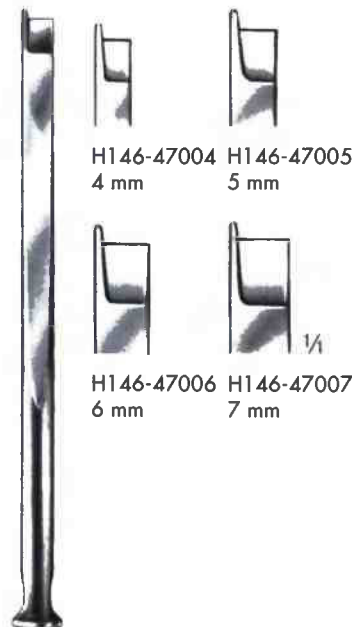

H146-47004 H146-47005  
4 mm 5 mm

H146-47006 H146-47007  
6 mm 7 mm

FOMON  
H146-47004 - H146-47007  
17 cm

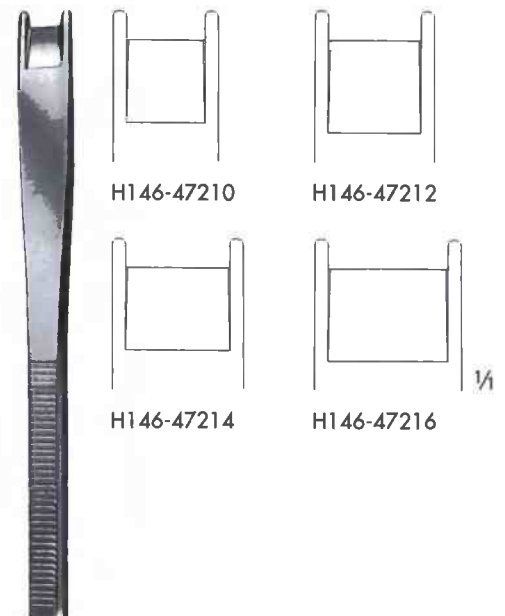

H146-47210

H146-47212

H146-47214

H146-47216

CINELLI  
H146-47210 - H146-47216

Rhinologie  
Rhinology  
Rhinologie  
Rinología  
Rinologia

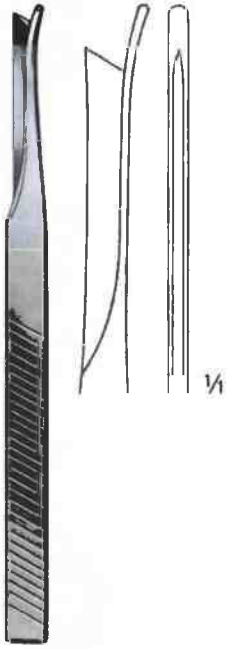

SILVER  
H146-47301  
18 cm

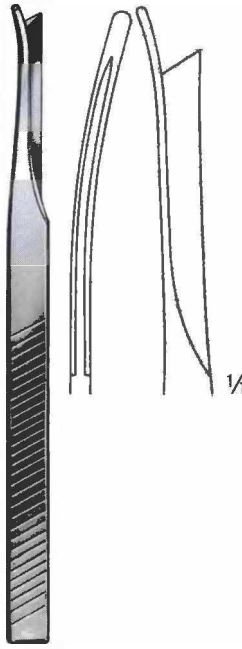

SILVER  
H146-47302  
18 cm

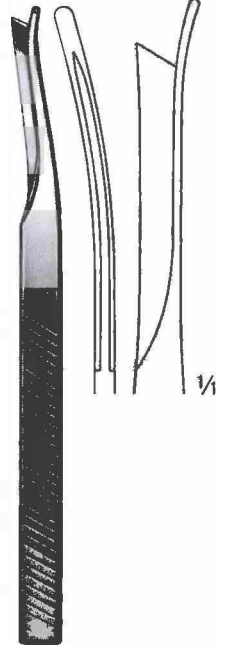

SILVER  
H146-47303  
18 cm



KILLIAN-CLAUS  
H146-48205  
17 cm/5 mm



mm	HAJEK
4	H146-48404
6	H146-48406
8	H146-48408



WEST  
H146-48616  
16 cm



WEST  
H146-48716  
16 cm



FREER  
H146-48916  
6 mm

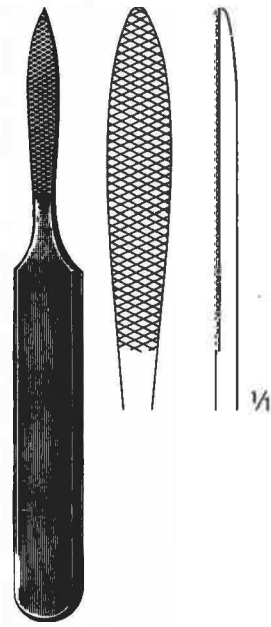

JOSEPH  
H146-50216  
16 cm

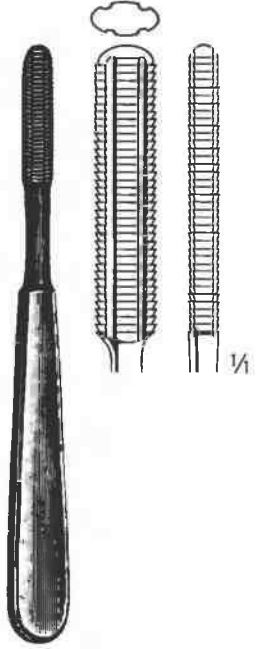

MALTZ  
H146-50418  
18 cm



$\frac{1}{4}$   
H146-50718    H146-50719

LEWIS  
H146-50718 - H146-50719  
18 cm

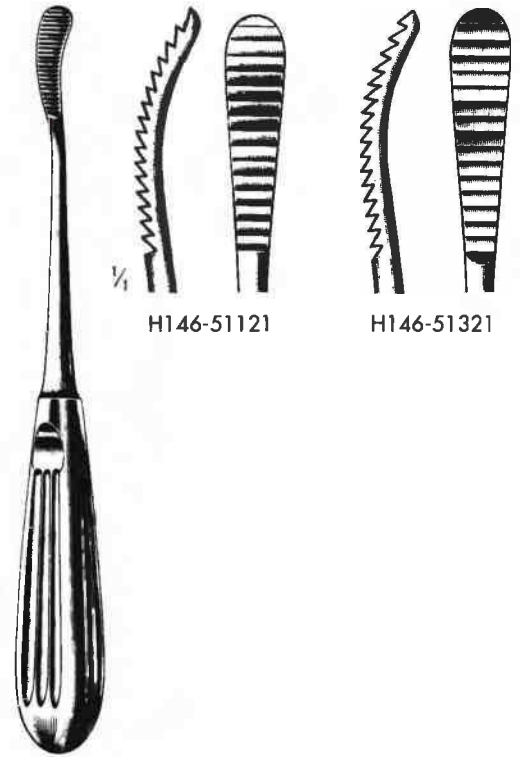

$\frac{1}{4}$     H146-51121    H146-51321

AUFRICHT  
H146-51121 - H146-51321  
21 cm

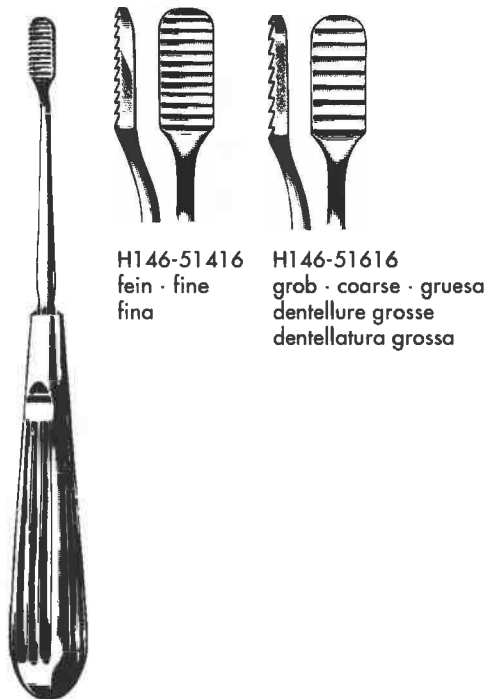

H146-51416    H146-51616  
fein · fine    grob · coarse · gruesa  
fina    dentellure grosse  
dentellatura grossa

JOSEPH (LEWIS)  
H146-51416 - H146-51616  
18 cm

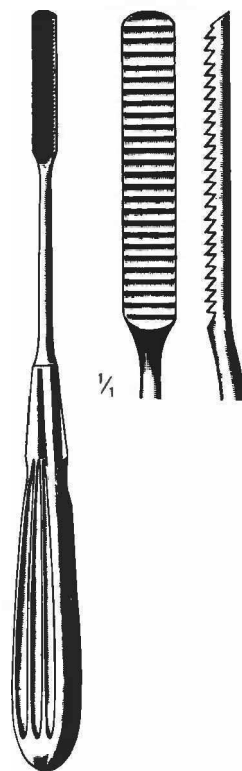

MALTZ (COTTLE)  
H146-51821  
21 cm

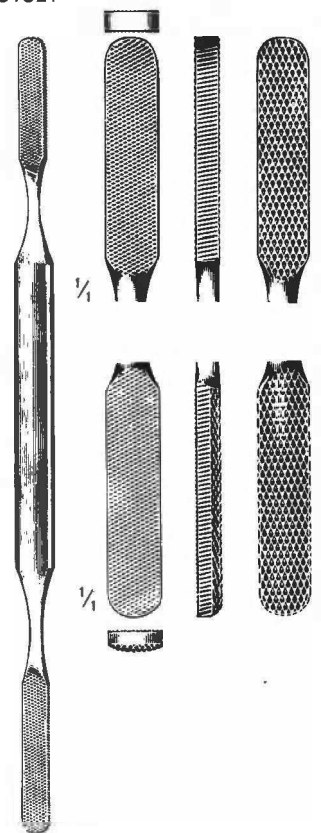

FOMON  
H146-52021  
21 cm

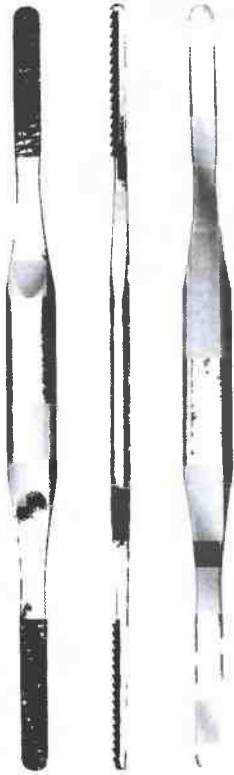

FOMON  
20 cm TC

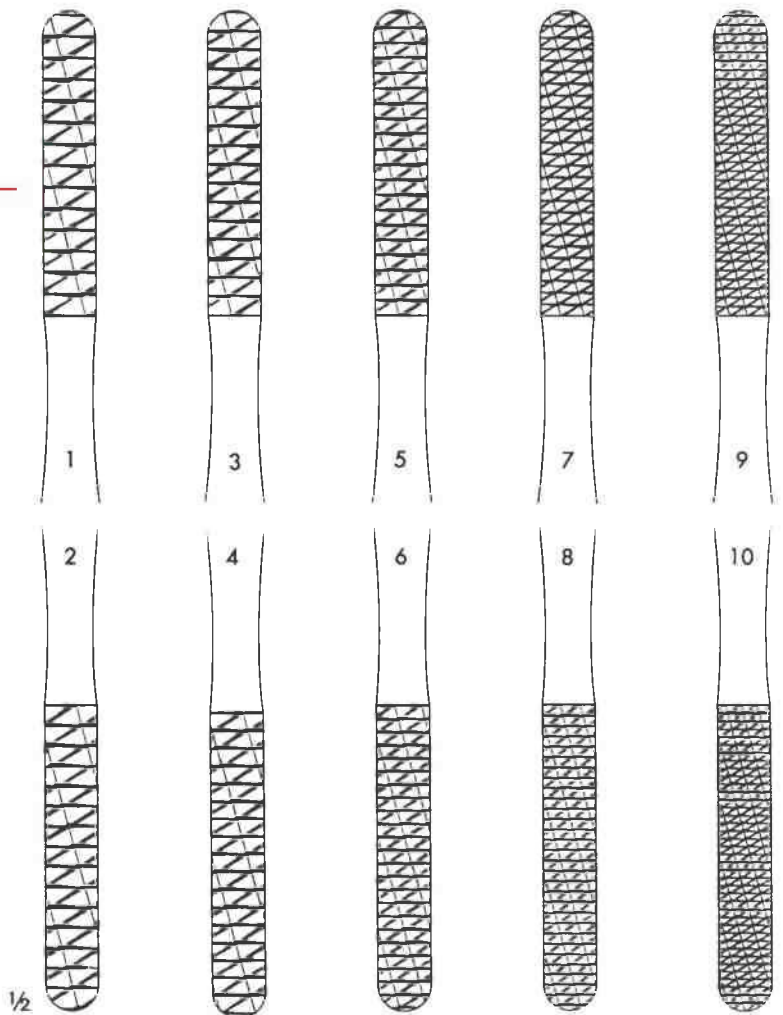

Fig. 1/2

H146-52201

Fig. 3/4

H146-52203

Fig. 5/6

H146-52205

Fig. 7/8

H146-52207

Fig. 9/10

H146-52209

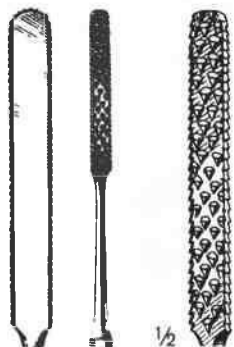

Fig. 1

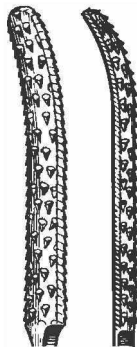

Fig. 2

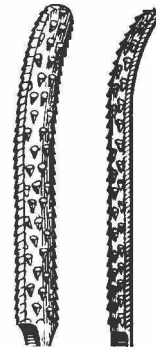

Fig. 3



GALLAHER

H146-52616

H146-52716

H146-52916



**JOSEPH**  
19 cm  
H146-53219 links · left  
à gauche  
izquierda  
a sinistra  
H146-53419 rechts · right  
à droite  
derecha  
a destra

**JOSEPH**  
H146-53501 17 cm H146-53502

**AUFRICHT**  
H146-55116  
16 cm

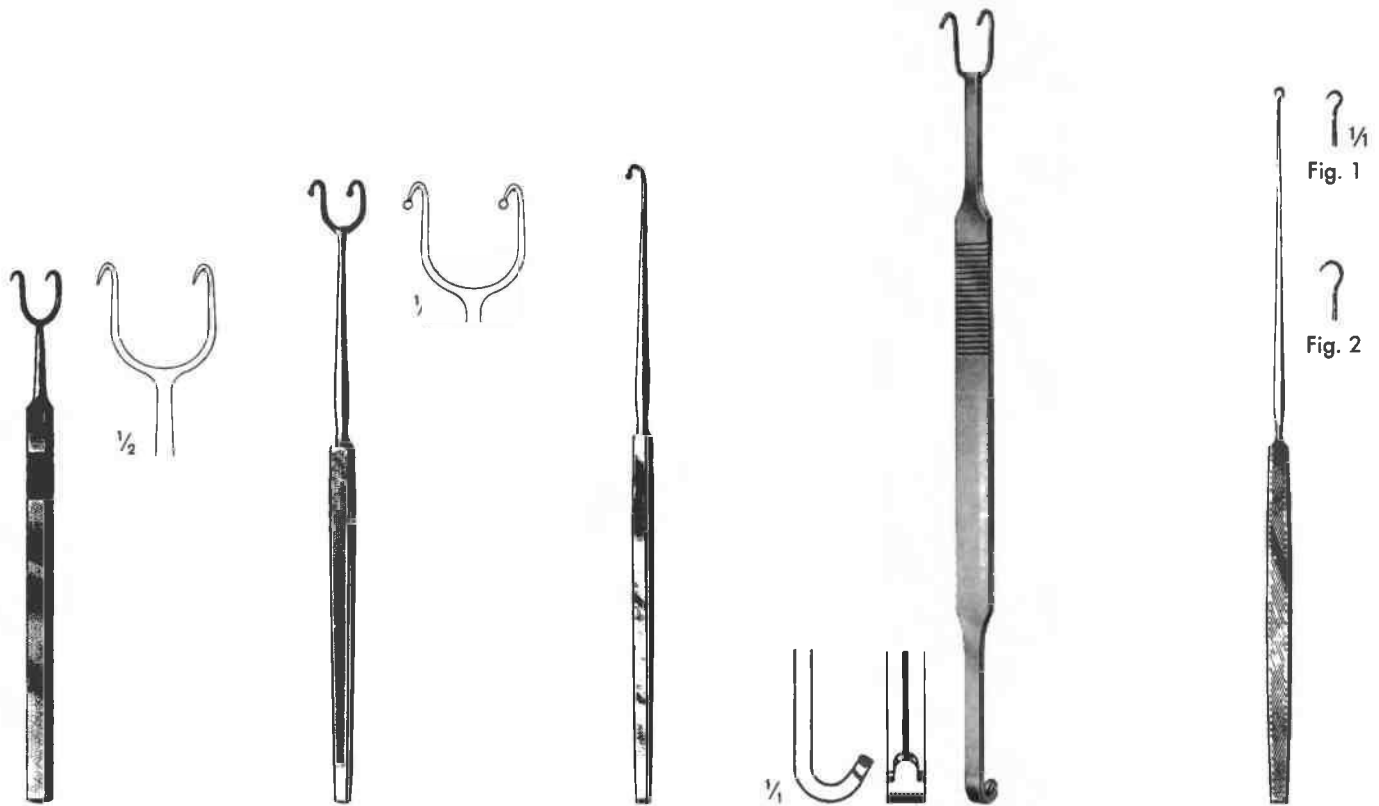

**COTTLE**  
H146-55614

**FOMON**  
H146-55616

**FOMON**  
H146-55717

**COTTLE-NEIVERT**  
H146-55920

**Fig. GILLIES**  
1 H146-56018  
2 H146-56218  
18 cm



Rhinologie  
Rhinology  
Rhinologie  
Rinología  
Rinologia

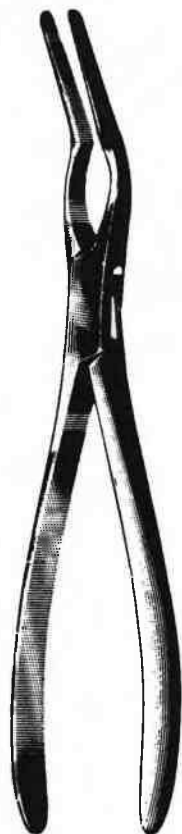

ASCH  
H146-57123  
23 cm

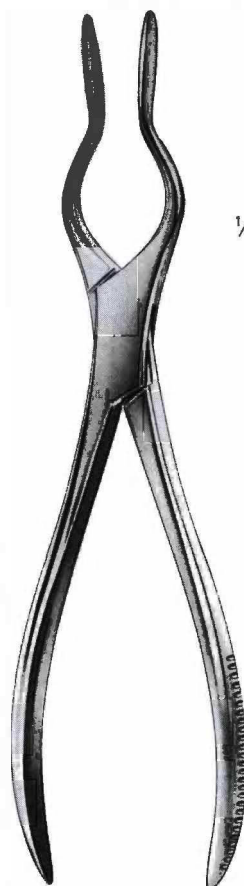

WALSHAM  
H146-57223 - H146-57523  
23 cm



7223 H146-57323 H146-57523  
links left rechts  
à gauche right  
izquierda a destra

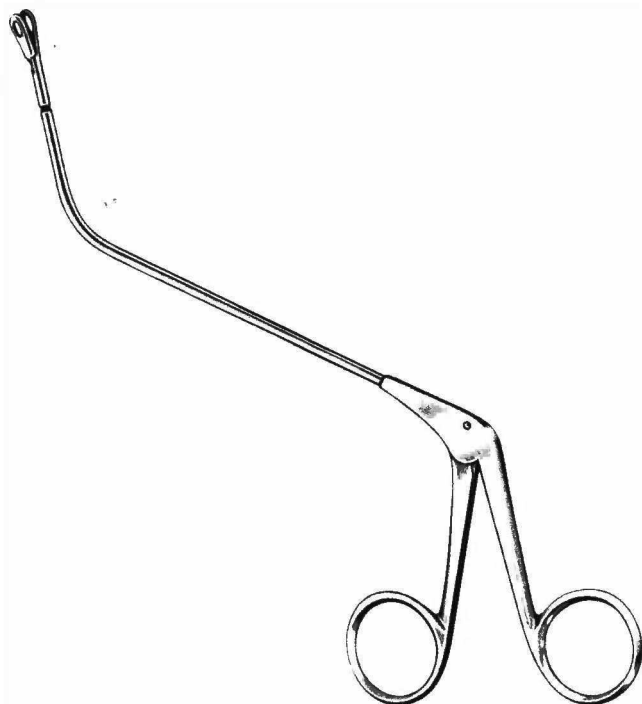

JATHO  
H146-59515

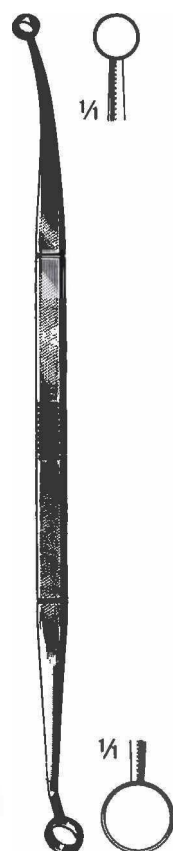

FAULKNER  
H146-60121  
21 cm

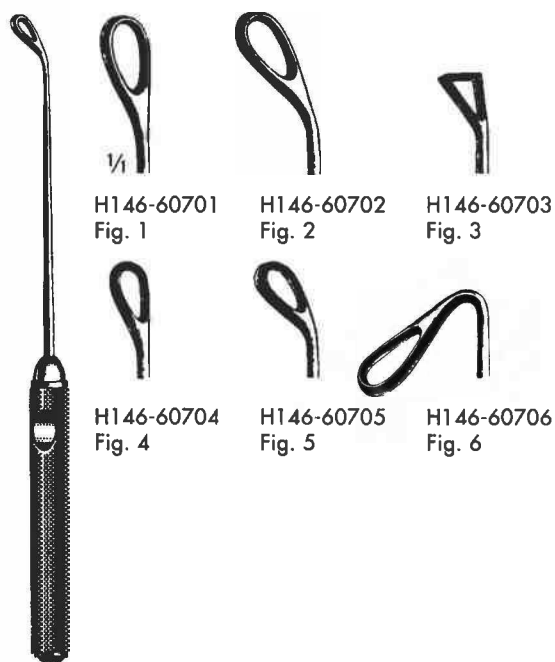

COAKLEY  
H146-60701 - H146-60706  
17 cm



H146-62001  
Fig. 1



H146-62002  
Fig. 2

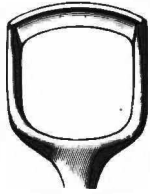

H146-62003  
Fig. 3

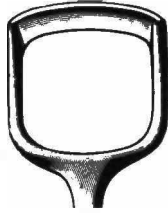

H146-62004  
Fig. 4



H146-62005  
Fig. 5



H146-62006  
Fig. 6

BECKMANN  
H146-62001 - H146-62006  
22 cm



H146-63001  
Fig. 1



H146-63002  
Fig. 2



H146-63003  
Fig. 3

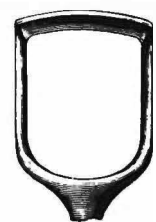

H146-63004  
Fig. 4

BARNHILL  
H146-63001 - H146-63004  
21 cm

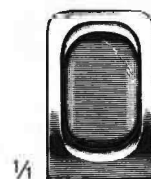
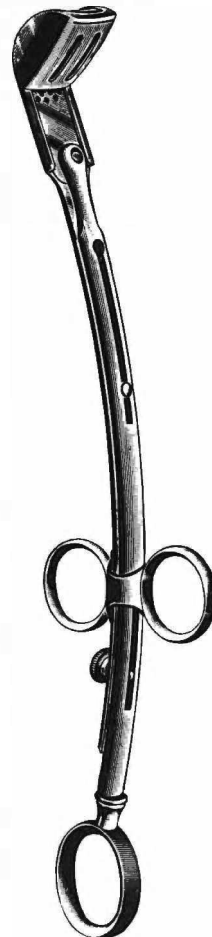

H146-64101  
Fig. 1

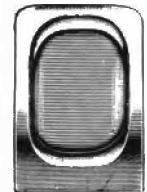

H146-64102  
Fig. 2

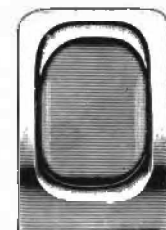

H146-64103  
Fig. 3

Ersatzklingen, gelocht  
Spare blades, perforated  
Lames de rechange, perforées  
Hojas de repuesto, perforadas  
Lame di ricambio, forate

Fig.	
1	H146-64201
2	H146-64202
3	H146-64203

LAFORCE  
H146-64101 - H146-64103  
25 cm



H146-63601  
Fig. 1



H146-63603  
Fig. 3



H146-63602  
Fig. 2



H146-63604  
Fig. 4

St. CLAIR-THOMSON  
H146-63601 - H146-63604  
21 cm

Mund und Zunge  
Mouth and Tongue  
Bouche et langue  
Boca y lengua  
Bocca e lingua

Zungenspatel, Lippenhalter  
Tongue Depressors, Lip Retractors  
Abaisse-langue, écarteurs des lèvres  
Abajalengua, Separadores de labios  
Abbassalingua, Divaricatori di labbra

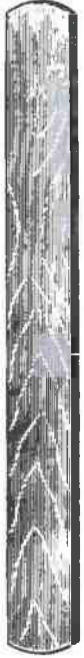

H148-10216  
16 cm  
Holz · wood · bois  
madera · legno

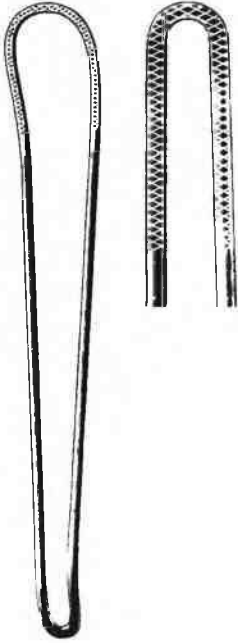

FRENZEL  
H148-10516  
16,5 cm



BRUENINGS  
H148-10719  
19 cm

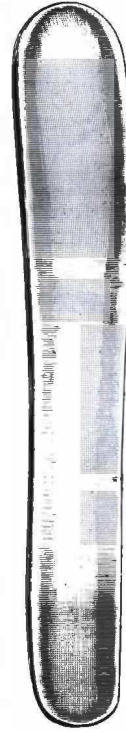

BUCHWALD  
H148-10919  
19 cm



HARTMANN  
H148-11115  
15 cm

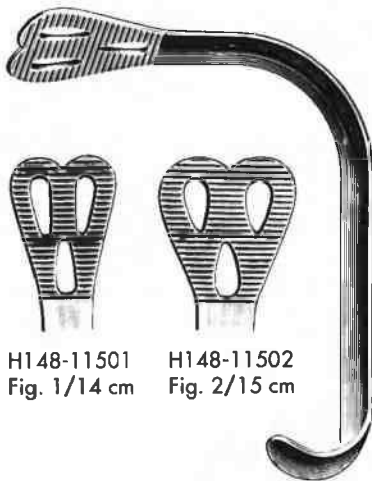

H148-11501 Fig. 1/14 cm  
H148-11502 Fig. 2/15 cm

WIEDER  
H148-11501 - H148-11502



ANDREW  
H148-11711  
11 cm

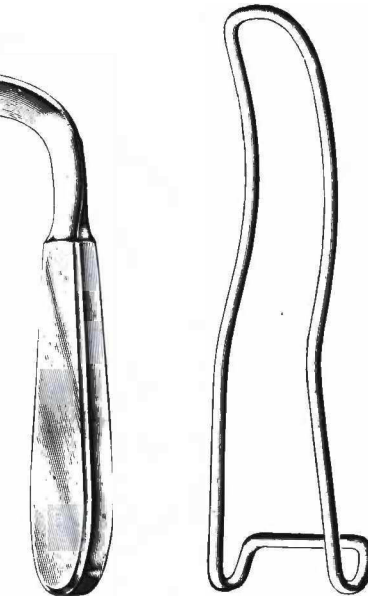

TOBOLD  
H148-11914  
14,5 cm

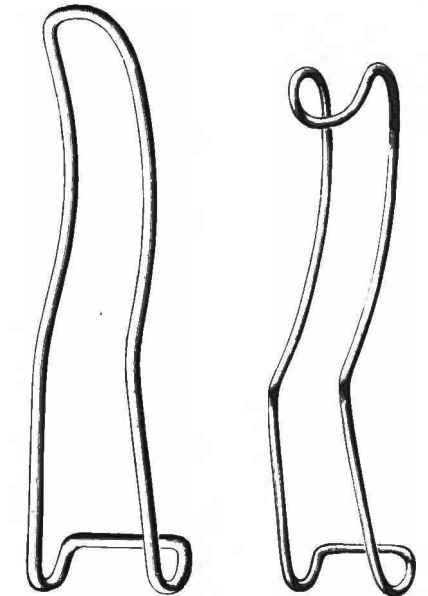

cm	STERNBERG	cm	STERNBERG
14	H148-22714	12	H148-22912
16	H148-22716	14	H148-22914
18	H148-22718	16	H148-22916

Zungenzangen · Tongue Holding Forceps  
Pincés tire-langue · Pinzas tiralingua  
Pinze tirilingua

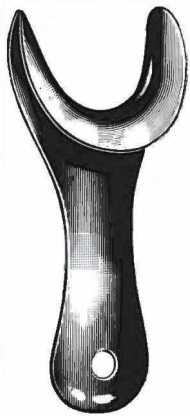

H148-23011  
11 cm

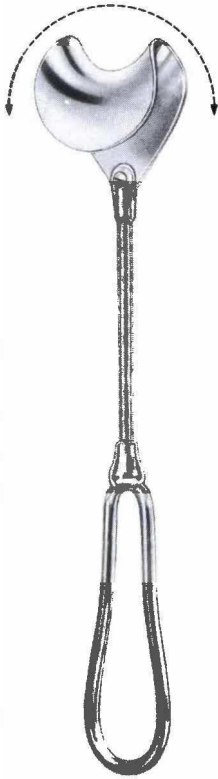

H148-23519  
19 cm

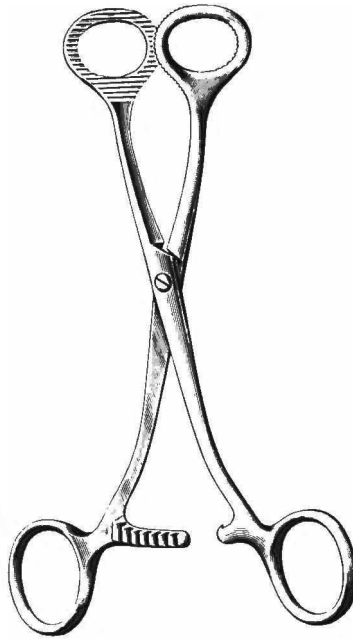

cm COLLIN  
16 H148-25016  
18 H148-25018

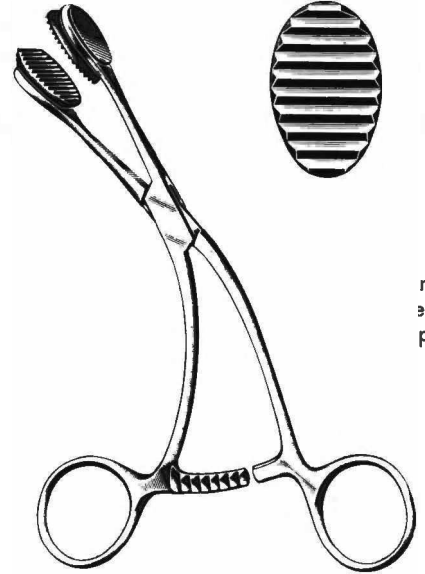

YOUNG  
H148-25516  
16 cm

re)  
eja)  
pia)

Mundsperrer · Mouth Gags  
Ouvre-bouche · Abrebocas  
Apribocca

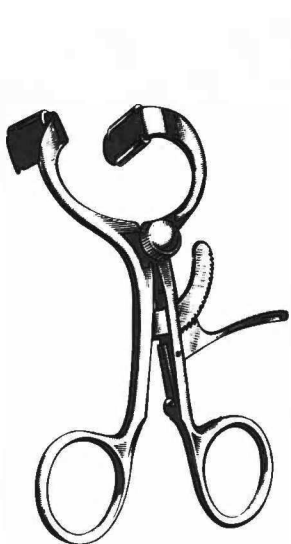

DOYEN-JANSEN (MOLT)  
H148-26512  
12 cm

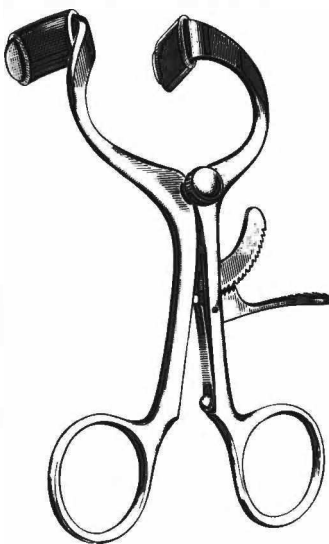

DOYEN-JANSEN (MOLT)  
H148-26514  
14 cm

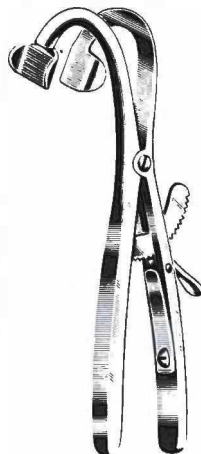

DENHART  
H148-26712  
12 cm

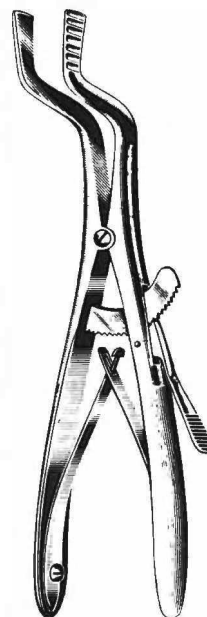

cm ROSER-KOENIG  
16 H148-27016  
19 H148-27019

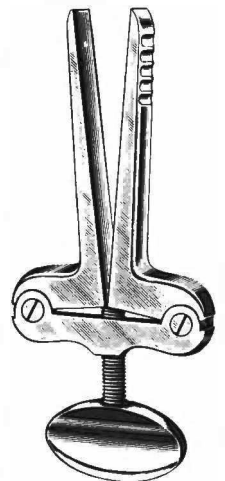

HEISTER  
H148-27213  
13 cm



Mund und Zunge  
Mouth and Tongue  
Bouche et langue  
Boca y lengua  
Bocca e lingua

Mundsperrer · Mouth Gags  
Ouvre-bouche · Abrebocas  
Apribocca

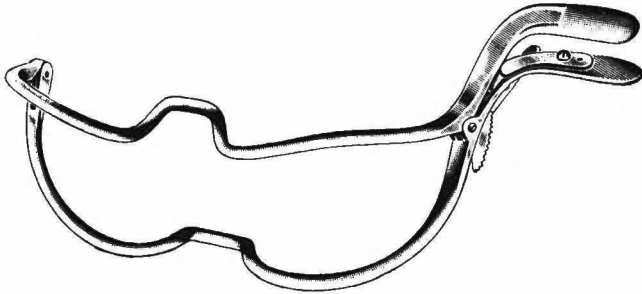

cm	JENNINGS
9	H148-27409
11	H148-27411
13	H148-27413
15	H148-27415

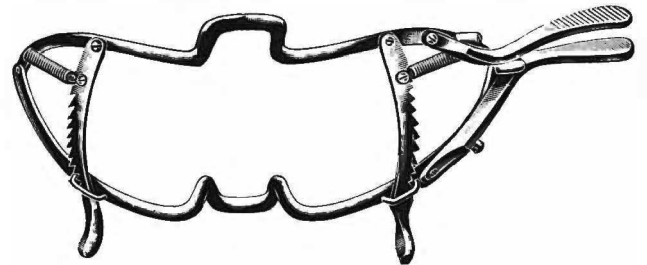

cm	WHITEHEAD
11	H148-28011
13	H148-28013
15	H148-28015



cm	WHITEHEAD
11	H148-28111
13	H148-28113
15	H148-28115

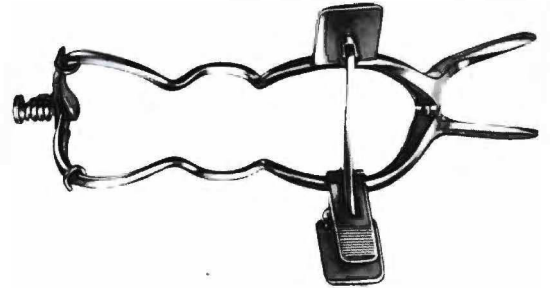

cm	SEEMANN-SEIFFERT
9	H148-28509
11	H148-28511
13	H148-28513
15	H148-28515

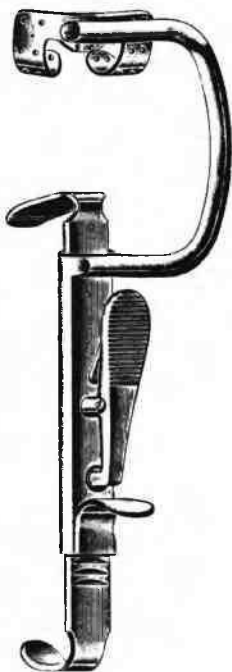

H148-31010

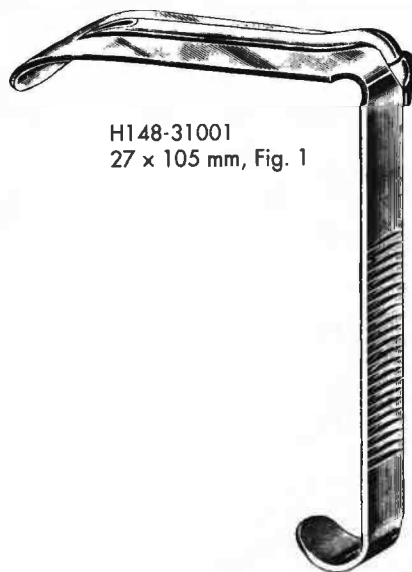

H148-31001  
27 x 105 mm, Fig. 1

DAVIS-BOYLE  
H148-31000  
compl.

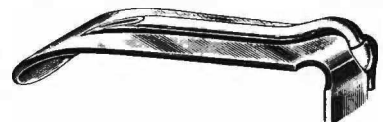

H148-31002  
25 x 90 mm, Fig. 2



H148-31003  
25 x 75 mm, Fig. 3



H148-31004  
22 x 60 mm, Fig. 4



H148-31005  
20 x 25 mm, Fig. 5



Mundsperrer · Mouth Gags  
Ouvre-bouche · Abrebocas  
Apribocca



KILNER-DOUGHTY  
H148-31500  
compl.

frame only  
H148-31510

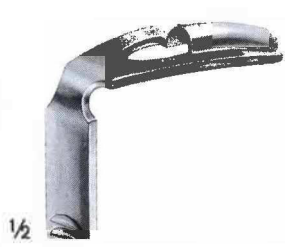

1/2  
H148-31501  
28 x 65 mm  
Fig. 1

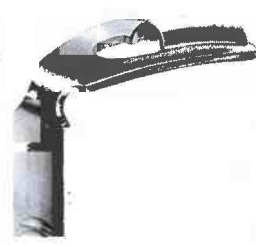

H148-31502  
32 x 75 mm  
Fig. 2



H148-31503  
37 x 80 mm  
Fig. 3



H148-32010  
single handle

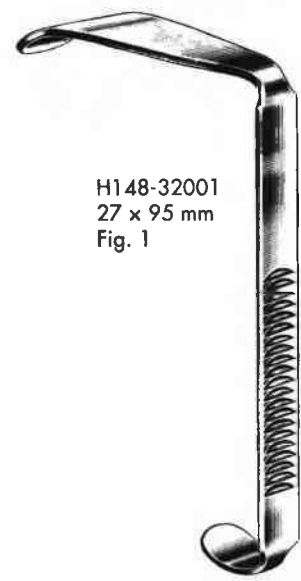

H148-32001  
27 x 95 mm  
Fig. 1

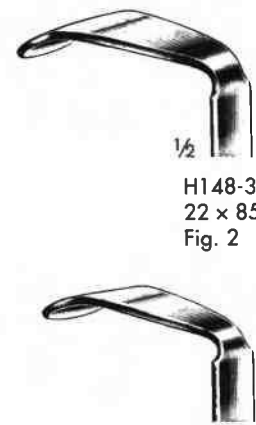

1/2  
H148-32002  
22 x 85 mm  
Fig. 2

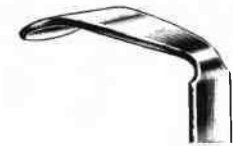

H148-32003  
22 x 70 mm  
Fig. 3

McIVOR  
H148-32000  
compl.

Mund  
Mouth  
Bouche  
Boca  
Bocca

148



MAUNDER  
H148-36010



PITHA  
H148-36510

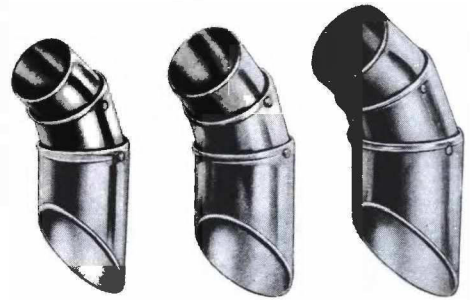

LANGENBECK	
H148-37101	H148-37102
Fig. 1	Fig. 2
	H148-37103
	Fig. 3



links  
left side  
côté gauche  
izquierda  
lato sinistro

chts  
ght side  
té droite  
recha  
to destro

cm	ROWE	ROWE	
22,5	H148-50122	H148-50322	Säugling · baby · bébé · bebé · lattante
23,5	H148-50123	H148-50323	Kinder · child · enfant · niño · bambino
24,0	H148-50124	H148-50324	Erwachsene · adult

Tonsillen  
Tonsils  
Amygdales  
Amígdalas  
Tonsille



cm	LOVE
18	H150-10318
20	H150-10320
22	H150-10322

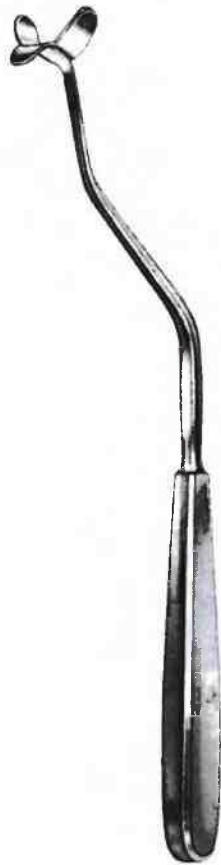

HOFFER  
H150-10924  
24 cm



NAGER  
H150-11123  
23 cm



HURD  
H150-13122  
glatt · smooth · lisse  
liso · liscio  
22 cm

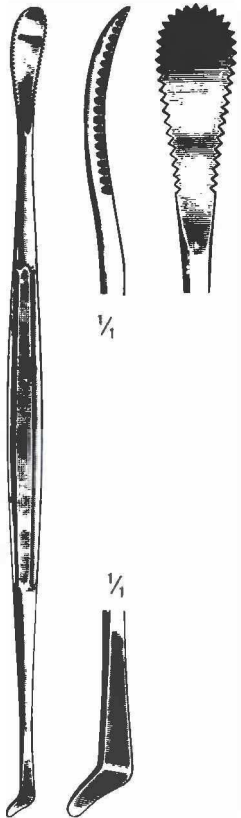

HENKE  
H150-13523  
23 cm



CARPENTER  
H150-13925  
25 cm

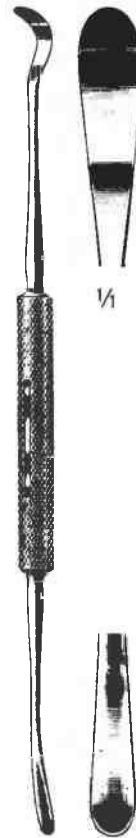

CARPENTER  
H150-14324  
24 cm



LUNIATSCHEK  
H150-15119  
19 cm

H150-13322  
gezahnt · serrated  
dentelé · dentado  
dentellato  
22 cm

Tonsillen  
Tonsils  
Amygdales  
Amígdalas  
Tonsille

150

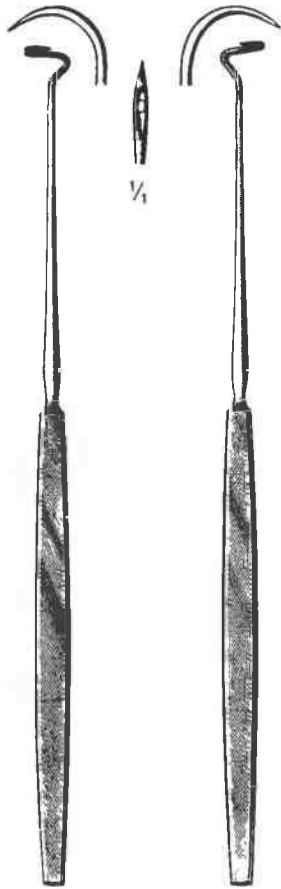

DUPUY-WEISS  
H150-16522 H150-16722  
22 cm

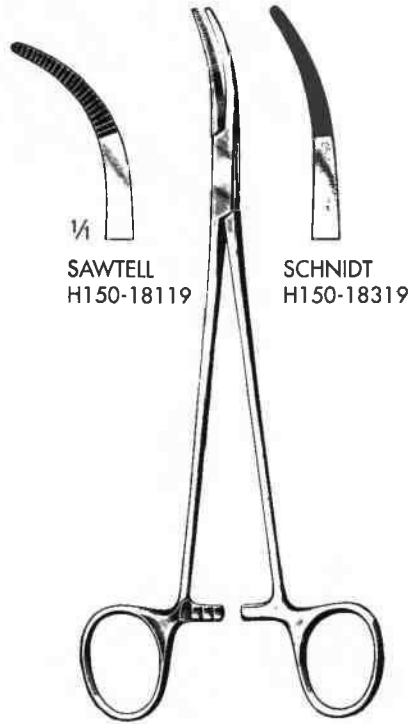

SAWTELL H150-18119  
SCHNIDT H150-18319

H150-18119 - H150-18319  
19 cm

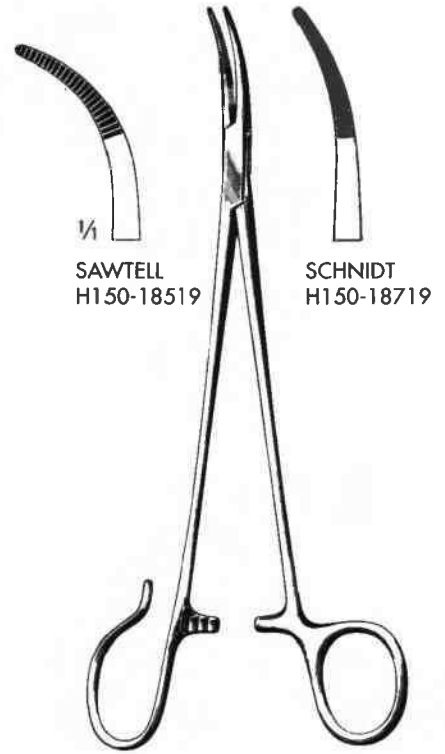

SAWTELL H150-18519  
SCHNIDT H150-18719

H150-18519 - H150-18719  
19 cm

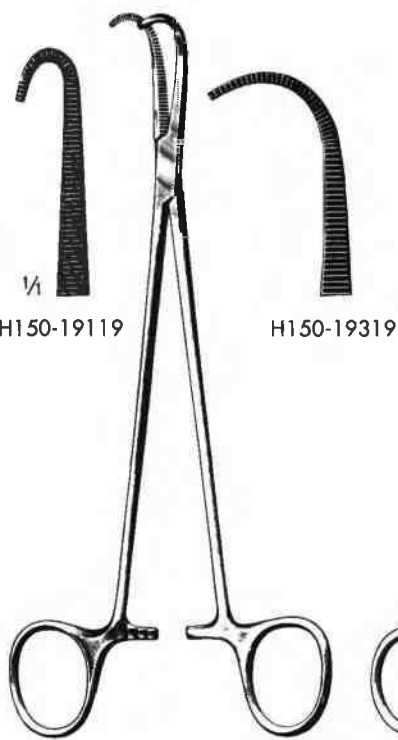

NEGUS H150-19119  
COLVER H150-19319

NEGUS  
H150-19119 - H150-19319  
19 cm

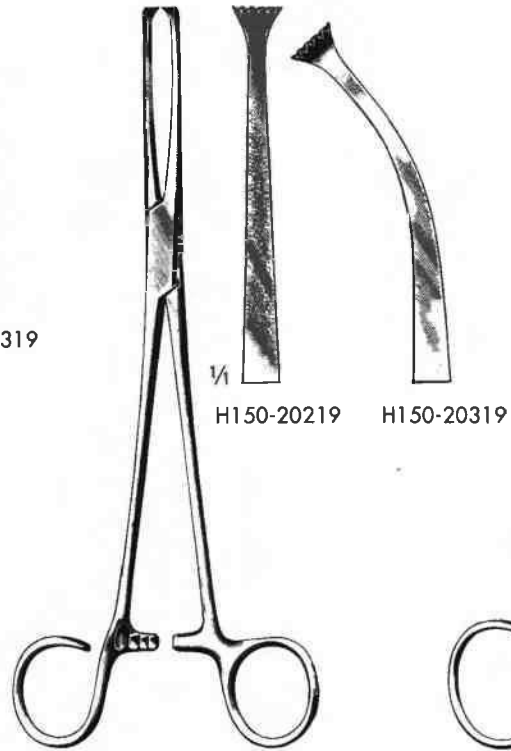

COLVER H150-20219  
WHITE H150-20319

COLVER  
H150-20219 - H150-20319  
19 cm

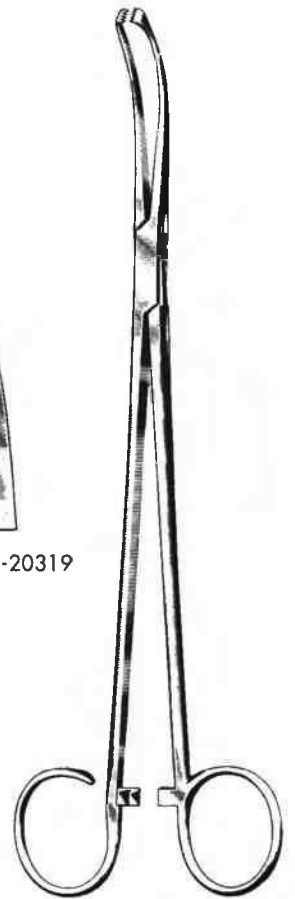

cm	WHITE
18	H150-20518
23	H150-20523

Tonsillen  
Tonsils  
Amygdales  
Amígdalas  
Tonsille

150

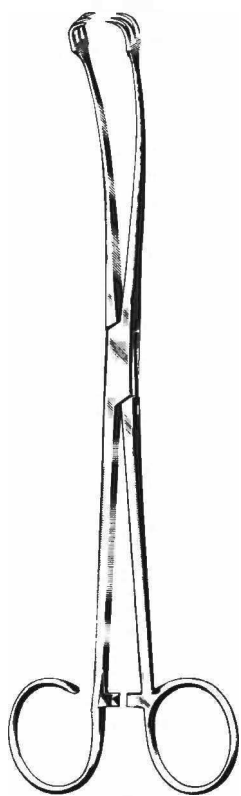

**BALLENGER**  
H150-20721  
21,5 cm

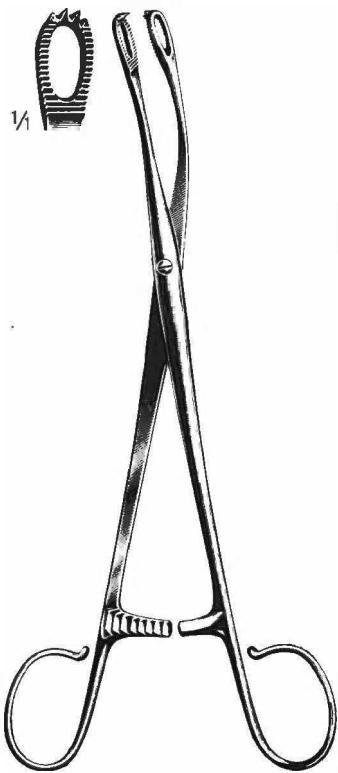

**BLOHMKE**  
H150-20920  
20 cm

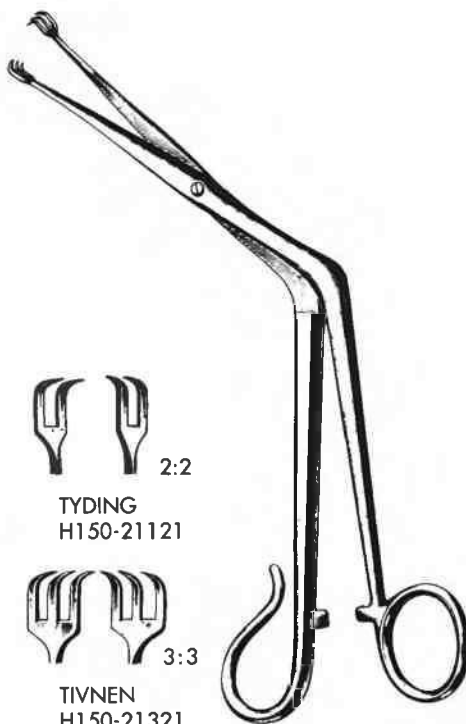

2:2  
**TYDING**  
H150-21121

3:3  
**TIVNEN**  
H150-21321

H150-21121 - H150-21321  
21 cm

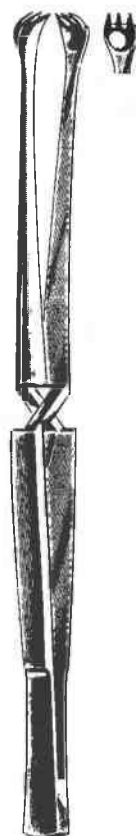

**MARSCHIK**  
H150-21922  
22 cm

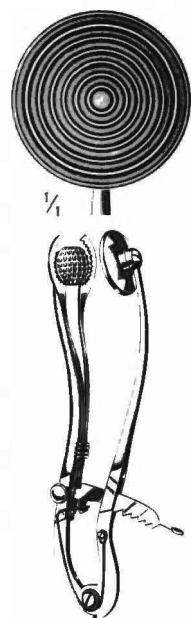

**CORWIN**  
H150-23114  
14 cm



**EVES**  
H150-25028  
28 cm

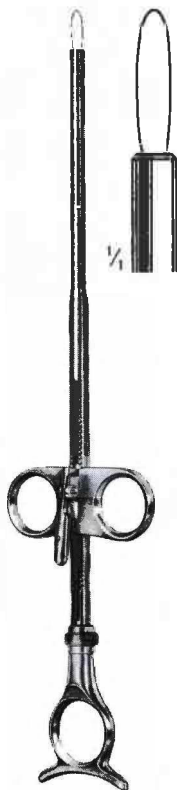

**EVES**  
H150-25228  
28 cm



**BRUENINGS**  
H150-25628  
28 cm



mm	100 x	H150-25903
40	H150-25740	0,3 mm
50	H150-25750	12 x



Tonsillen  
Tonsils  
Amygdales  
Amígdalas  
Tonsille

150

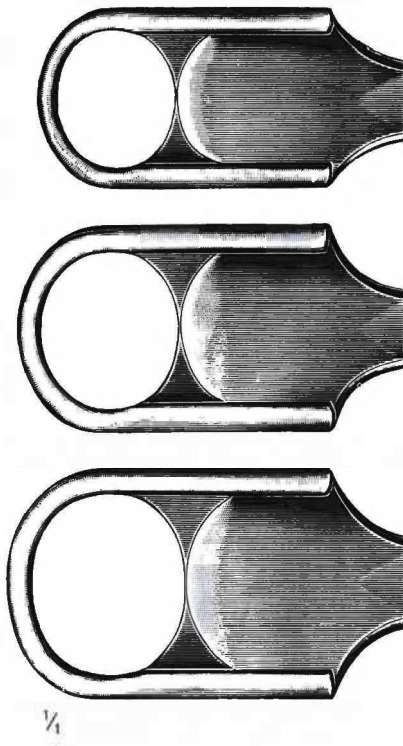

H150-29200

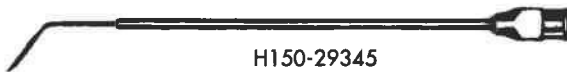

H150-29345  
45°

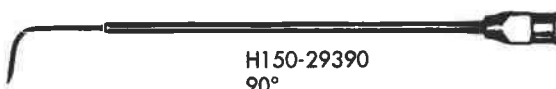

H150-29390  
90°

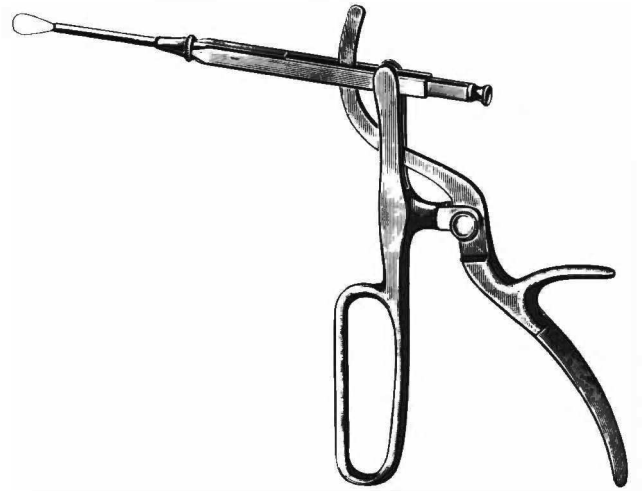

TYDING  
H150-26000  
mit 1 geraden Aufsatz  
with 1 straight tip  
à 1 embout droit  
con 1 punta recta  
con 1 punta retta



SLUDER-BALLENGER  
H150-27000  
mit 3 Aufsätzen  
with 3 blades  
avec 3 lames  
con 3 hojas  
con 3 lame

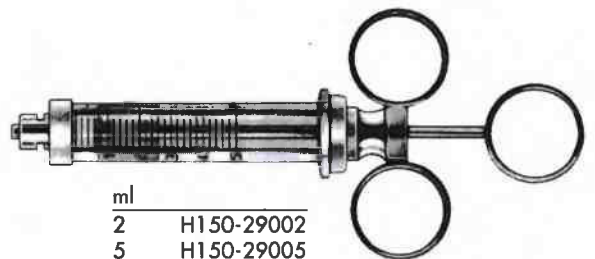

ml	
2	H150-29002
5	H150-29005
10	H150-29010

Kehlkopf  
Larynx  
Larynx  
Laringe  
Laringe

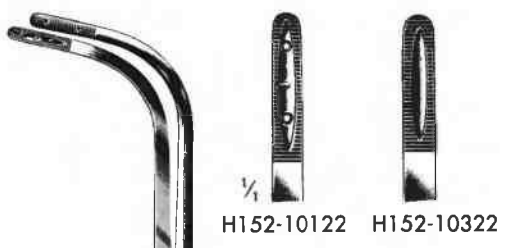

JACKSON  
H152-10122 - H152-10322  
22 cm

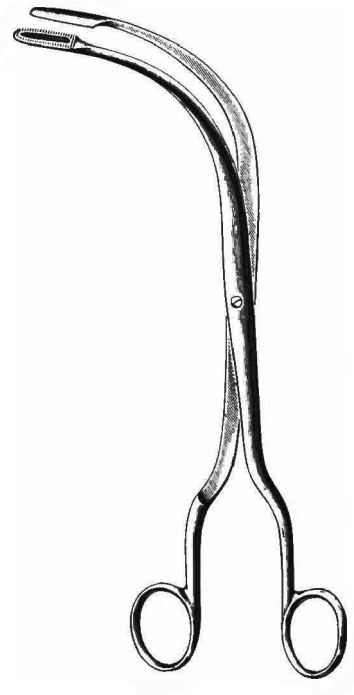

FRAENKEL  
H152-11118  
18 cm

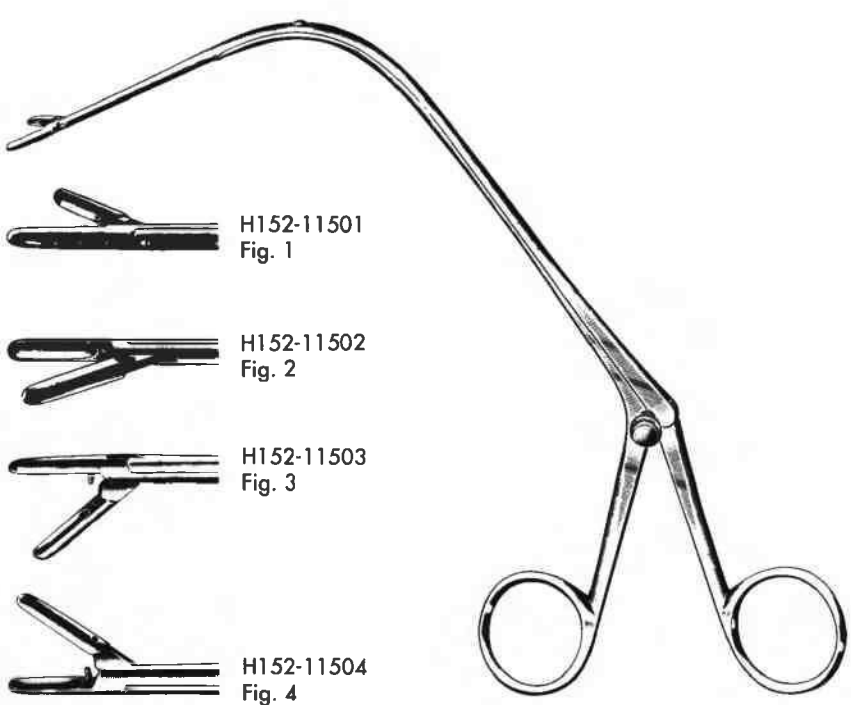

JURASZ  
H152-11501 - H152-11504  
23 cm

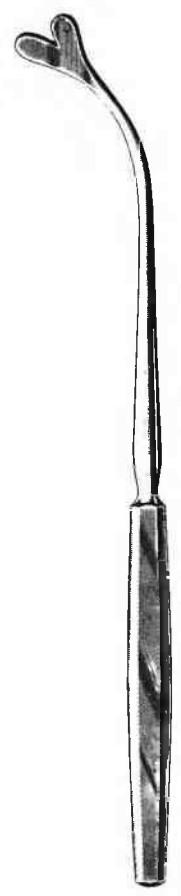

REICHERT  
H152-12124  
24 cm

Kehlkopf  
Larynx  
Larynx  
Larynx  
Larynx

152



HUBER  
H152-13000

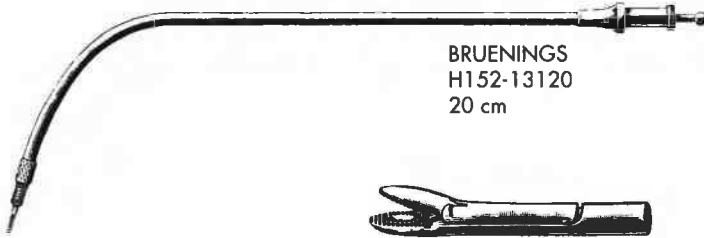

BRUENINGS  
H152-13120  
20 cm

cm	BRUENINGS
20	H152-13220
30	H152-13230
40	H152-13240
50	H152-13250
60	H152-13260



FRAENKEL  
H152-15000



SEIFFERT  
H152-15200



FRAENKEL  
H152-15400



SCHEINMANN  
H152-15500



SCHEINMANN  
H152-15700

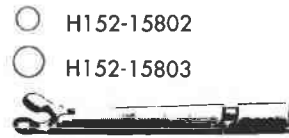

BRUENINGS  
H152-15802 - H152-15803

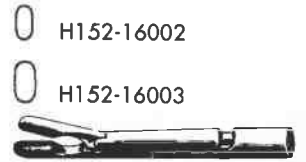

BRUENINGS  
H152-16002 - H152-16003



LANGE  
H152-16200

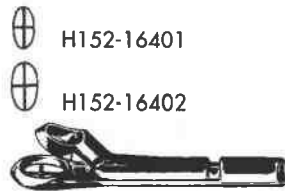

KRAUSE  
H152-16401 - H152-16402



KRAUSE  
H152-16600

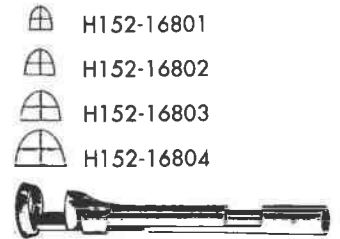

CORDES  
H152-16801 - H152-16804



SCHUMACHER  
H152-17000

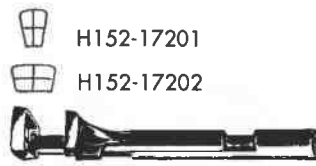

CORDES  
H152-17201 - H152-17202



CORDES  
H152-17400



ROSENBERG  
H152-17600

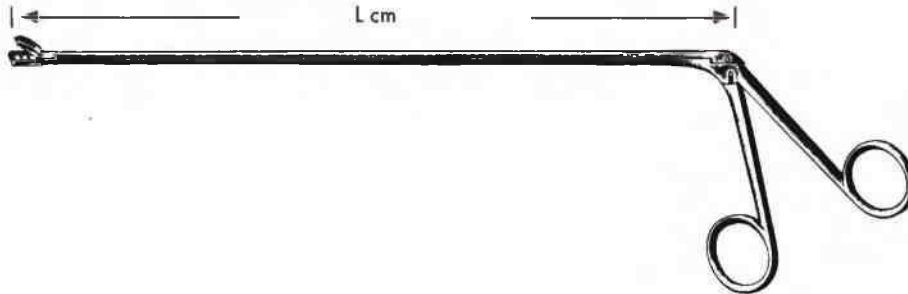

CHEVALIER-JACKSON  
H152-23001 - H152-26007



cm	Fig. 1	Fig. 2	Fig. 3	Fig. 4	Fig. 5	Fig. 6	Fig. 7
30	H152-23001	H152-23002	H152-23003	H152-23004	H152-23005	H152-23006	H152-23007
40	H152-24001	H152-24002	H152-24003	H152-24004	H152-24005	H152-24006	H152-24007
50	H152-25001	H152-25002	H152-25003	H152-25004	H152-25005	H152-25006	H152-25007
60	H152-26001	H152-26002	H152-26003	H152-26004	H152-26005	H152-26006	H152-26007



H152-27008 - H152-27030



	Fig.	mm Ø	
H152-27008	00	8	H152-27208
H152-27010	0	10	H152-27210
H152-27012	1	12	H152-27212
H152-27014	2	14	H152-27214
H152-27016	3	16	H152-27216
H152-27018	4	18	H152-27218
H152-27020	5	20	H152-27220
H152-27022	6	22	H152-27222
H152-27024	7	24	H152-27224
H152-27026	8	26	H152-27226
H152-27028	9	28	H152-27228
H152-27030	10	30	H152-27230



H152-27208 - H152-27230



H152-27412



H152-27610

Gastroskopie  
Gastroscoy  
Gastroscoyie  
Gastroscoyía  
Gastroscoyia

Flexible Zangen  
Flexible Forceps  
Pinces flexibles  
Pinzas flexibles  
Pinze flessibili

153



Ø 1,8 mm

Ø 2,2 mm

Ø 2,6 mm

Ø 3,4 mm



L cm

160	H153-11016
160	H153-11026
230	H153-11023
230	H153-11033

160	H153-12016
160	H153-12026
230	H153-12023
230	H153-12033

160	H153-13016
230	H153-13023

160	H153-14016
230	H153-14023



L cm

160	H153-11116
160	H153-11126
230	H153-11123
230	H153-11133

160	H153-12116
160	H153-12126
230	H153-12123
230	H153-12133

160	H153-13116
230	H153-13123

160	H153-14116
230	H153-14123



L cm

160	H153-11216
160	H153-11226
230	H153-11223
230	H153-11233

160	H153-12216
160	H153-12226
230	H153-12223
230	H153-12233

160	H153-14216
230	H153-14223



L cm

160	H153-11316
160	H153-11326
230	H153-11323
230	H153-11333

160	H153-12316
160	H153-12326
230	H153-12323
230	H153-12333

160	H153-14316
230	H153-14323



Flexible Zangen, isoliert  
Flexible Forceps, insulated  
Pinces flexibles isolées  
Pinzas flexibles aisladas  
Pinze flessibili isolate

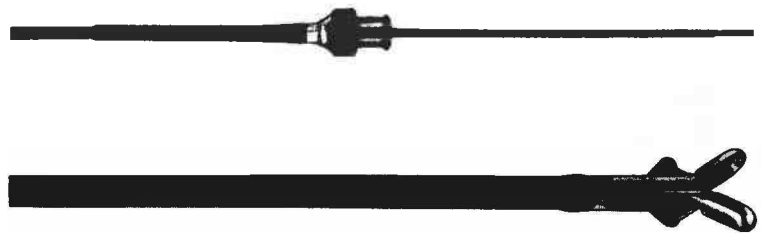

Ø 1,8 mm

Ø 2,2 mm

Ø 2,6 mm

Ø 3,4 mm



L cm

160 H153-21216  
230 H153-21223

H153-22216  
H153-22223

H153-23216  
H153-23223

H153-24216  
H153-24223

Gastroskopie  
Gastroscoopy  
Gastroscopie  
Gastroscopia  
Gastroscopia

153

Ø 2,2 mm

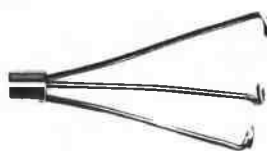

L cm	
160	H153-29116
230	H153-29123

Flexible Zangen  
Flexible Forceps  
Pinces flexibles  
Pinzas flexibles  
Pinze flessibili

Ø 1,8 mm



L cm	
160	H153-29216
230	H153-29223

verjüngt · tapered



		L cm	
H153-30126	H153-30116	160	H153-34116
H153-30133	H153-30123	230	H153-34123



		L cm	
H153-30226	H153-30216	160	H153-34216
H153-30233	H153-30223	230	H153-34223



L cm	
160	H153-34316
230	H153-34323



		L cm	
H153-30416		160	H153-34416
H153-30423		230	H153-34423



		L cm	
H153-31116		160	H153-35116
H153-31123		230	H153-35123



		L cm	
H153-31216		160	H153-35216
H153-31223		230	H153-35223



		L cm	
H153-31316		160	H153-35316
H153-31323		230	H153-35323

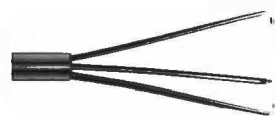

		L cm	
H153-31416		160	H153-35416
H153-31423		230	H153-35423



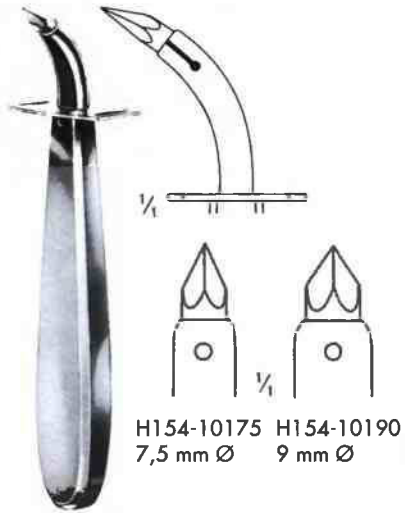

H154-10175 H154-10190  
7,5 mm Ø 9 mm Ø

UCKERMANN  
H154-10175 - H154-10190  
13 cm

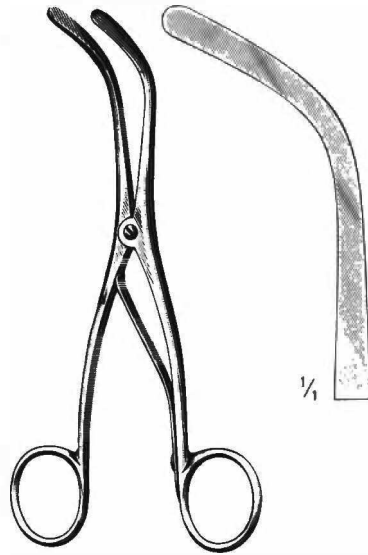

TROUSSEAU  
H154-11114  
14 cm

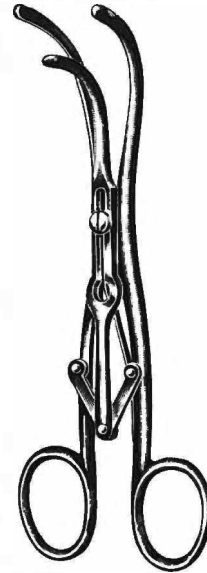

LABORDE  
H154-11314  
14 cm



BOSE  
H154-11507  
7 cm

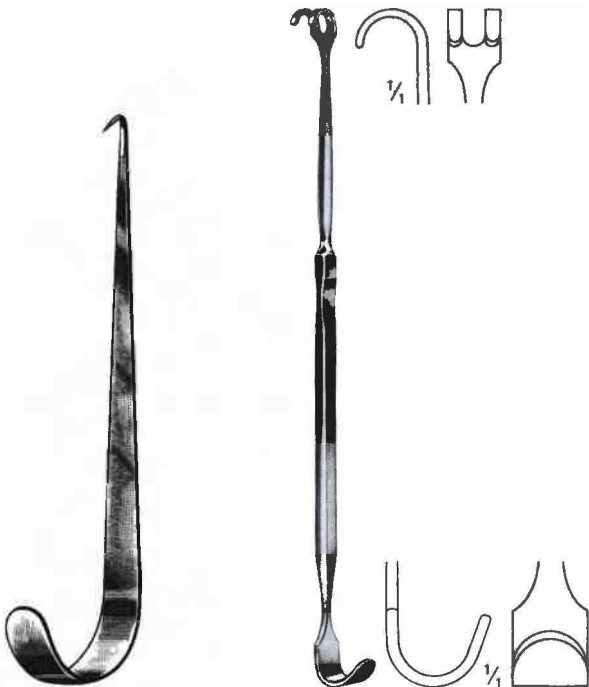

JACKSON  
H154-11615  
15 cm



JACKSON  
H154-11717  
17 cm



ITERSON  
H154-11816 - H154-11916  
16 cm

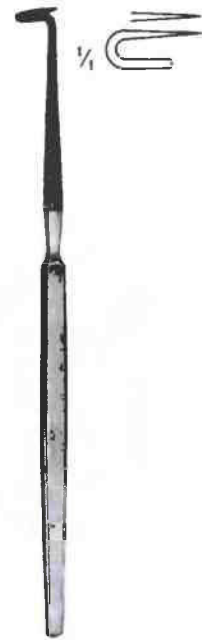

BOSE  
H154-12216  
16 cm



BOSE  
H154-12416  
16 cm

Tracheotomie  
Tracheostomy  
Trachéotomie  
Traqueotomía  
Tracheotomia

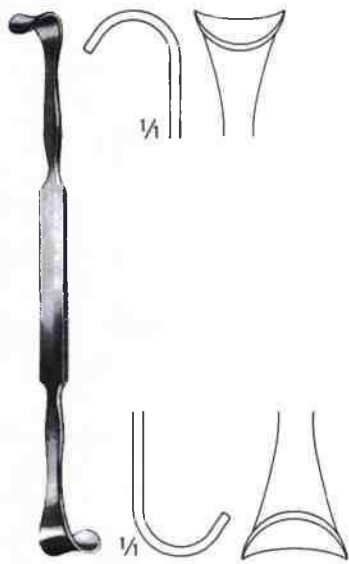

ROSE  
H154-13013  
13 cm



mm	WAGENER-MOSHER
5	H154-15105
7	H154-15107
9	H154-15109



H154-27000



Fig.	mm	LUER
0	4	H154-22004
1	5	H154-22005
2	6	H154-22006
3	7	H154-22007
4	8	H154-22008
5	9	H154-22009
6	10	H154-22010
7	11	H154-22011
8	12	H154-22012
9	13	H154-22013



Fig.	mm	JACKSON
0	4	H154-24004
1	5	H154-24005
2	6	H154-24006
3	7	H154-24007
4	8	H154-24008
5	9	H154-24009
6	10	H154-24010
7	11	H154-24011
8	12	H154-24012
9	13	H154-24013

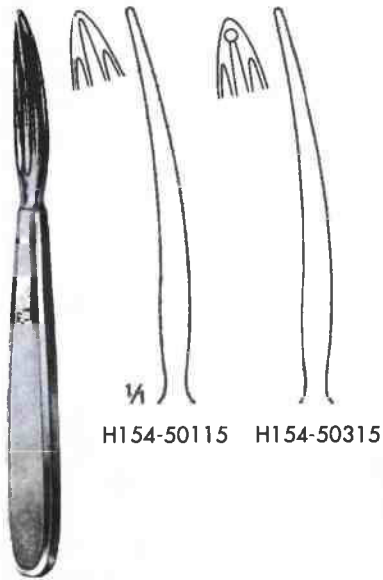

H154-50115 H154-50315

KOCHER  
H154-50115 - H154-50315  
15 cm



SCHOENBORN  
H154-51121  
21 cm



cm	LAHEY
15	H154-52015
20	H154-52020

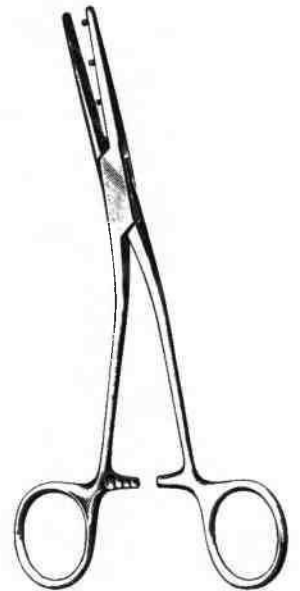

MASTIN  
H154-52317  
17 cm



Thorax  
Thorax  
Thorax  
Tórax  
Torace

Rippenscheren  
Rib Shears  
Costotomes  
Costótomos  
Costotomi



H156-10223  
23 cm



H156-10522  
22 cm



GLUCK  
H156-10722  
22 cm



STILLE  
H156-11121  
21 cm

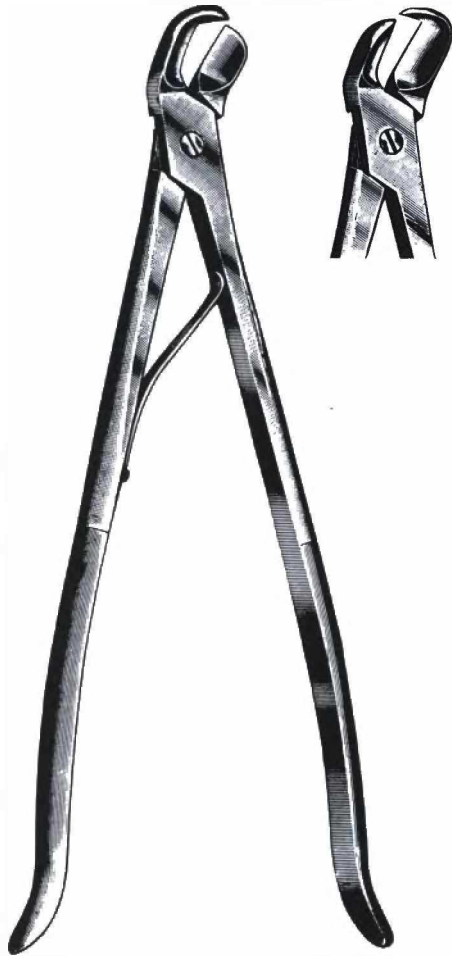

CORYLLOS  
H156-12335  
35 cm



BETHUNE  
H156-12634  
34 cm



SAUERBRUCH  
H156-13126



GIERTZ-STILLE  
H156-13727  
27 cm



SAUERBRUCH-FREY  
H156-14136  
36 cm

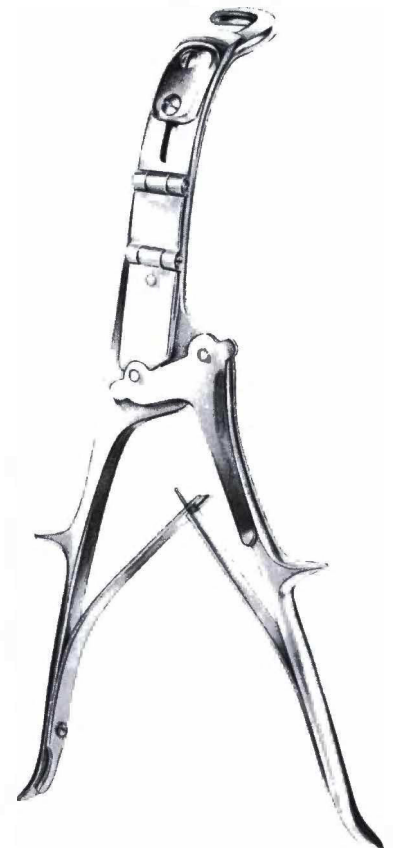

BRUNNER  
H156-14728  
28 cm

Thorax  
Thorax  
Thorax  
Tórax  
Torace

Rippensperrer  
Rib Spreaders  
Ecarteurs des côtes  
Separadores costales  
Divaricatori costali

156



Blatt · Blade · Valve  
Hoja · Valva

Spreizung Spread Ecartement Abertura Apertura A	Tiefe Depth Profondité Profundidad Profondità B	Breite Width Largeur Ancho Larghezza C
--	--	---

FINOCHIETTO	A=mm	B=mm	C=mm
H156-21016	165	40	40
H156-21020	200	45	55
H156-21025	250	70	65

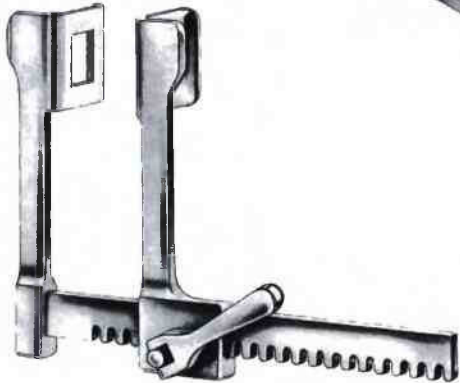

FINOCHIETTO-Baby	A=mm	B=mm	C=mm
H156-21475	75	18	20



Aluminium

FINOCHIETTO-Infant	A=mm	B=mm	C=mm
H156-23475	75	15	15



Aluminium

FINOCHIETTO	A=mm	B=mm	C=mm
H156-23013	135	38	44
H156-23017	175	52	62
H156-23018	175	85	65

Rippensperrer  
Rib Spreaders  
Ecarteurs des côtes  
Separadores costales  
Divaricatori costali

70 x 65 mm



45 x 65 mm

FINOCHIETTO-BURFORD  
H156-23625  
25 cm



47 x 62 mm



65 x 62 mm

Für Erwachsene  
Adult Size  
pour adultes  
para adultos  
per adulti

Aluminium

FINOCHIETTO-BURFORD  
H156-24218 180 mm  
H156-24226 260 mm  
H156-24230 300 mm



34 x 42 mm



48 x 42 mm

Für Kinder  
Child Size  
pour enfants  
para niños  
per bambini

Aluminium

FINOCHIETTO-BURFORD  
H156-24413  
135 mm

Rippensperrer  
Rib Spreaders  
Ecarteurs des côtes  
Separadores costales  
Divaricatori costali

156

Blatt · Blade · Valve  
Hoja · Valva

Spreizung Spread Ecartement Abertura Apertura A	Tiefe Depth Profondité Profundidad Profondità B	Breite Width Largeur Ancho Larghezza C
--	--	---

Aluminium



H156-25006



H156-25007



H156-25012

CASTAÑEDA	A=mm	B=mm	C=mm
H156-25006	65	10,5	32
H156-25007	70	12,0	45
H156-25012	120	15,0	60

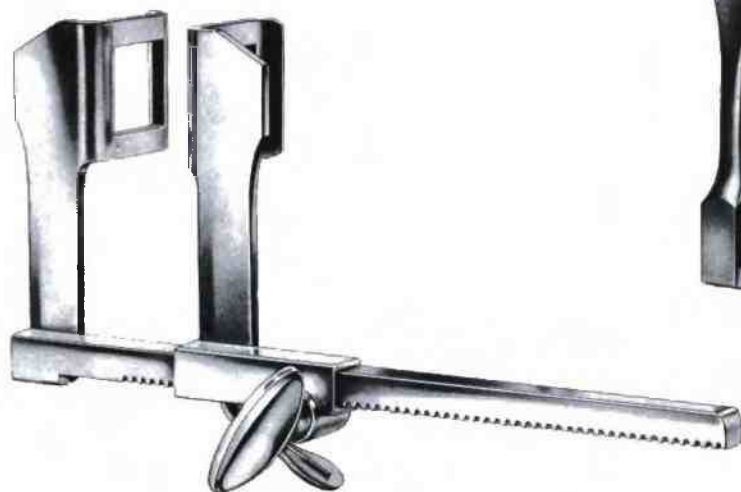

HAIGHT	A=mm	B=mm	C=mm
H156-26009	90	30	30



TUFFIER	A=mm	B=mm	C=mm
H156-26416	165	50	45



Thorax  
Thorax  
Thorax  
Tórax  
Torace

156

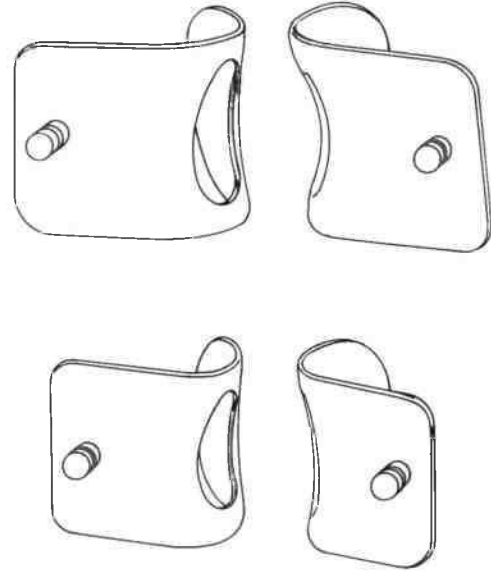

75 x 75 mm

42 x 65 mm

"Mercedes" compl.  
H156-27000



H156-28019



BAILEY-Baby  
H156-28214

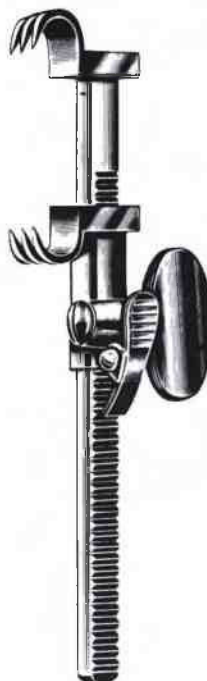

BAILEY  
H156-28416

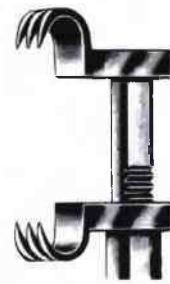

BAILEY-GIBBON  
H156-28616



ALLISON  
H156-28932  
32 cm

Lunge  
Lung  
Poumon  
Pulmón  
Polmone

Bronchus-Klemmen · Bronchus Forceps  
Pincas clamps pour les bronches  
Pinzas clamps bronquiales · Pinze per bronchi

Lungenfaßzangen  
Lung Grasping Forceps  
Pincas à saisir le poumon  
Pinzas para coger el pulmón  
Pinze per afferrare il polmone

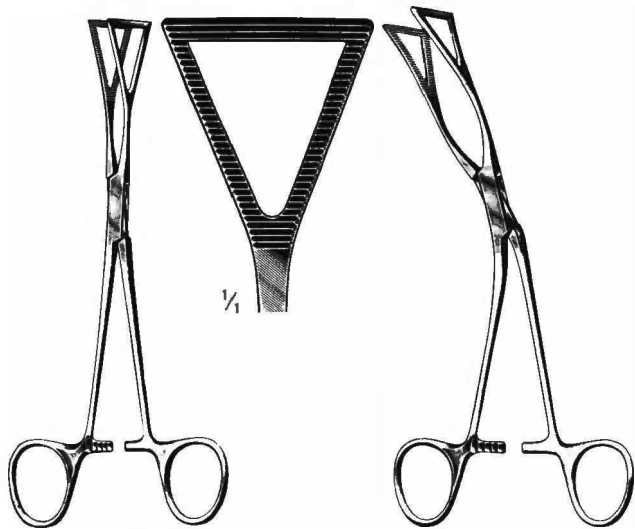

LOVELACE  
H156-29020  
20 cm

LOVELACE  
H156-29120  
20 cm



HARRINGTON  
H156-30130  
30,5 cm

HARRINGTON  
H156-30329  
29,5 cm

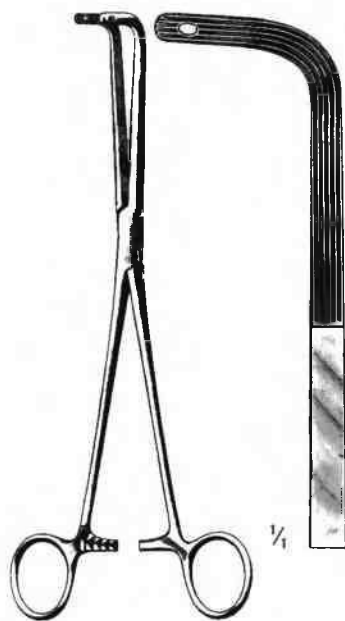

FINOCCHIETTO  
H156-30724  
24 cm

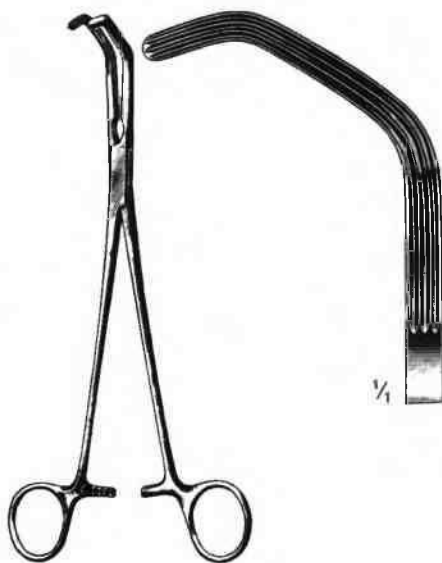

PRICE-THOMAS  
H156-30922  
22 cm

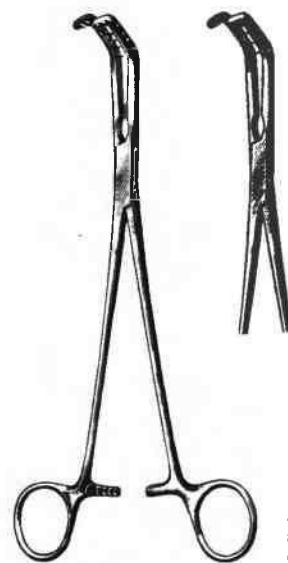

links  
left  
à gauche  
izquierda  
sinistra

H156-31122

PRICE-THOMAS  
22 cm

rechts  
right  
à droite  
derecha  
destra

H156-31322

Bronchus-Klemmen · Bronchus Forceps  
Pinces clamps pour les bronches  
Pinzas clamps bronquiales · Pinze per bronchi



Zahn links  
tooth left  
dent à gauche  
diente a la izquierda  
dente sinistro

**SAROT**

H156-31723

23 cm

Zahn rechts  
tooth right  
dent à droite  
diente a la derecha  
dente destro

H156-31923

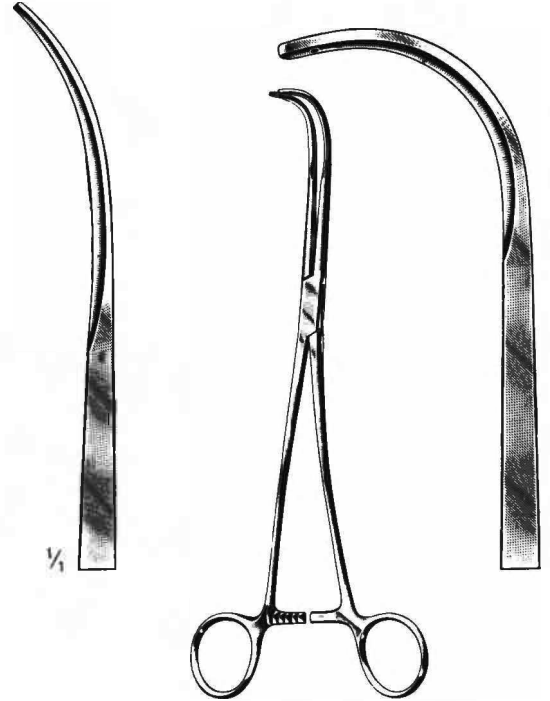

**SEMB**

H156-32123

23 cm

H156-32323

Anastomosen-Klemmen  
Anastomosis Clamps  
Pinces à anastomose  
Pinzas para anastomosis  
Pinze per anastomosi

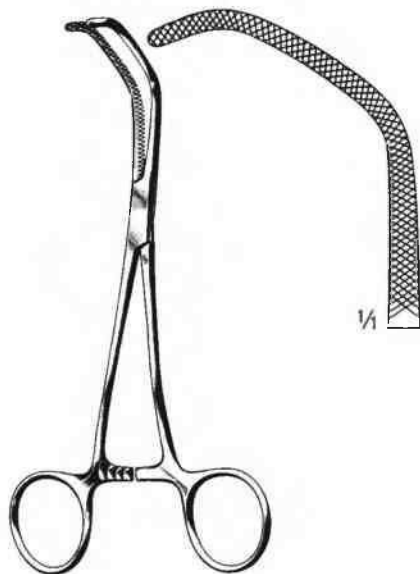

**SATINSKY**  
H156-32515  
15 cm

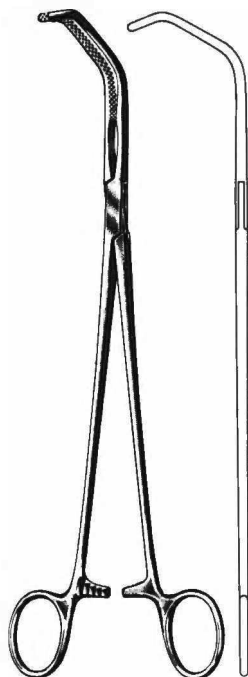

**SATINSKY**  
H156-32726 - H156-32926  
26 cm

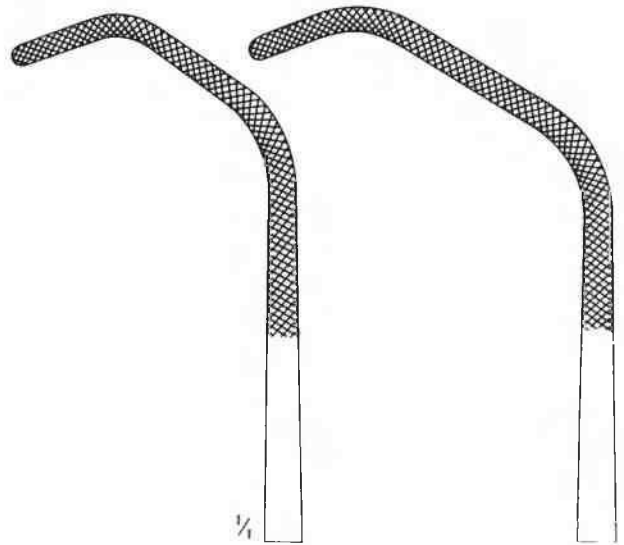

H156-32726  
Fig. 1

H156-32926  
Fig. 2

Galle  
Gall Bladder  
Voies biliaires  
Vesícula biliar  
Vescicola biliare

162



H162-10123 H162-10323  
Fig. 1 Fig. 2

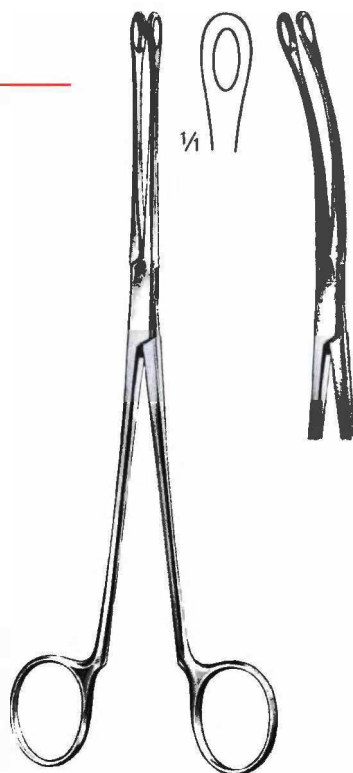

BLAKE  
H162-10620 20 cm H162-10720



MAYO BLAKE  
H162-11020  
20 cm

DESJARDINS  
H162-10123 - H162-11120  
23 cm



MAYO BLAKE  
H162-11120  
20 cm

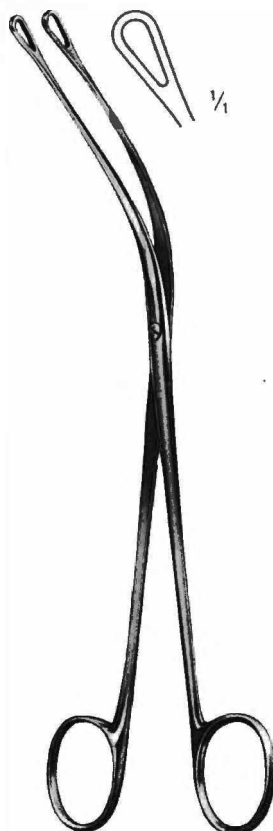

MIXTER  
H162-11722  
22 cm



MOORE  
H162-12528



OCHSNER  
H162-12835

Galle  
Gall Bladder  
Voies biliaires  
Vesícula biliar  
Vescicola biliare

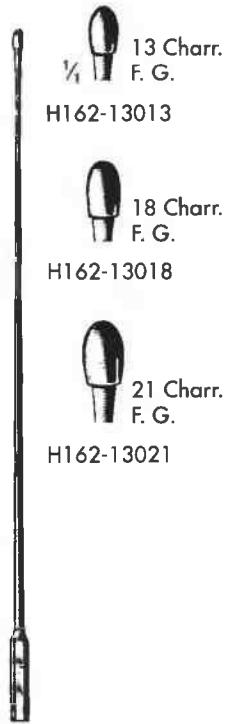

DESJARDINS  
H162-13013 - H162-13021  
28 cm



MOYNIHAN  
H162-14234  
34 cm



BAKES  
H162-15000 - H162-15013  
30 cm

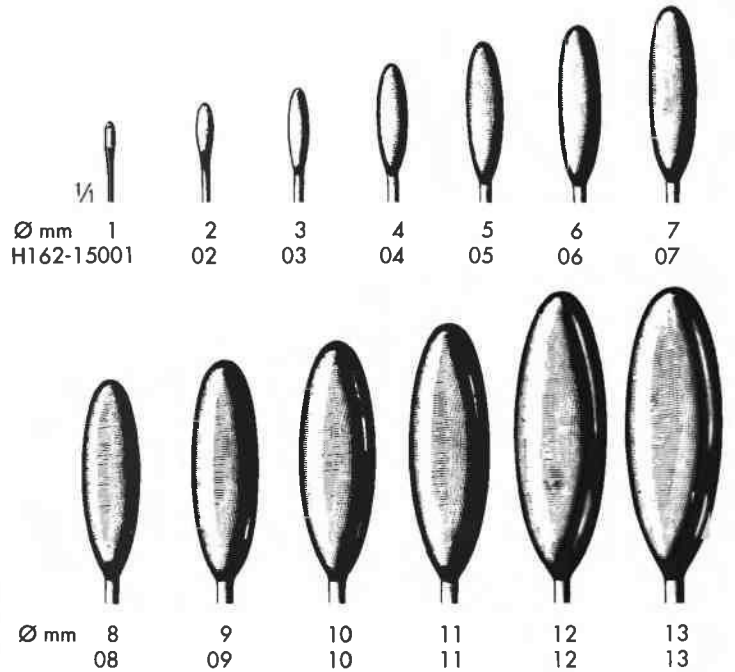

H162-15000 = Set compl./9



FERGUSSON  
H162-17021  
21,5 cm



MAYO  
H162-17527  
27 cm



MAYO  
H162-17801 - H162-17803  
27 cm

H162-17801  
klein - small - petite  
pequeña - piccola

H162-17803  
gross - large - grande

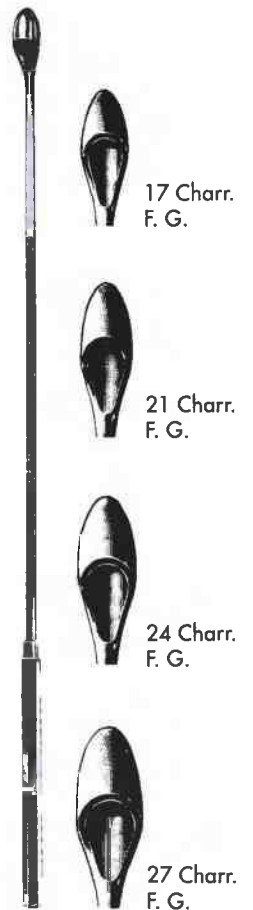

DESJARDINS  
H162-18017 - H162-18027

17 Charr.  
F. G.

21 Charr.  
F. G.

24 Charr.  
F. G.

27 Charr.  
F. G.



Niere  
Kidney  
Rein  
Riñon  
Rene

164



MAYO  
H162-21032  
32 cm

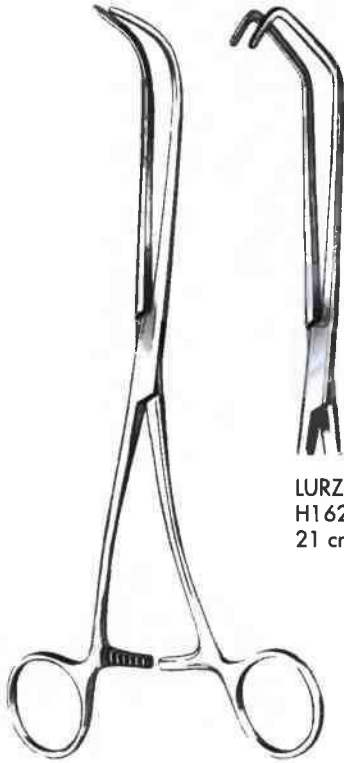

LURZ  
H162-22121  
21 cm

Ureterklemmen  
Ureter Clamps  
Pincés-clamps à uretère  
Pinzas clamps para ureter  
Pinze per uretere

LURZ  
H162-22321  
21 cm



RANDALL  
H162-23101 - H162-23106

Nierensteinzangen  
Kidney Stone Forceps  
Pincés à calculs renaux  
Pinzas para cálculos renales  
Pinze per calcoli renali

RANDALL	Fig.	cm
H162-23101	1	23
H162-23102	2	22
H162-23103	3	22
H162-23104	4	22
H162-23105	5	19
H162-23106	6	19

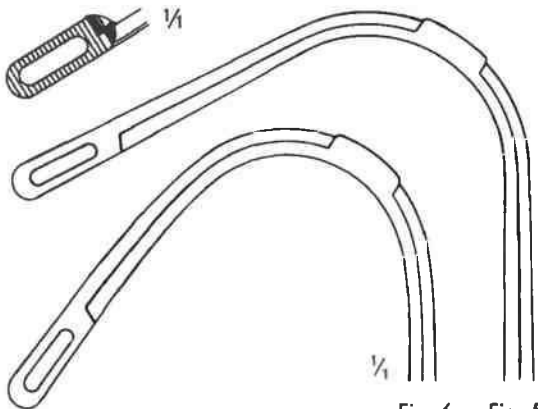

Fig. 6 Fig. 5

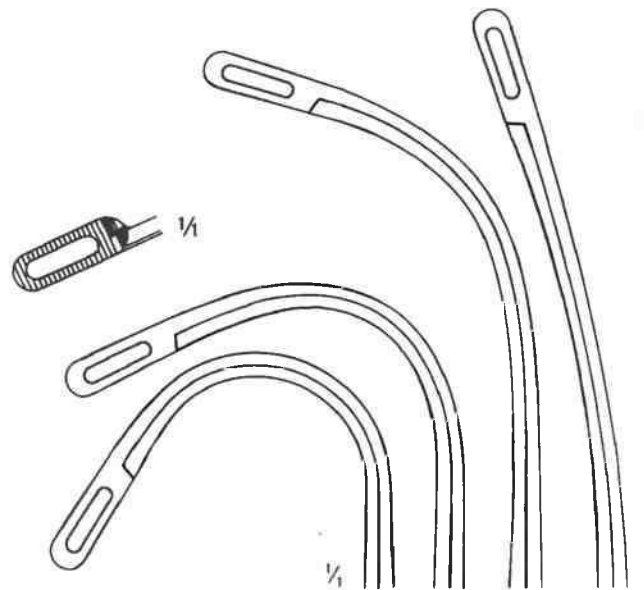
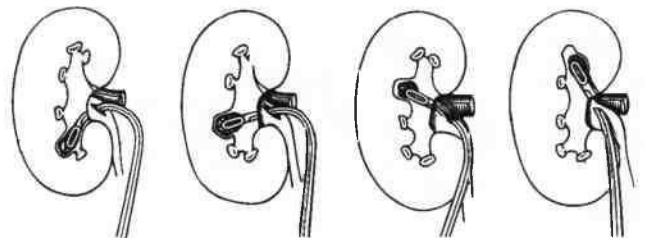

Fig. 4 Fig. 3 Fig. 2 Fig. 1

in situ:



5-6



4

3

2

1

Darm- und Gewebefäßzangen  
Bowel and Tissue Grasping Forceps  
Pinces à saisir les intestins et les tissus  
Pinzas para coger intestinos y tejidos  
Pinze per afferrare intestini e tessuti

Darm, Magen  
Intestines and Stomach  
Intestin, Estomac  
Intestines, Estómago  
Intestini, Stomaco

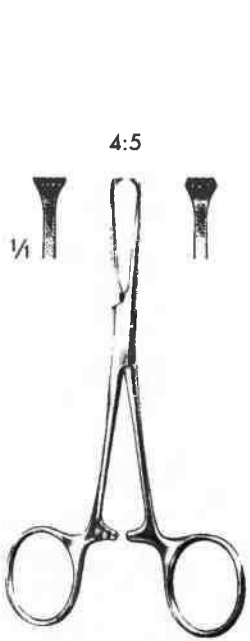

ALLIS-Baby  
H164-10214  
14 cm

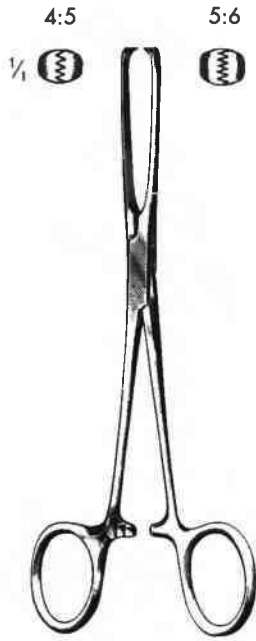

4:5	ALLIS	5:6
H164-11015	15 cm H164-12015	H164-12019
	19 cm H164-12022	
	22 cm H164-12024	



atraumatisch  
atraumatic  
atraumatique  
atraumática  
atraumatica

cm	ALLIS
16	H164-12416
20	H164-12420
25	H164-12425

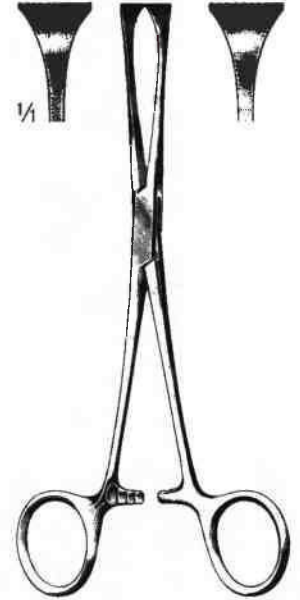

ALLIS-ADAIR  
H164-13015  
15,5 cm



cm	JUDD-ALLIS
15	H164-14015
19	H164-14019



THOMS-ALLIS  
H164-15020  
20 cm

Mit TC-Einsätzen  
TC Lined  
A mors TC  
Con bocas TC  
Con morso TC



atraumatisch  
atraumatic  
atraumatique  
atraumática  
atraumatica

cm	BABCOCK	TC
14	H164-16014	
16	H164-16016	H164-16416 H164-16816
18	H164-16018	
20	H164-16020	H164-16420 H164-16820
24	H164-16024	

Darm, Magen  
Intestines and Stomach  
Intestin, Estomac  
Intestines, Estómago  
Intestini, Stomaco

164

Mit TC-Einsätzen  
TC Lined  
A mors TC  
Con bocas TC  
Con morso TC



	DUVAL	DUVAL
	13 mm	25 mm
18	H164-17018	
20	H164-17020	H164-17220
20	H164-17420	
23		H164-17223

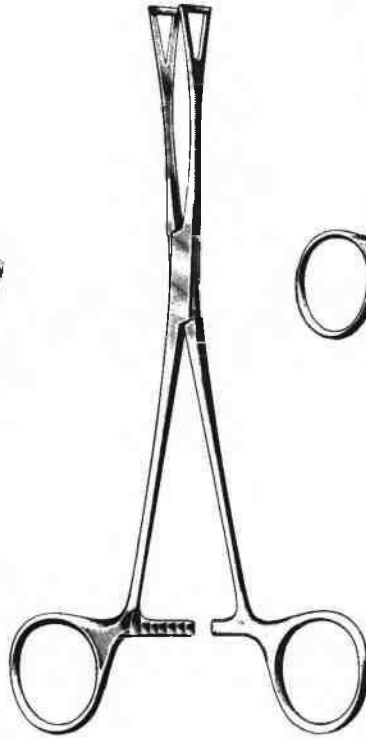

DUVAL  
H164-17018 - H164-17420



WILLIAMS  
H164-18016  
16,5 cm



SCHOENBURG  
H164-18222  
22 cm

Darmklemmen  
Intestinal Forceps  
Pinces intestinales  
Pinzas intestinales  
Pinze intestinali

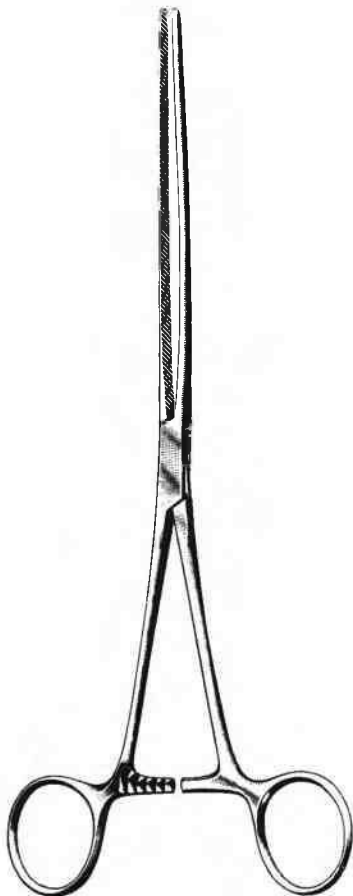

DOYEN  
DOYEN-Baby  
H164-21018 - H164-21723

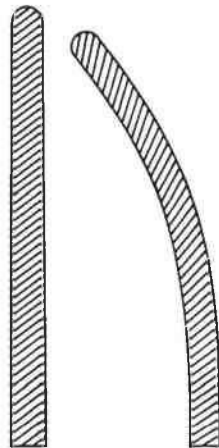

cm	DOYEN-Baby	
16		
18	H164-21018	H164-21118
21		
23		

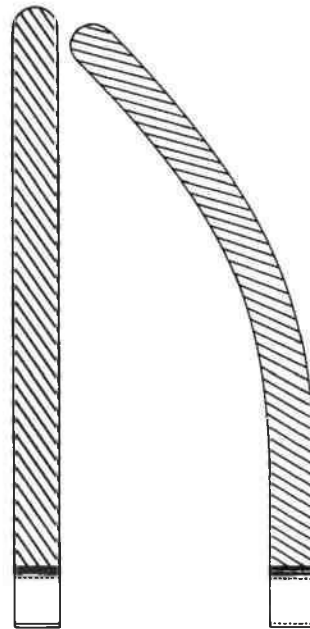

	DOYEN	

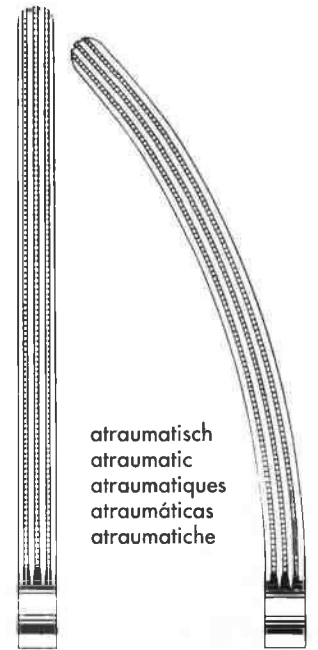

atraumatisch  
atraumatic  
atraumatiques  
atraumáticas  
atraumatiche

Darmklemmen  
Intestinal Forceps  
Pincas intestinales  
Pinzas intestinales  
Pinze intestinali



KOCHER  
H164-22022 - H164-22728

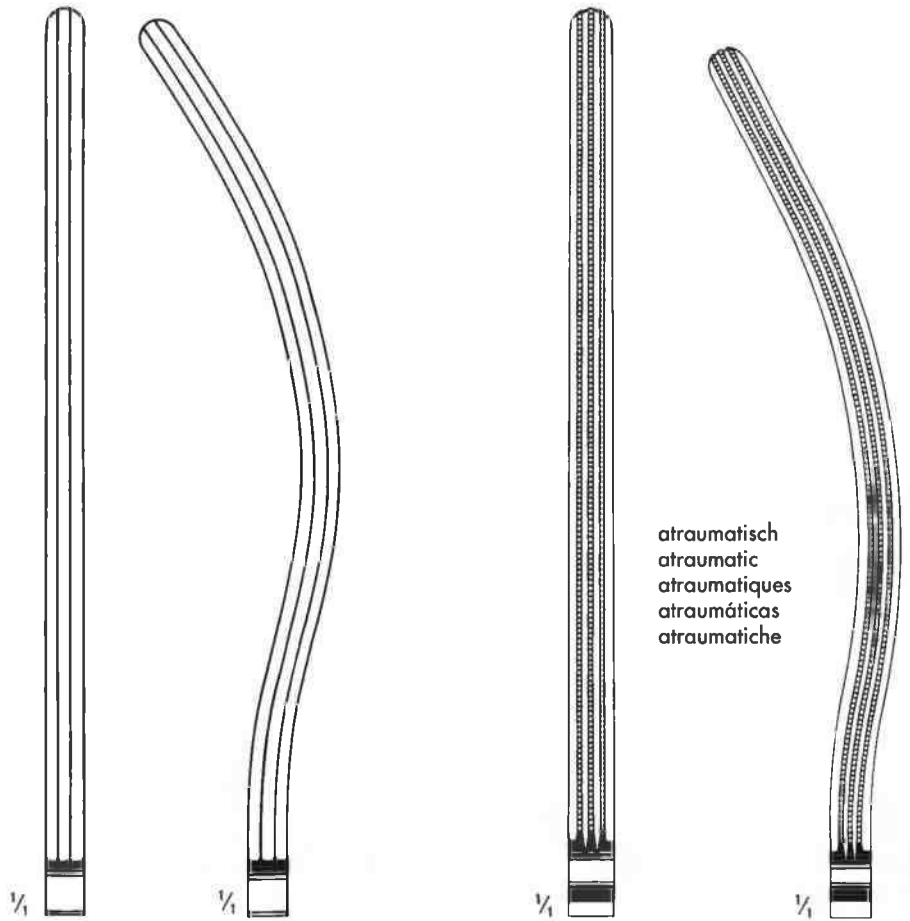

atraumatisch  
atraumatic  
atraumatiques  
atraumáticas  
atraumatice

cm	KOCHER			
22	H164-22022	H164-22122	H164-22622	H164-22722
25	H164-22025	H164-22125	H164-22625	H164-22725
28	H164-22028	H164-22128	H164-22628	H164-22728

Darm, Magen  
Intestines and Stomach  
Intestin, Estomac  
Intestines, Estómago  
Intestini, Stomaco

Darmklemmen  
Intestinal Forceps  
Pincas intestinales  
Pinzas intestinales  
Pinze intestinali

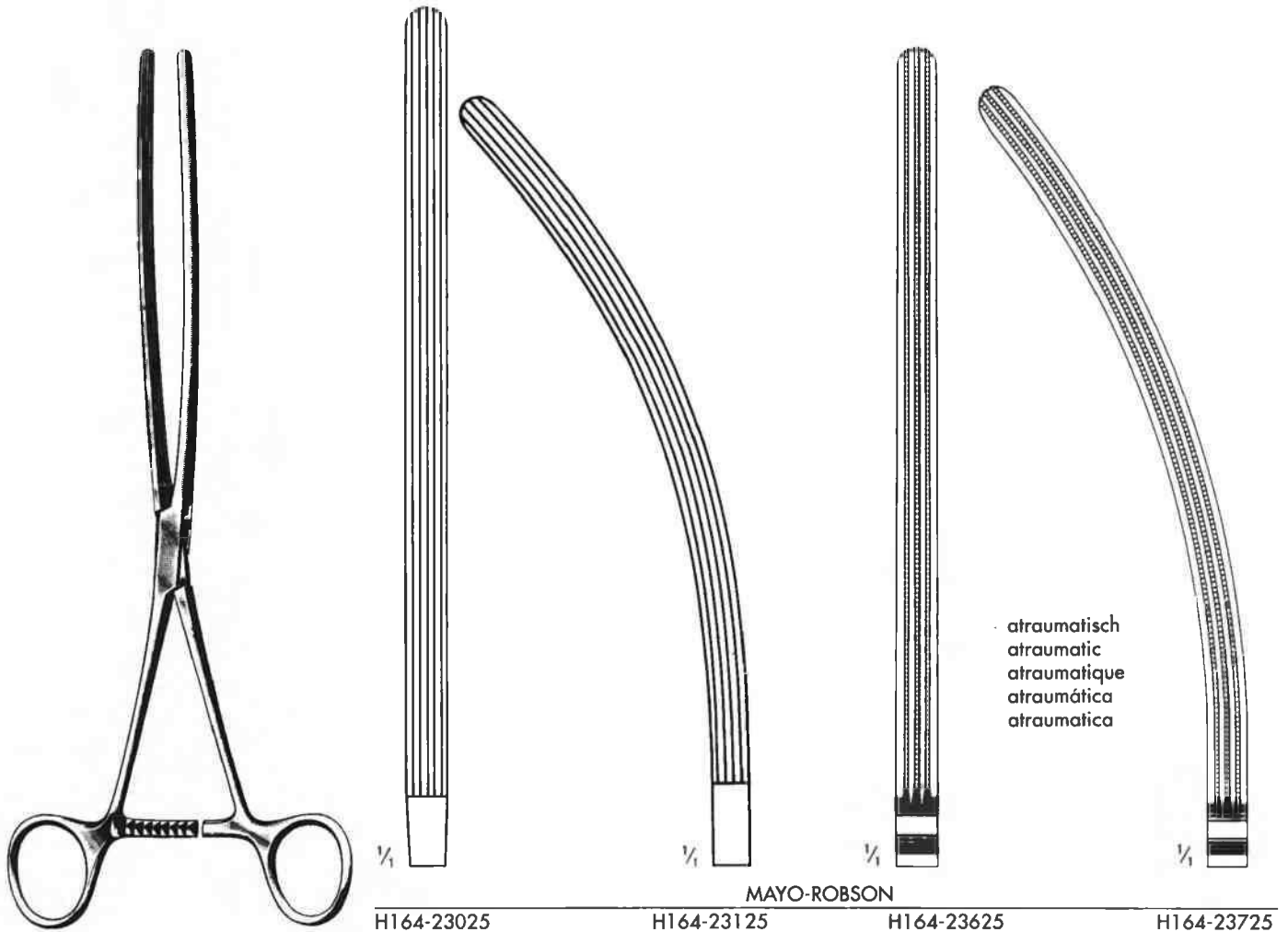

MAYO-ROBSON  
H164-23025 - H164-23725  
25 cm

H164-23025 H164-23125 H164-23625 H164-23725



Darm, Magen  
Intestines and Stomach  
Intestin, Estomac  
Intestines, Estómago  
Intestini, Stomaco

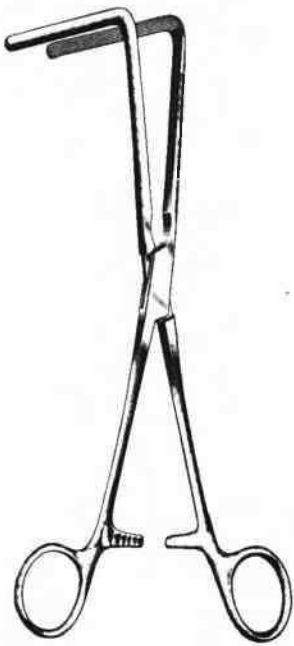

normal FEHLAND atraum.  
H164-24123 23,5 cm H164-24723

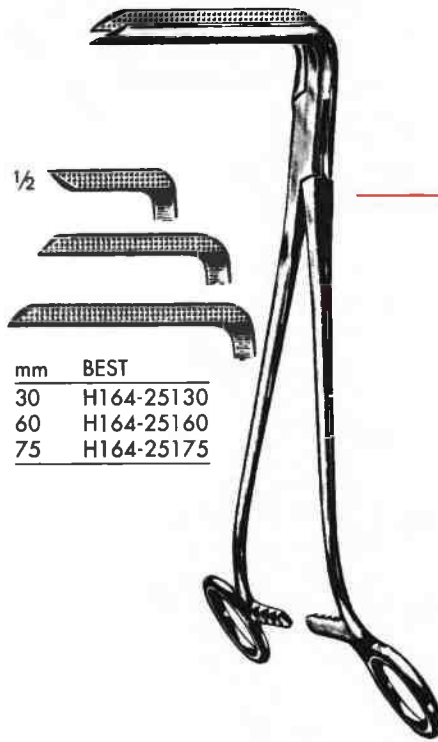

mm	BEST
30	H164-25130
60	H164-25160
75	H164-25175

BEST  
H164-25130 - H164-25175  
26,5 cm

Darm- und Magenklappen  
Intestinal and Stomach Clamps  
Pinces-clamps intestinales  
Pinzas-clamps intestinales y estomacales  
Pinze intestinali e stomacali



BRUNNER  
H164-26024 - H164-26624  
24 cm

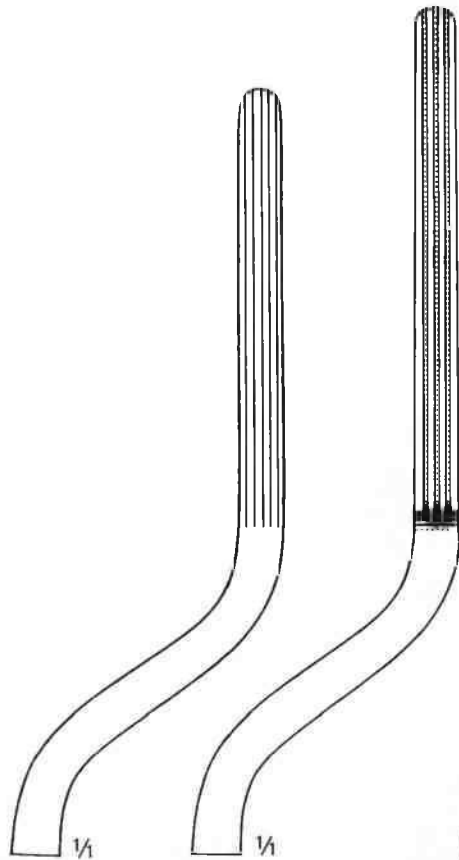

BRUNNER  
H164-26024 H164-26624

atraumatisch  
atraumatic  
atraumatique  
atraumática  
atraumatica

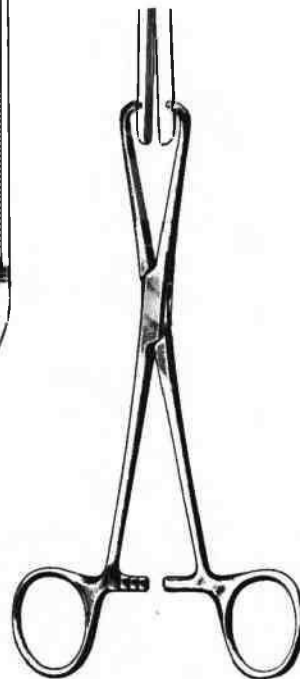

STONE  
H164-27015  
15,5 cm



STONE-WATT  
H164-27400



cm	STONE-WATT
7,5	H164-27207
10	H164-27210

Darm, Magen  
Intestines and Stomach  
Intestin, Estomac  
Intestines, Estómago  
Intestini, Stomaco

Anastomosenklemmen und Zubehör  
Anastomosis Clamps and Accessories  
Clamps à anastomose et accessoires  
Clamps para anastomosis y accesorios  
Pinze per anastomosi e accessori

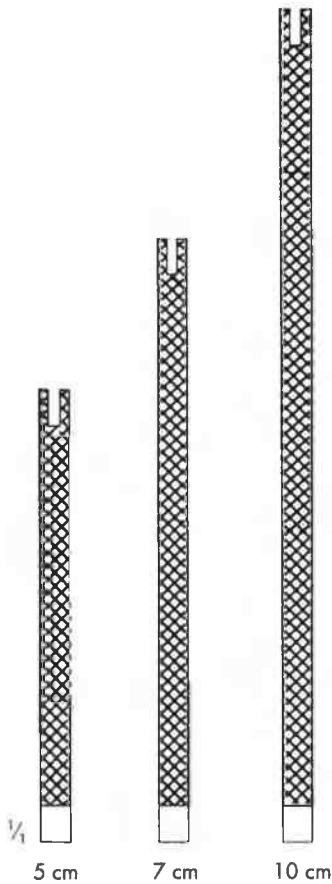

cm	DE MARTEL-WOLFSON
5	H164-28005
7	H164-28007
10	H164-28010
Set/3	

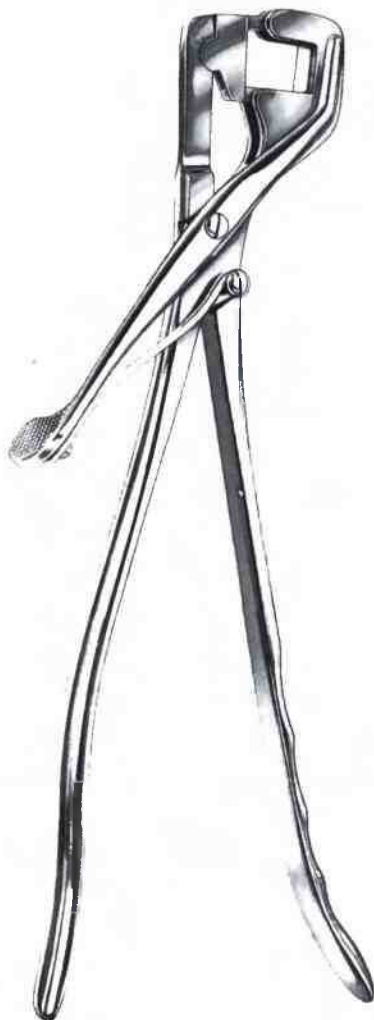

DE MARTEL-WOLFSON  
H164-28226  
26 cm

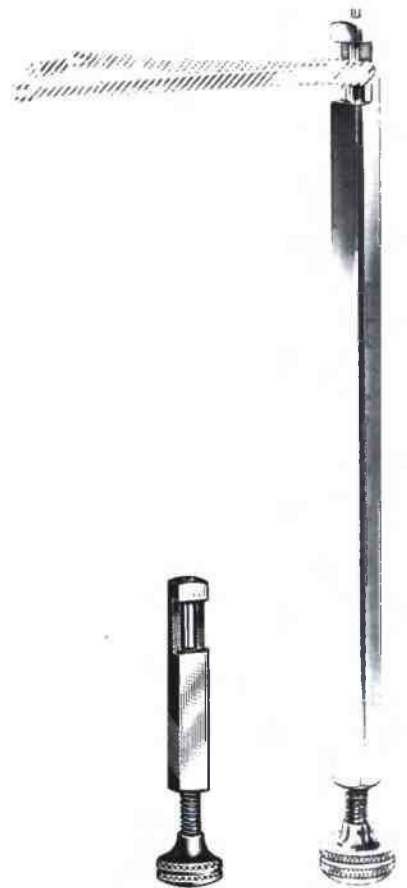

DE MARTEL-WOLFSON  
H164-28408 H164-28423  
8,5 cm 23 cm

Magenklemmen  
Stomach Clamps  
Pincas-clamps stomacales  
Pinzas-clamps estomacales  
Pinze stomacali

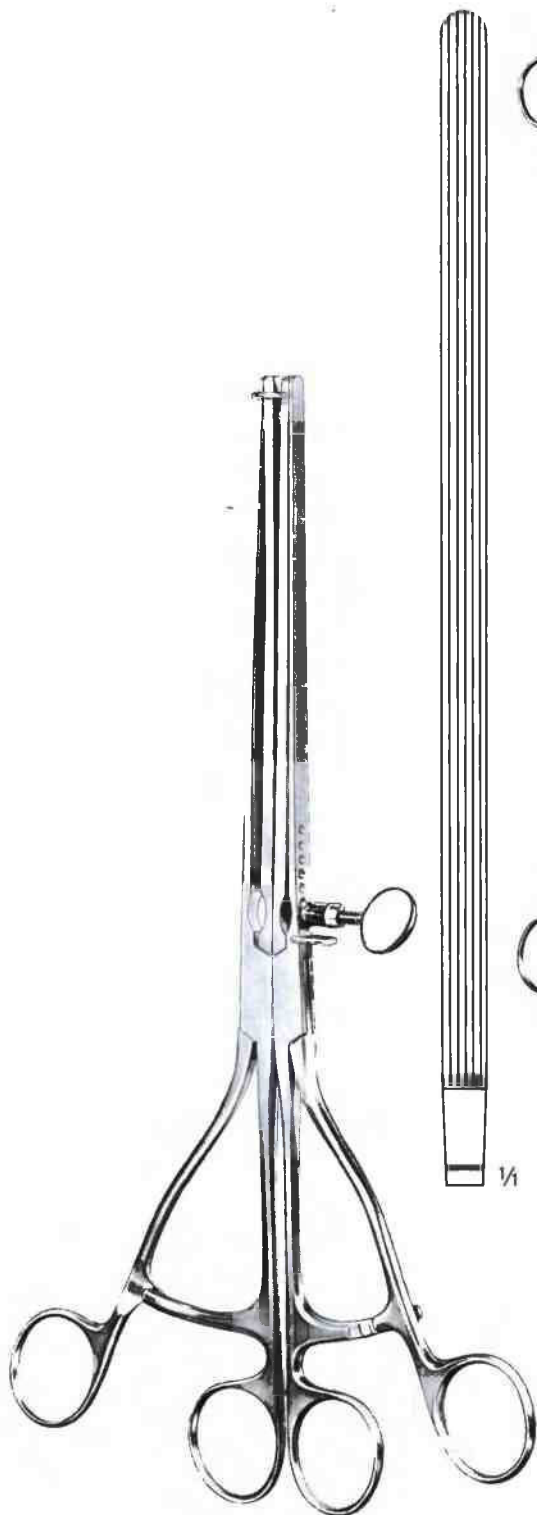

LANE  
H164-29030  
30 cm

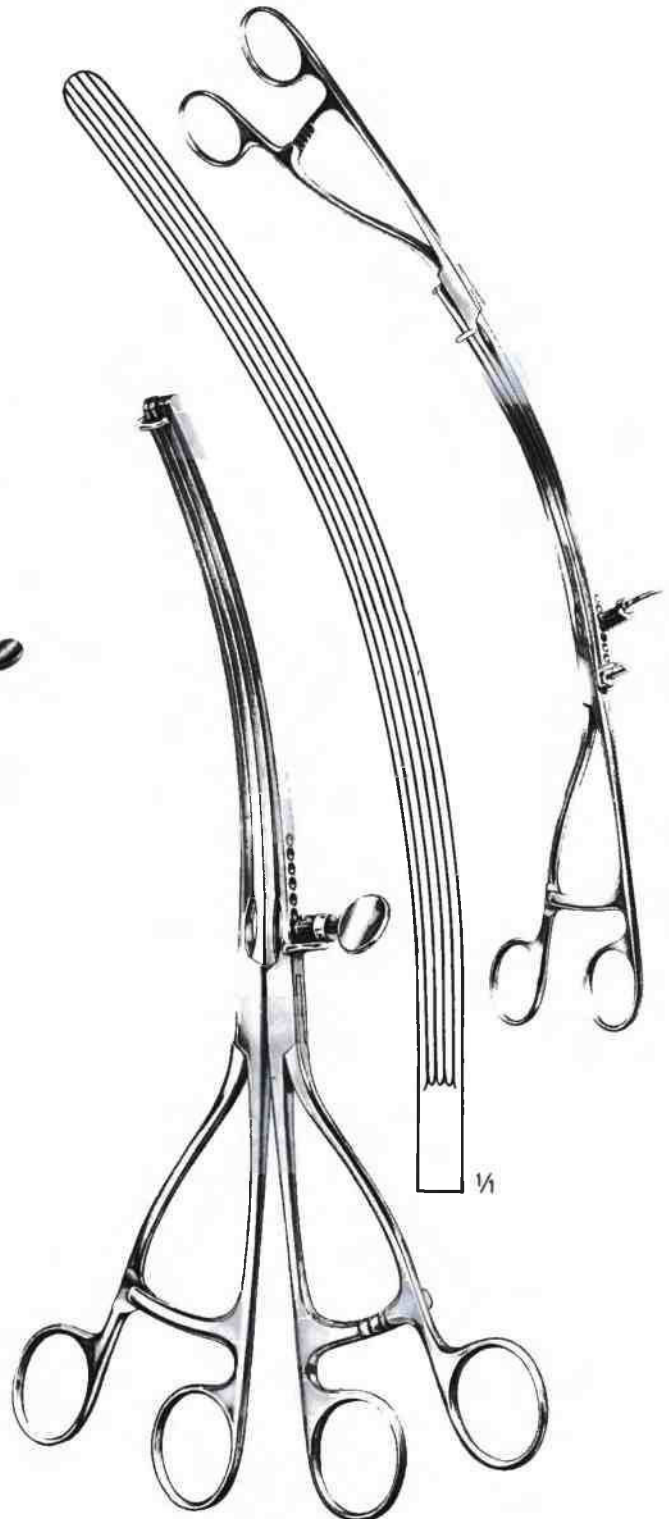

LANE  
H164-29130  
30 cm

Darm, Magen  
Intestines and Stomach  
Intestin, Estomac  
Intestines, Estómago  
Intestini, Stomaco

164

Magenklemmen  
Stomach Clamps  
Pincés-clamps stomacales  
Pinzas-clamps estomacales  
Pinze stomacali

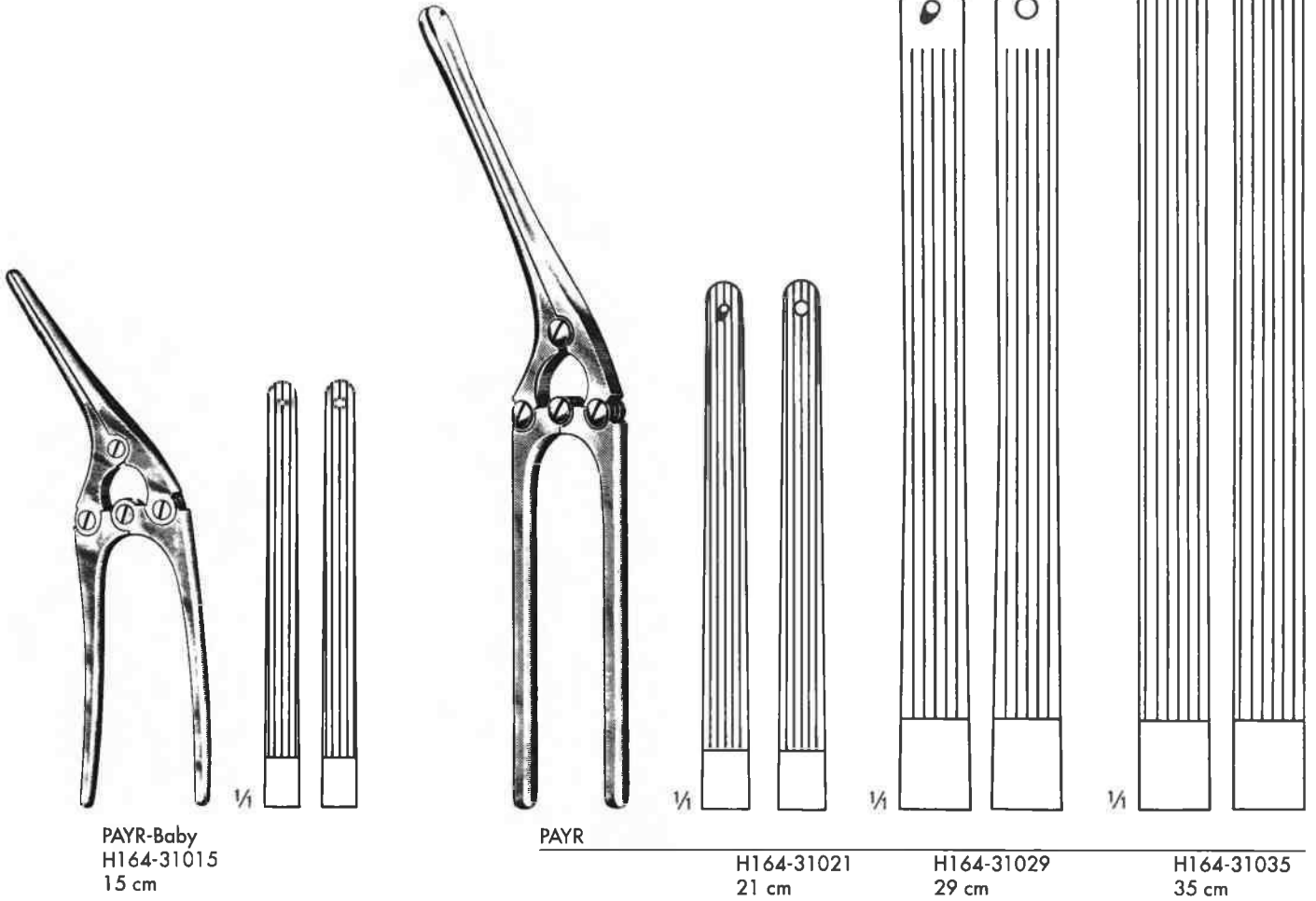

PAYR-Baby  
H164-31015  
15 cm

PAYR

H164-31021  
21 cm

H164-31029  
29 cm

H164-31035  
35 cm

Magen- und Darmnähapparat · Stomach and Intestinal Suturing Apparatus · Appareil à sutures stomacales et intestinales · Aparato para suturas estomacales e intestinales · Apparecchio per suture stomacali e intestinali

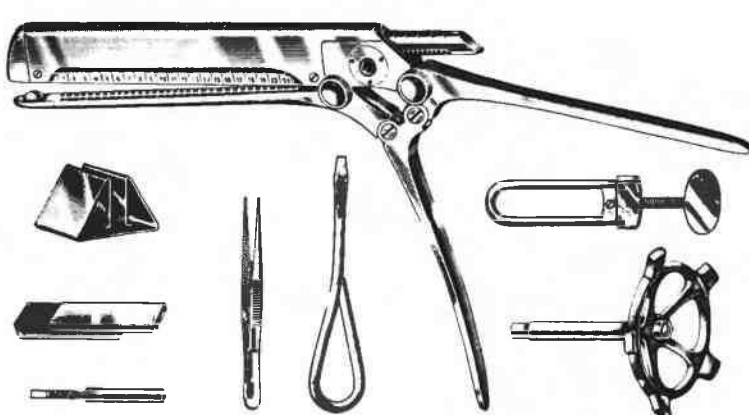

v. PETZ  
H164-32000  
compl.



300 Stück  
300 ea.  
300 pièces  
300 c/u  
300 pezzi

H164-32100

Prostata-Haken, -Faßzange  
Prostatic Retractors, Grasping Forceps  
Ecarteurs à prostate, Pince à saisir la prostate  
Separadores, Pinza para coger prostata  
Divaricatori, Pinza per afferrare la prostata

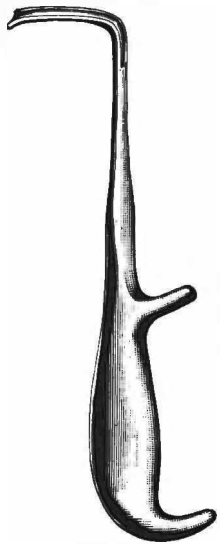

YOUNG  
H166-10121  
21 cm

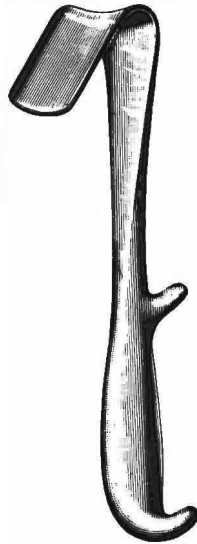

YOUNG  
H166-10322  
22 cm

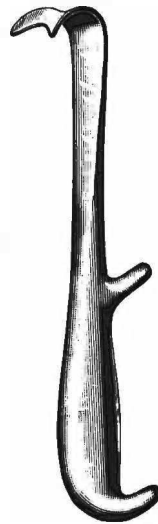

YOUNG  
H166-10521  
21 cm

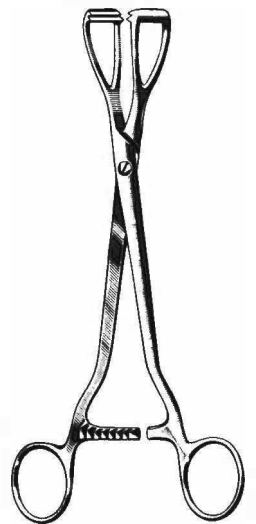

YOUNG  
H166-10620  
20 cm

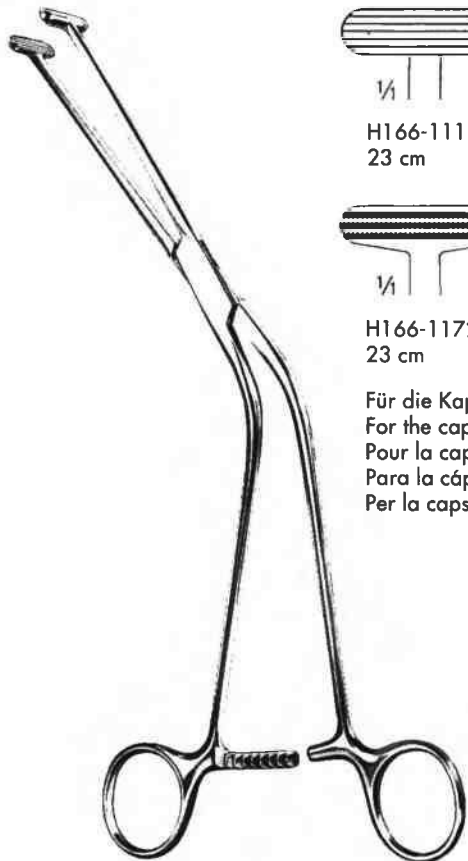

MILLIN  
H166-11123 - H166-12524

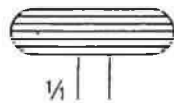

H166-11123  
23 cm

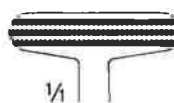

H166-11723  
23 cm

Für die Kapsel  
For the capsule  
Pour la capsule  
Para la cápsula  
Per la capsula

atraumatisch  
atraumatic  
atraumatique  
atraumática  
atraumatica

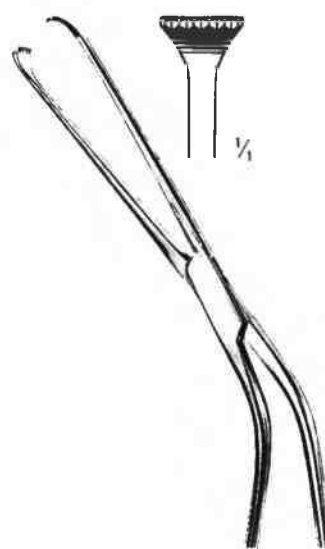

MILLIN  
H166-12323  
23 cm

Für die vord. Lappen  
Anterior Lobe  
Pour lobe antérieur  
Para lobo anterior  
Per lobo anteriore

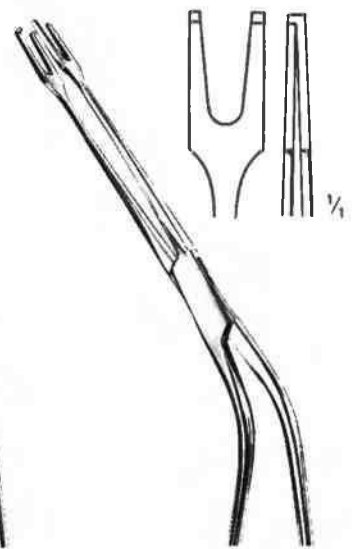

MILLIN  
H166-12524  
24 cm

Fadenführer  
Ligature Carrier  
Porte-ligature  
Porta-ligaduras  
Portafilo



Blasenspatel, -Wundsperrer  
Bladder Retractors, Spreaders  
Spatules, Ecarteurs vésicaux  
Espátulas, Separadores vesicales  
Spatole, Divaricatori vescicali



JUDD-MASSON  
H166-15000



LEGUEU  
H166-14727

KOCHER  
H166-14927



THOMSON-WALKER  
H166-16000



LEGUEU  
H166-16300



MILLIN  
H166-16500

Fremdkörperzangen  
Foreign Body Forceps  
Pinces à corps étrangers  
Pinzas para cuerpos extráneos  
Pinze per corpi estranei

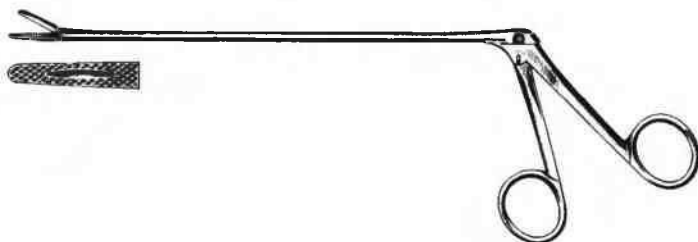

cm	MATHIEU
20	H166-16820
28	H166-16828

Urethrotom, Messer auswärts  
Urethrotome, cutting outward  
Urétrotome, tranchant extérieur  
Uretrótomo, cuchillos exteriores  
Uretrótomo, coltelli esteriori

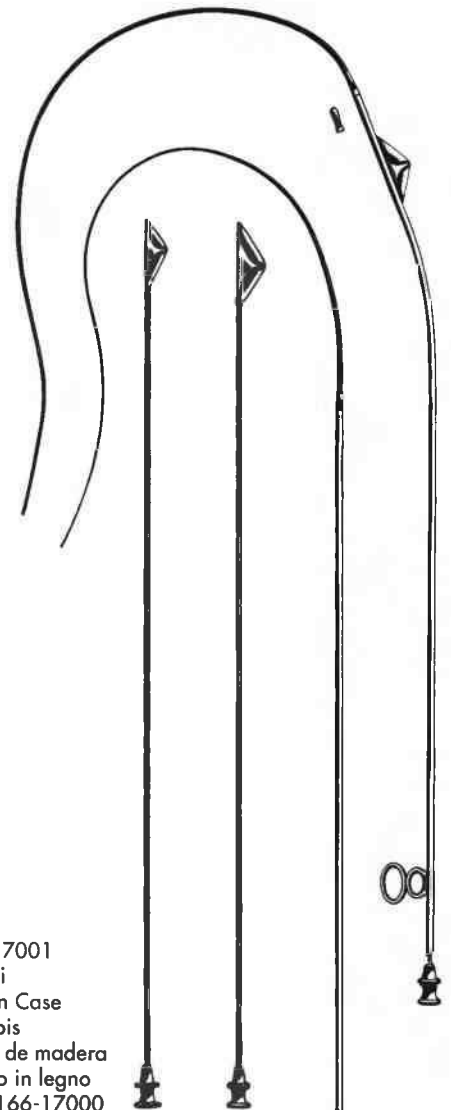

H166-17001  
Holzetui  
Wooden Case  
Bôte bois  
Estuche de madera  
Astuccio in legno  
f./p. H166-17000

MAISONNEUVE  
H166-17000  
compl.

Urologie  
Urology  
Urologie  
Urología  
Urologia

66

Sekretlöffel, Katheterspanner  
Secretions Scoops, Catheter Introducer  
Cuiller à sécrétions, Introducteur de sondes  
Cucharillas p. secreciones, Introducitor de catéteres  
Cucchiai per secrezioni, mandrini per sonde uretrali

Penisklemmen  
Meatus Clamps  
Compresseurs de l'urètre  
Compresores uretrales  
Serrapene



STOCKMANN  
H166-17508  
8 cm

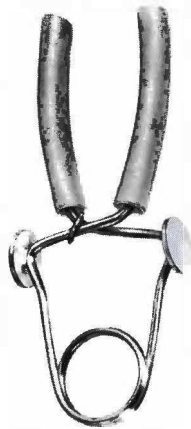

STRAUSS  
H166-17711  
11 cm



GUTMANN  
H166-18026

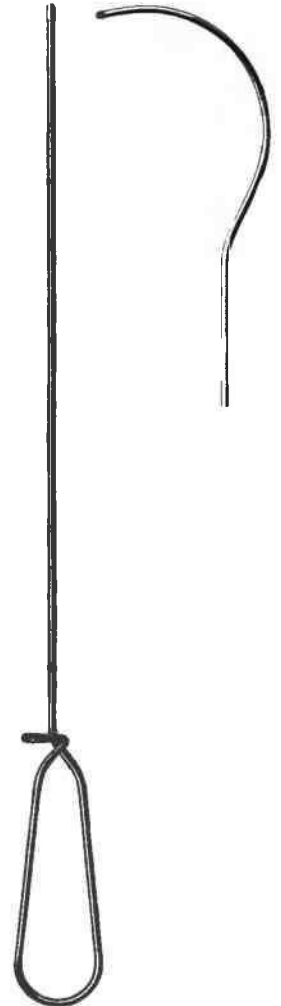

GUYON  
H166-18439 H166-18535  
39 cm 35 cm

Harnröhren-Dilatationsbesteck  
Urethral Dilation Set  
Jeu d'instruments pour la dilatation de l'urètre  
Juego de instrumentos para la dilatación de la uretra  
Set di strumenti per la dilatazione uretrale

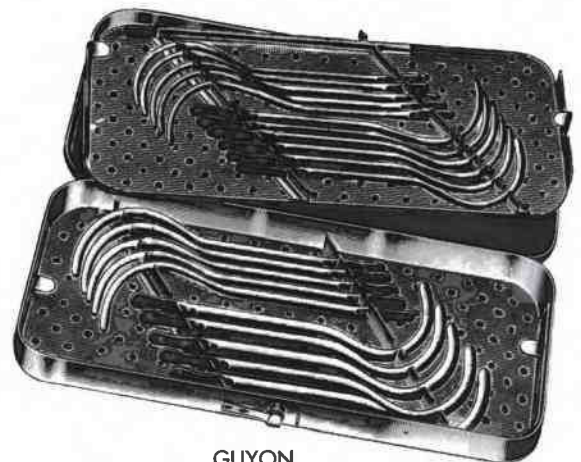

GUYON  
H166-20000  
compl.

Dilatations-Bougies, Metall-Katheter  
Dilating Bougies, Metal Catheters  
Bougies dilatatrices, Sondes métalliques  
Bujías dilatadoras, Sondas metálicas  
Candelette dilatatrici, Sonde metalliche

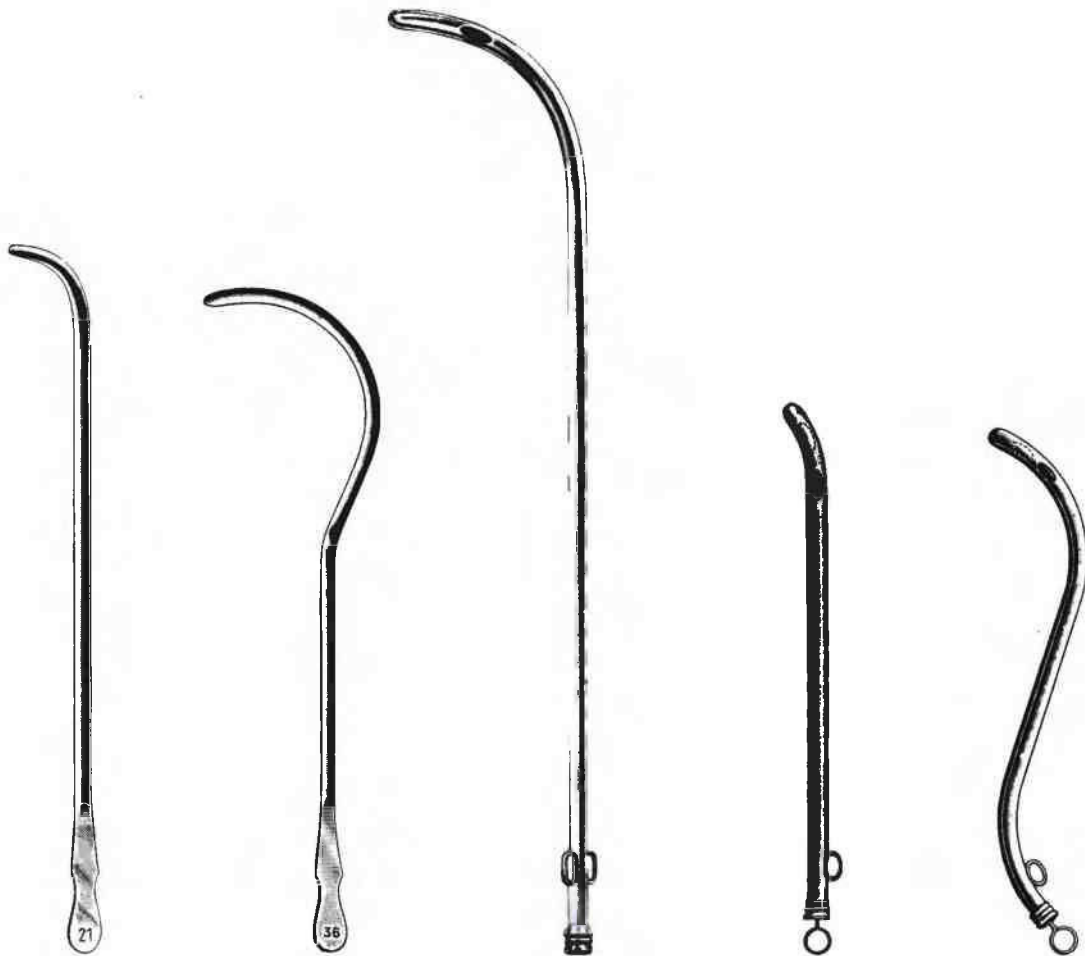

Charr./F.G.	van BUREN	GUYON*			COXETER
8	H166-20108	H166-20508	H166-21108	H166-21308	H166-21908
10	H166-20110	H166-20510	H166-21110	H166-21310	H166-21910
12	H166-20112	H166-20512	H166-21112	H166-21312	H166-21912
14	H166-20114	H166-20514	H166-21114	H166-21314	H166-21914
16	H166-20116	H166-20516	H166-21116	H166-21316	H166-21916
18	H166-20118	H166-20518	H166-21118	H166-21318	H166-21918
20	H166-20120	H166-20520	H166-21120	H166-21320	H166-21920
22	H166-20122	H166-20522	H166-21122	H166-21322	H166-21922
24	H166-20124	H166-20524	H166-21124	H166-21324	H166-21924
26	H166-20126	H166-20526			
28	H166-20128	H166-20528			
30	H166-20130	H166-20530			
32	H166-20132	H166-20532			
34	H166-20134	H166-20534			
36	H166-20136	H166-20536			
38		H166-20538			
40		H166-20540			

H166-20100  
Set compl.  
8 - 36

\*Zwischengrößen:  
Intermediate Sizes:  
Dimensions intermédiaires:  
Dimensiones intermediarias:  
Dimensioni intermediari:

Ch./F.G.	No.
9	H166-20509
11	H166-20511
-	-
-	-
39	H166-20539

Mastdarm  
Rectum  
Rectum  
Recto  
Retto

Mastdarm-Spekula  
Rectal Specula  
Spéculums rectaux  
Espéculos rectales  
Specoli rettali



CZERNY  
H168-10522  
22 cm



SIMS  
H168-11015  
15 cm



BODENHAMMER  
H168-11515  
H168-11715 = Kaltlicht · Cold Light  
15 cm  
Lumière froide  
Luz fría · Luce fredda

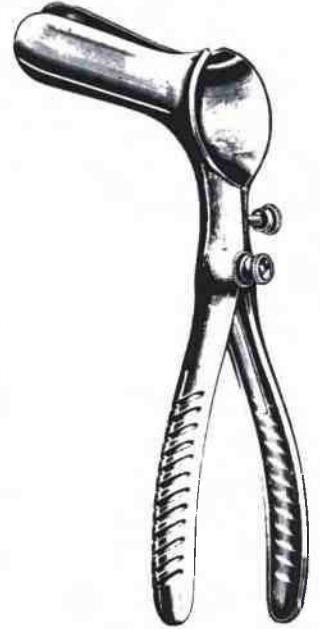

PRATT  
H168-12100



BARR  
H168-12517  
70 x 22 mm  
17 cm



MATHIEU  
H168-13019  
19,5 cm



Mastdarm-Spreizer  
Anal Retractors  
Dilatateurs p. anus et rectum  
Separadores rectales  
Dilatatori per l'ano e il retto

Mastdarm  
Rectum  
Rectum  
Recto  
Retto

168



ALAN-PARKS  
H168-14700  
compl.  
13,5 cm



SMITH-BUIE  
H168-15015  
75 x 23 mm  
15 cm

H168-14800  
Kaltlicht-Adapter für H168-14700  
Cold Light Attachment for H168-14700  
Adaptateur lumière froide pour H168-14700  
Adaptador luz fría para H168-14700  
Adattatore luce fredda per H168-14700

Rektoskop  
Rectoscope  
Rectoscope  
Rectoscopia  
Rettoscopio



STRAUSS  
H168-16100 = Kaltlicht · Cold Light  
Lumière froide  
Luz fría · Luce fredda

Mastdarm  
Rectum  
Rectum  
Recto  
Retto

168

Anoskope, Proktoskope  
Anoscopes, Proctoscopes  
Anuscopes, Proctoscopes  
Anoscopios, Proctoscopios  
Anoscopi, Protoscopi



IVES-FANSLER  
H168-21022  
22 mm Ø  
L = 80 mm



Ø mm	HIRSCHMANN
16	H168-21216
19	H168-21219
22	H168-21222

L = 65 mm



mm		KELLY
22 x 50		H168-22005
22 x 100		H168-22010
22 x 140		H168-22014
22 x 200		H168-22020



Ø mm	KELLY
21	H168-22421
27	H168-22427

L = 50 mm

Cystikus-Haken  
Cystic Hooks  
Ecarteurs rectaux  
Ganchos rectales  
Uncini rettali



H168-25101  
Fig. 1

H168-25102  
Fig. 2

H168-25103  
Fig. 3

PRATT  
H168-25101 - H168-25103

Mastdarm  
Rectum  
Rectum  
Recto  
Retto



BUJE  
H168-26141  
41 cm



WESTON  
H168-26330  
30 cm

Biopsie-Zangen  
Biopsy Specimen Forceps  
Pinces emporte-pièce à biopsie  
Pinzas sacabocado para biopsia  
Pinze per biopsia

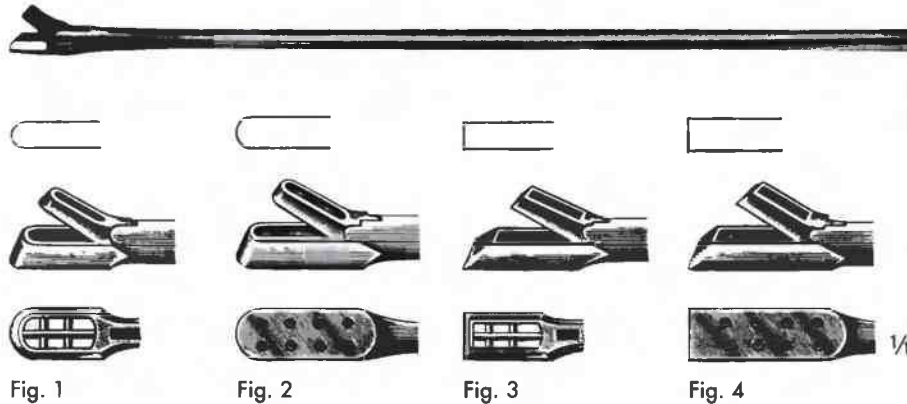
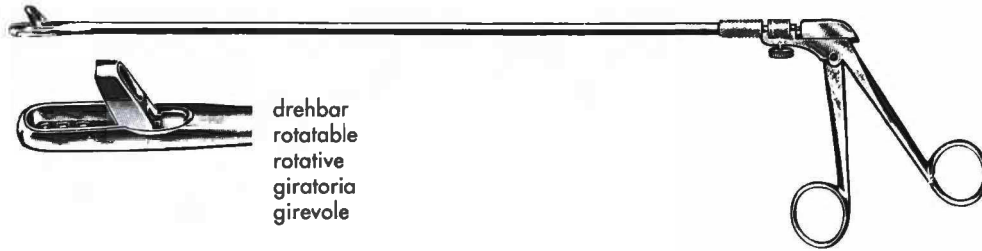
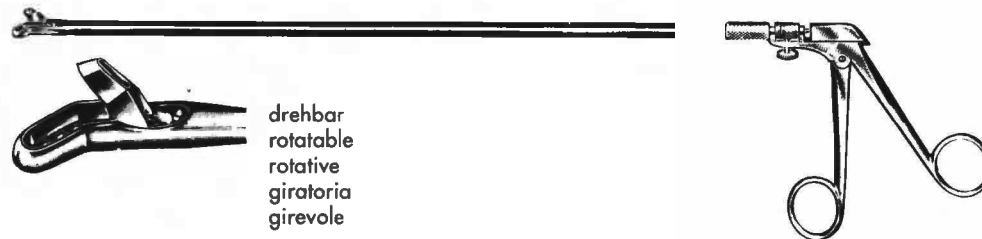

Fig. 1 Fig. 2 Fig. 3 Fig. 4

				cm	YEOMAN
H168-30128	H168-30228	H168-30328	H168-30428	28	
H168-30135	H168-30235	H168-30335	H168-30435	35	
H168-30142	H168-30242	H168-30342	H168-30442	42	



drehbar  
rotatable  
rotative  
giratoria  
girevole



drehbar  
rotatable  
rotative  
giratoria  
girevole

cm	TURREL
23	H168-32123
33	H168-32133
40	H168-32140

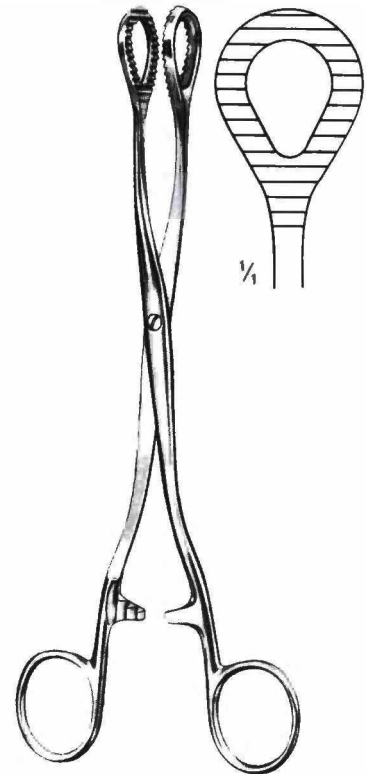

HEYWOOD-SMITH  
H168-40221  
21 cm

Gynäkologie  
Gynecology  
Gynécologie  
Ginecología  
Ginecologia



GRAVE

Fig.	mm	Standard	Laser Mod.
1	75 x 20	H170-11001	
2	95 x 35	H170-11002	H170-11402
3	115 x 35	H170-11003	H170-11403

Scheiden-Spekula  
Vaginal Specula  
Spéculums vaginaux  
Especulos vaginales  
Specoli vaginali



Fig.	mm	PEDERSON
1	75 x 13	H170-12001
2	100 x 22	H170-12002
3	120 x 25	H170-12003

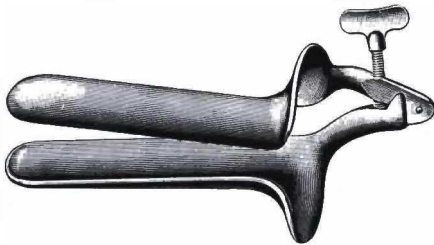
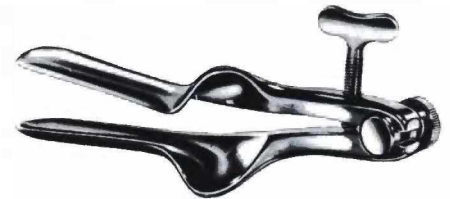

Fig.	mm	COLLIN
1	85 x 30	H170-13001
2	100 x 35	H170-13002
3	110 x 40	H170-13003



COLLIN  
H170-13100  
65 x 20 mm



COLLIN  
H170-13200  
65 x 10 mm



Fig.	mm	Standard	Laser Mod.
1	75 x 32	H170-14001	
2	85 x 35	H170-14002	H170-14402
3	100 x 35	H170-14003	H170-14403

ube  
ew  
ral  
e



Sen-Spekula  
al Specula  
lums vaginaux  
ulos vaginales  
li vaginali



Schweizer Modell  
Pattern  
e suisse  
o suizo  
lo svizzero



Mittelschraube  
Central Screw

Fig.	mm	CUSCO
1	90 x 23-25	H170-16001
2	100 x 25-27	H170-16002
3	110 x 27-30	H170-16003

Fig.	mm	CUSCO
1	75 x 32	H170-15001
2	85 x 36	H170-15002
3	95 x 37	H170-15003

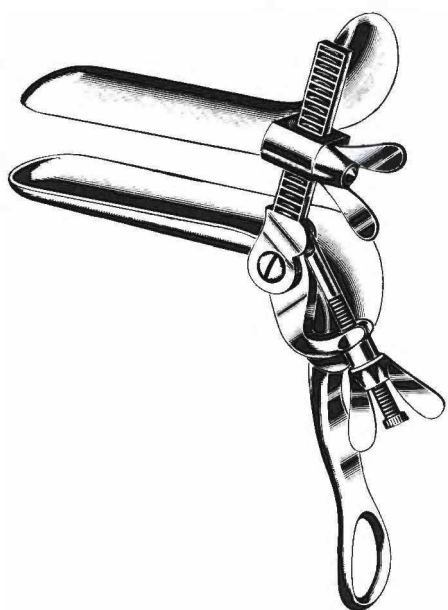

mm	TRELAT
85 x 33	H170-18001
95 x 35	H170-18002
115 x 43	H170-18003

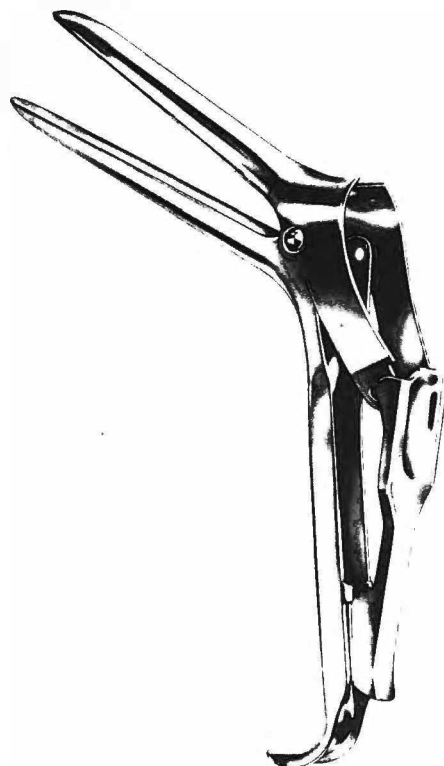

mm	SEMM
100 x 17-20	H170-19001
100 x 25-30	H170-19002



Gynäkologie  
Gynecology  
Gynécologie  
Ginecología  
Ginecologia

170

Scheiden-Spekula  
Vaginal Specula  
Spéculums vaginaux  
Espéculos vaginales  
Specoli vaginali

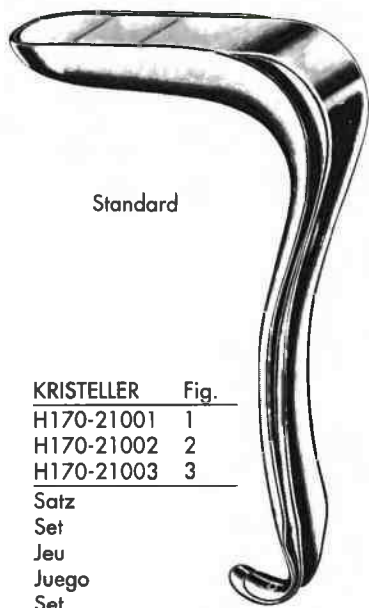

KRISTELLER	Fig.
H170-21001	1
H170-21002	2
H170-21003	3

Satz  
Set  
Jeu  
Juego  
Set

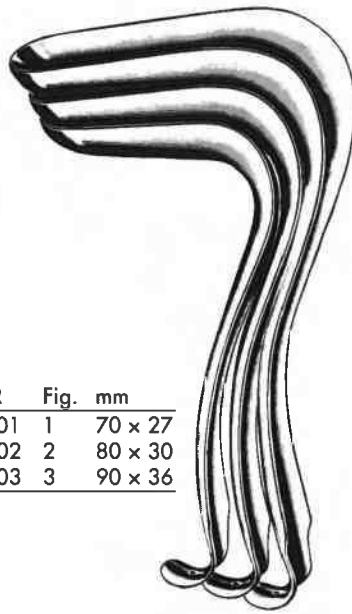

KRISTELLER	Fig.	mm
H170-21101	1	70 x 27
H170-21102	2	80 x 30
H170-21103	3	90 x 36

Spekulum  
Speculum  
Spéculum  
Espéculo  
Specolo

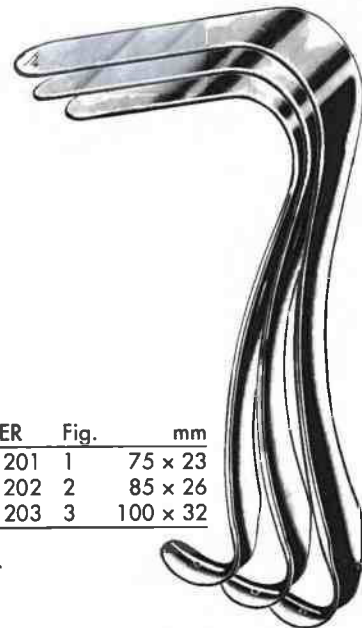

KRISTELLER	Fig.	mm
H170-21201	1	75 x 23
H170-21202	2	85 x 26
H170-21203	3	100 x 32

Halter  
Retractor  
Valve  
Valva

Mit konischen Blättern, für Jungfrauen  
With taper blades, for virgins  
A valves coniques, pour vierges  
Con hojas cónicas, para vírgenes  
Con valve coniche, per vergini

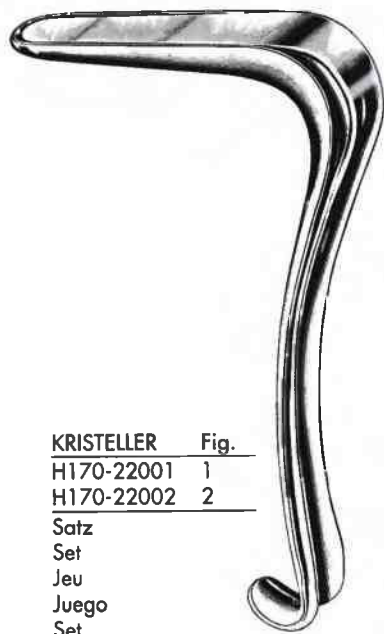

KRISTELLER	Fig.
H170-22001	1
H170-22002	2

Satz  
Set  
Jeu  
Juego  
Set

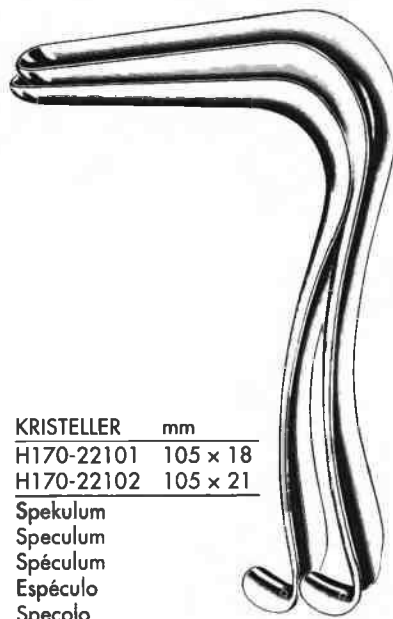

KRISTELLER	mm
H170-22101	105 x 18
H170-22102	105 x 21

Spekulum  
Speculum  
Spéculum  
Espéculo  
Specolo

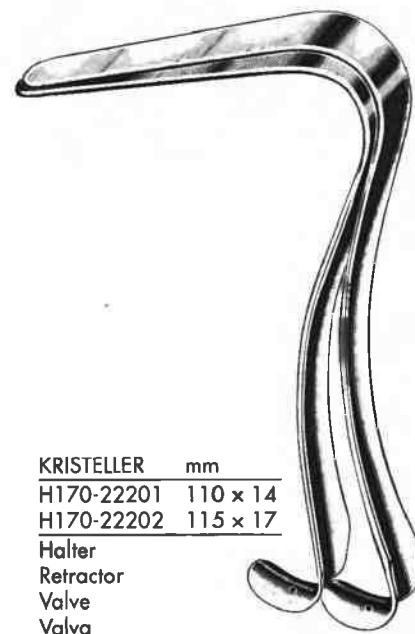

KRISTELLER	mm
H170-22201	110 x 14
H170-22202	115 x 17

Halter  
Retractor  
Valve  
Valva



Flache Spekula  
Specula Flat Hollow  
Spéculums plats  
Espéculos con huecos planos  
Specoli piatti

KRISTELLER	Fig.
H170-23001	1
H170-23002	2
H170-23003	3

Satz  
Set  
Jeu  
Juego  
Set

KRISTELLER	Fig.	mm
H170-23101	1	105 x 26
H170-23102	2	105 x 28
H170-23103	3	105 x 33

Spekulum  
Speculum  
Spéculum  
Espéculo  
Specolo

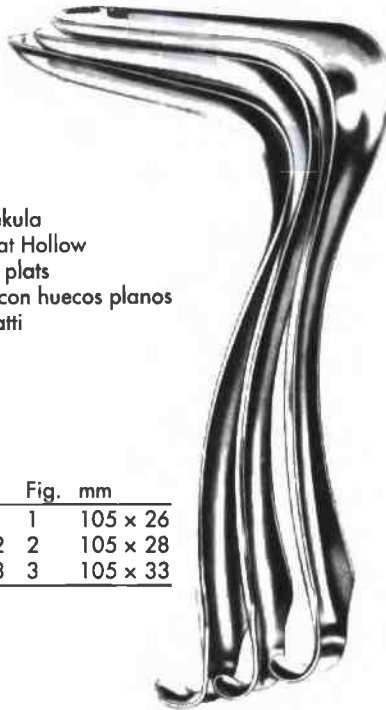

KRISTELLER	Fig.	mm
H170-23201	1	115 x 22
H170-23202	2	115 x 24
H170-23203	3	115 x 29

Halter  
Retractor  
Valve  
Valva

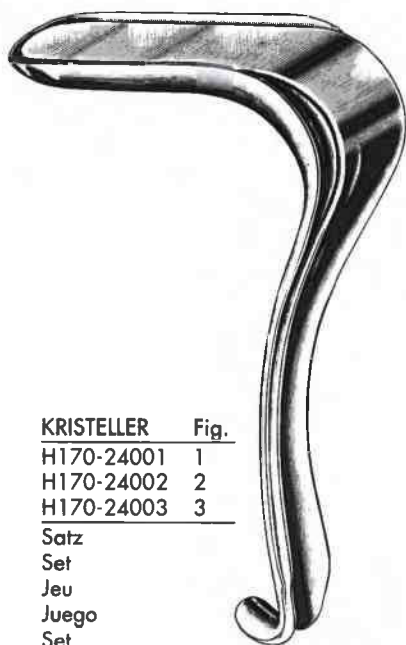

Tiefe Spekula  
Specula Deep Hollow  
Spéculums profonds  
Espéculos con huecos profundos  
Specoli profondi

KRISTELLER	Fig.
H170-24001	1
H170-24002	2
H170-24003	3

Satz  
Set  
Jeu  
Juego  
Set

KRISTELLER	Fig.	mm
H170-24101	1	110 x 27
H170-24102	2	110 x 30
H170-24103	3	110 x 36

Spekulum  
Speculum  
Spéculum  
Espéculo  
Specolo

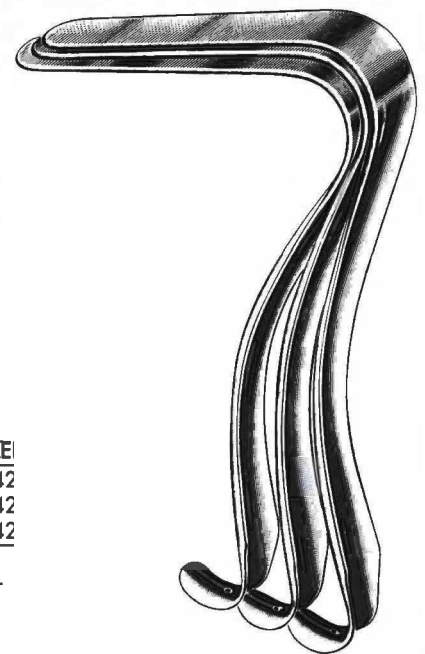
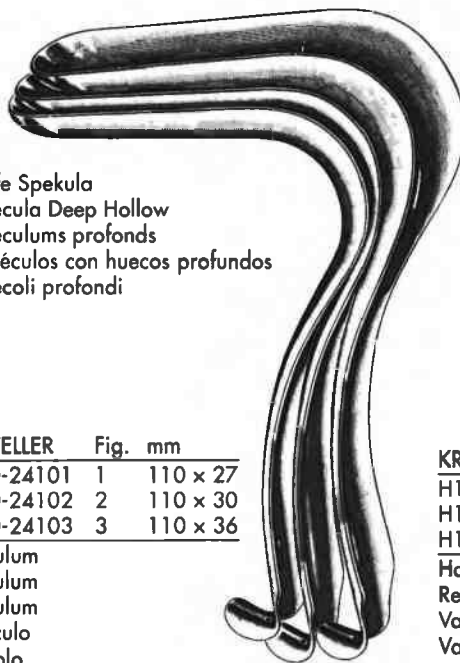

KRISTELLE
H170-242
H170-242
H170-242

Halter  
Retractor  
Valve  
Valva

Gynäkologie  
Gynecology  
Gynécologie  
Ginecología  
Ginecologia

Scheiden-Spekula  
Vaginal Specula  
Spéculums vaginaux  
Espéculos vaginales  
Specoli vaginali

170



KRISTELLER  
H170-25000  
Set



KALLMORGEN  
H170-26001 - H170-26202

KALLMORGEN	Fig.	Set	Spekulum Speculum Spéculum Espéculo Specolo	mm	Halte Retra Valve Valvc
	1	H170-26001	H170-26101	70 x 40	H170
	2	H170-26002	H170-26102	90 x 40	H170

Scheiden-Spekula  
Vaginal Specula  
Spéculums vaginaux  
Espéculos vaginales  
Specoli vaginali

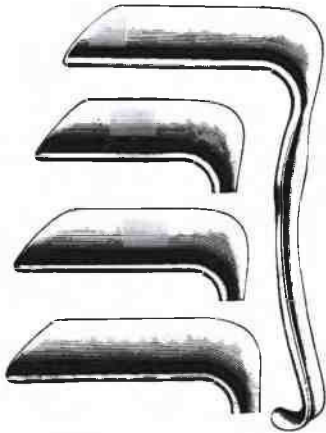

JACKSON	Fig.	mm
H170-27101	1	75 x 38
H170-27102	2	90 x 38
H170-27103	3	100 x 38

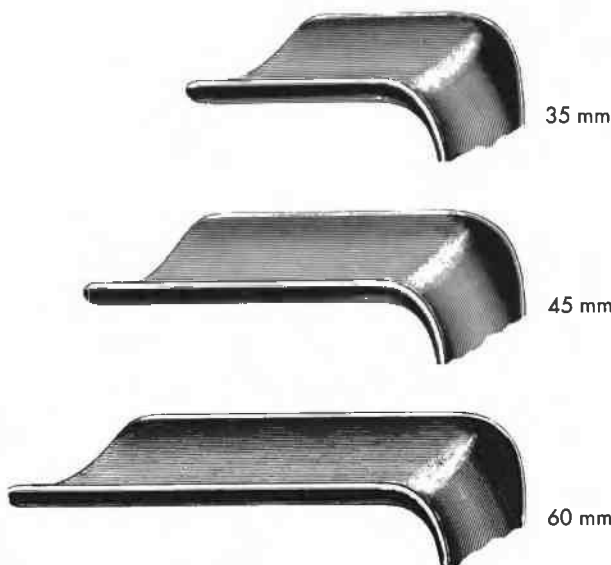

Fig. 1 = klein · small · petit  
pequeño · piccolo  
Fig. 2 = mittel · medium · moyen  
mediano · medio  
Fig. 3 = groß · large · grand  
grande

SIMS	Fig.
H170-28101	1
H170-28102	2
H170-28103	3



SIMS	Fig.
H170-29101	1
H170-29102	2
H170-29103	3
H170-29100 = Set	



DOYEN	Fig.	mm
H170-30101	1	55 x 35
H170-30102	2	85 x 35
H170-30103	3	115 x 35
H170-30301	1	55 x 45
H170-30302	2	85 x 45
H170-30303	3	115 x 45
H170-30304	4	160 x 45
H170-30501	1	55 x 60
H170-30502	2	85 x 60
H170-30503	3	115 x 60
H170-30504	4	160 x 60

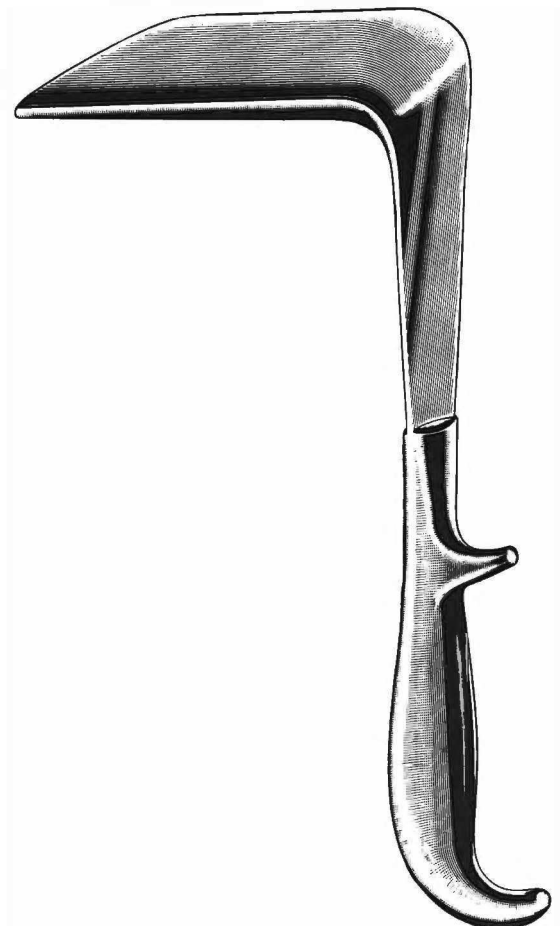

DOYEN  
H170-30101 - H170-30504



Gynäkologie  
Gynecology  
Gynécologie  
Ginecología  
Ginecologia

170

Scheiden-Spekula  
Vaginal Specula  
Spéculum vaginaux  
Especulos vaginales  
Specoli vaginali



Loses Gewicht  
Detachable Weight  
Poids démontable  
Pesa desmontable  
Peso smantabile  
H170-30700

**AUVARD**

Festes Gewicht  
Fixed Weight  
Poids fixe  
Pesa fija  
Peso fissa  
H170-30900



mm	BREISKY
100 x 20	H170-31020
100 x 25	H170-31025
100 x 30	H170-31030
100 x 35	H170-31035
100 x 40	H170-31040
130 x 20	H170-31320
130 x 25	H170-31325
130 x 30	H170-31330
130 x 35	H170-31335
130 x 40	H170-31340
155 x 40	H170-31540

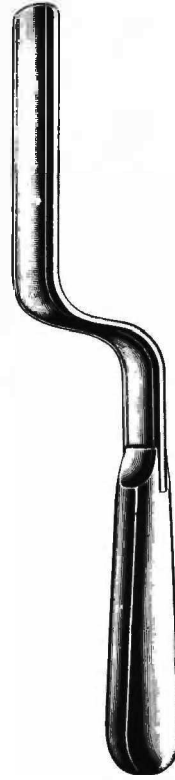

mm	LANDAU
100 x 28	H170-31928
100 x 38	H170-31938



**FRIEDMANN**  
H170-35110  
10 cm

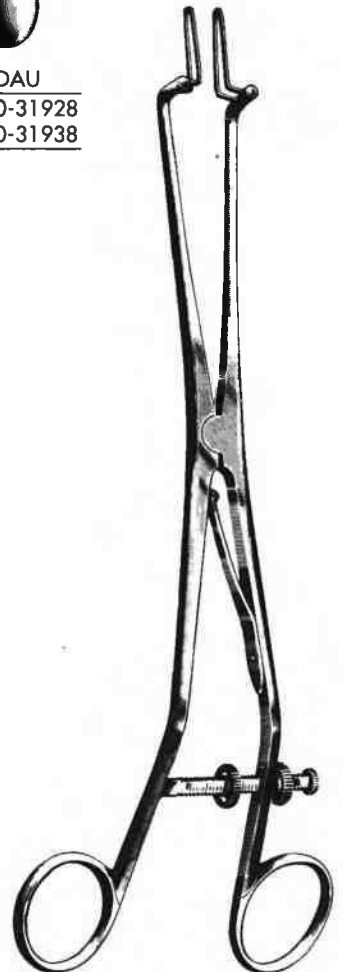

Standard	KOGAN	Laser
H170-36024	24 cm	H170-36424



Uterus-Dilatatoren  
Uterine Dilators  
Dilatateurs utérins  
Dilatadores uterinos  
Dilatatori uterini



HEGAR  
H170-40514  
4 - 17 mm  
14 Stück/ea./pces./c./u./pezzi

mm	HEGAR		mm
1	H170-41001	H170-41501	1,5
2	H170-41002	H170-41502	2,5
3	H170-41003	H170-41503	3,5
4	H170-41004	H170-41504	4,5
5	H170-41005	H170-41505	5,5
6	H170-41006	H170-41506	6,5
7	H170-41007	H170-41507	7,5
8	H170-41008	H170-41508	8,5
9	H170-41009	H170-41509	9,5
10	H170-41010	H170-41510	10,5
11	H170-41011	H170-41511	11,5
12	H170-41012	H170-41512	12,5
13	H170-41013	H170-41513	13,5
14	H170-41014	H170-41514	14,5
15	H170-41015	H170-41515	15,5
16	H170-41016	H170-41516	16,5
17	H170-41017		
18	H170-41018		
19	H170-41019		
20	H170-41020		
21	H170-41021		
22	H170-41022		
23	H170-41023		
24	H170-41024		
25	H170-41025		
26	H170-41026		
27	H170-41027		
28	H170-41028		
29	H170-41029		
30	H170-41030		



mm HEGAR  
4 - 17 H170-40614 14 Stück/ea./pces./c./u./pezzi  
1 - 26 H170-40626 26 Stück/ea./pces./c./u./pezzi

H170-40414 Satz/Set/Jeu/Juego  
H170-41004 - H170-41017 = 14

H170-40426 Satz/Set/Jeu/Juego  
H170-41001 - H170-41026 = 26

Uterus-Dilatatoren  
Uterine Dilators  
Dilatateurs utérins  
Dilatadores uterinos  
Dilatatori uterini

170

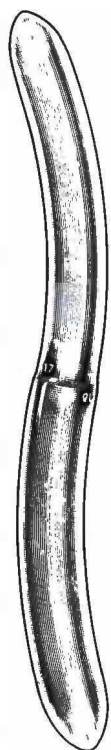

mm	HEGAR
1/2	H170-42001
3/4	H170-42003
5/6	H170-42005
7/8	H170-42007
9/10	H170-42009
11/12	H170-42011
13/14	H170-42013
15/16	H170-42015
17/18	H170-42017
19/20	H170-42019
21/22	H170-42021
23/24	H170-42023
25/26	H170-42025

H170-42408 Satz/Set/Jeu/Juego  
H170-42003 - H170-42017 = 8

H170-42413 Satz/Set/Jeu/Juego  
H170-42001 - H170-42025 = 13

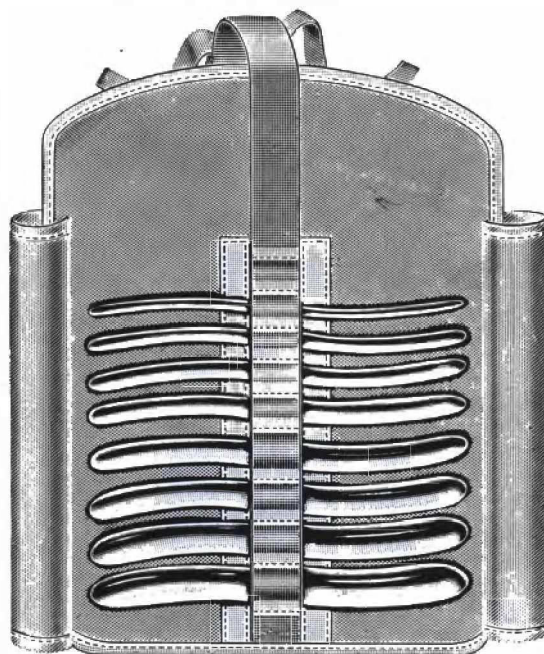

HEGAR  
H170-42508  
3/4 - 17/18 mm  
8 Stück/ea./pces./c./u./pezzi



mm	HEGAR	
3/4 - 17/18	H170-42608	8 Stück/ea./pces./c./u./pezzi
1/2 - 25/26	H170-42613	13 Stück/ea./pces./c./u./pezzi

Uterus-Dilatatoren  
Uterine Dilators  
Dilatateurs utérins  
Dilatadores uterinos  
Dilatatori uterini

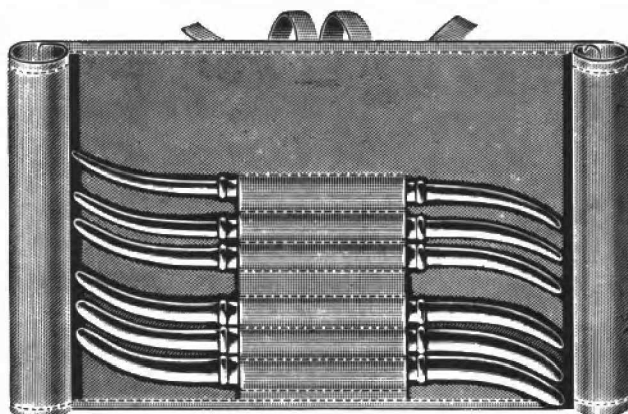
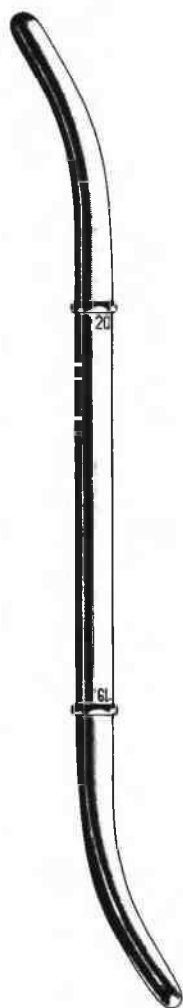

HANK  
H170-43608  
Set/6

mm	HANK	Fig. U.S.
4,5/5	H170-43010	9/10
5,5/6	H170-43012	11/12
6,5/7	H170-43014	13/14
7,5/8	H170-43016	15/16
8,5/9	H170-43018	17/18
9,5/10	H170-43020	19/20
	H170-43506	
	Set/6	

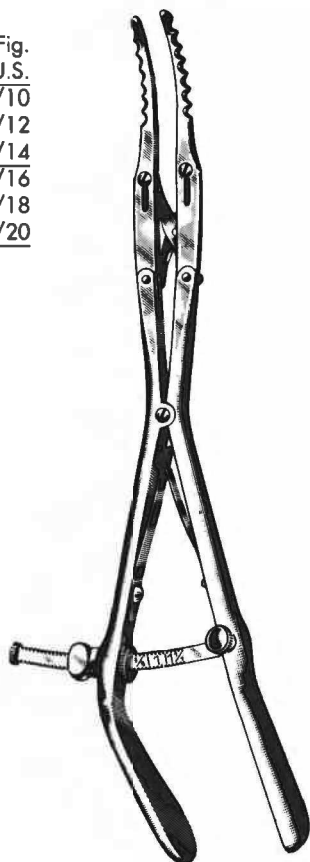

GOODELL  
H170-44134  
34 cm

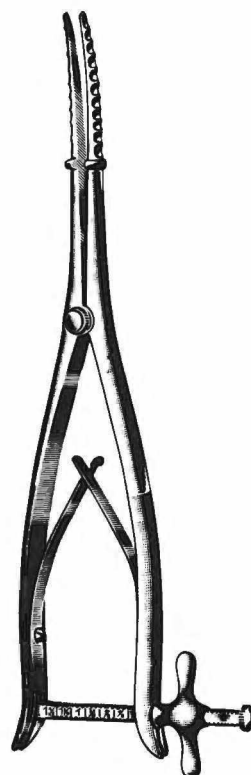

WYLIE  
H170-44329  
29 cm

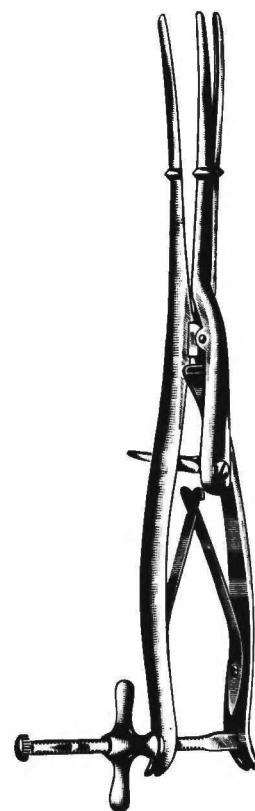

SIMS  
H170-44529  
29 cm



Hakenzangen  
Tenaculum Forceps  
Pinces pour abaissement du col de l'utérus  
Pinzas para coger el cuello del útero  
Pinze per abbassare il collo dell'utero

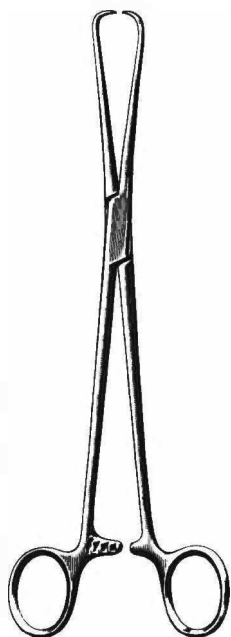

SCHROEDER  
H170-50225  
25 cm

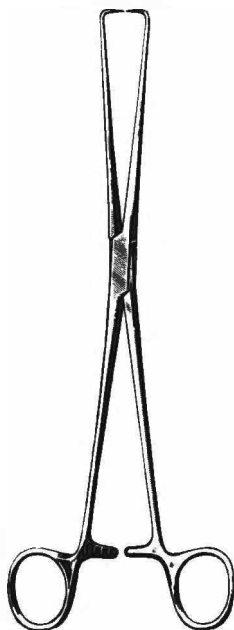

BRAUN  
H170-50425  
25 cm



SKENE  
H170-50524  
24 cm

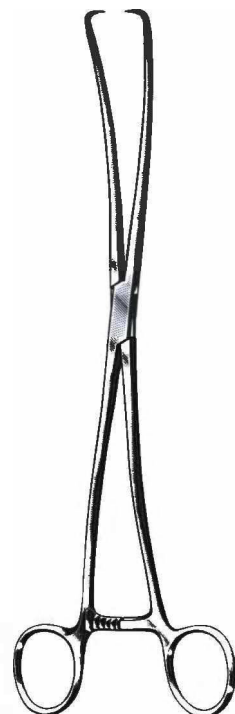

DUPLAY  
H170-50728  
28 cm

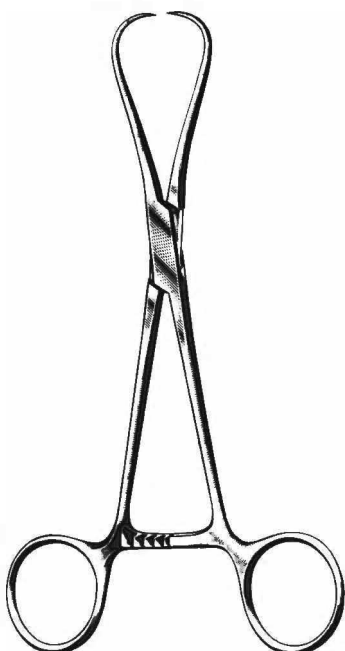

STAUDE-MOORE  
H170-50817  
17 cm

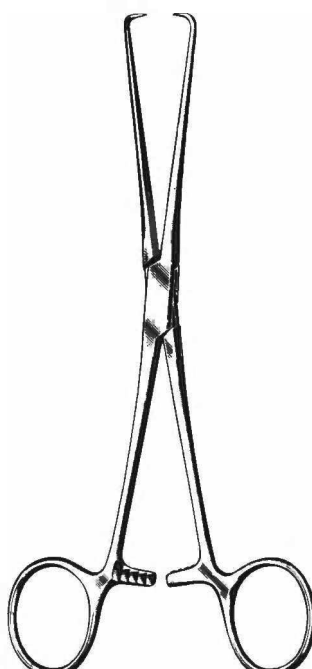

BARRETT  
H170-51018  
18 cm

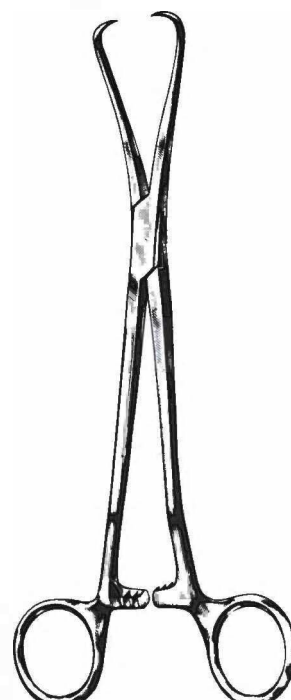

JARCHO  
H170-51220  
20 cm

Hakenzangen  
Vulsellum Forceps  
Pincas pour abaissement du col de l'utérus  
Pinzas para coger el cuello del útero  
Pinze per abbassare il collo dell'utero

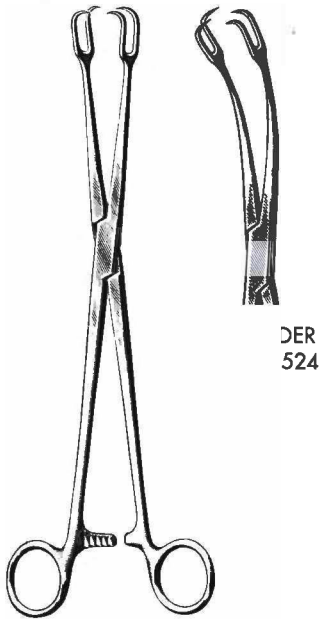

SCHROEDER  
H170-51424  
24 cm

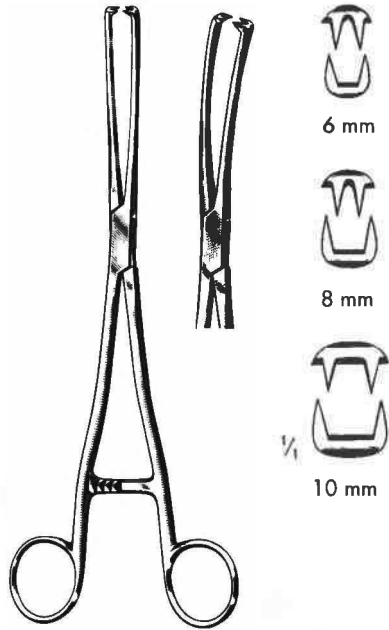

MUSEUX		
H170-52406	6 mm	H170-52506
H170-52408	8 mm	H170-52508
H170-52410	10 mm	H170-52510
24 cm		

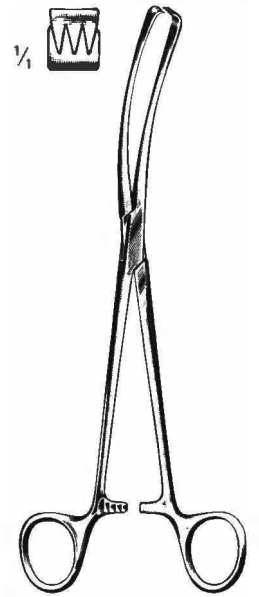

TEALE  
H170-53123  
23 cm

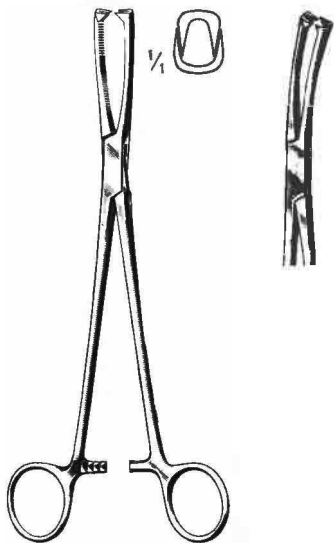

JACOBS  
H170-53221 21 cm H170-53321

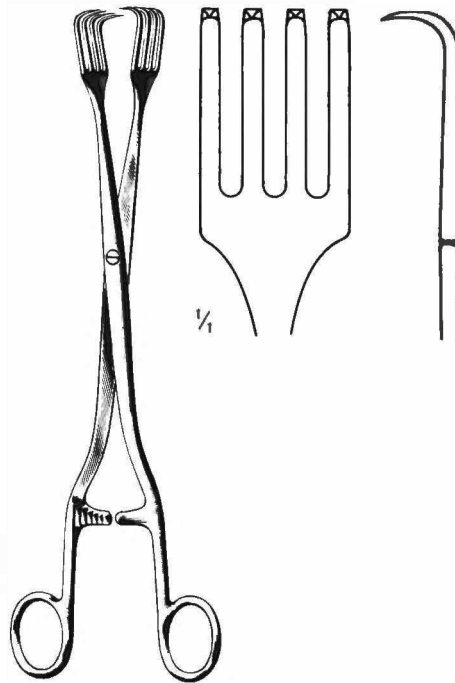

PRATT  
H170-53628  
28 cm



IOWA  
H170-53926  
26 cm



Gynäkologie  
Gynecology  
Gynécologie  
Ginecología  
Ginecologia

170

Uterus-Polypenzangen  
Uterine Polypus Forceps  
Pincès à polypes utérins  
Pinzas para pólipos uterinos  
Pinze per polipi uterini

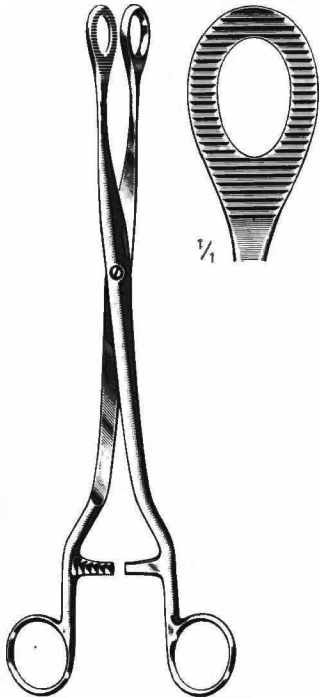

NOTO  
H170-54027  
27 cm

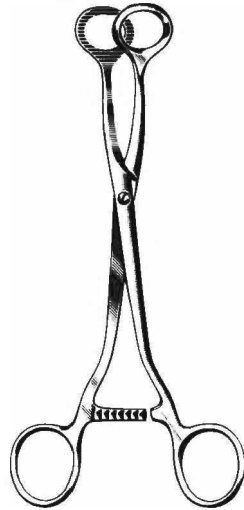

DOYEN  
H170-54220  
20 cm

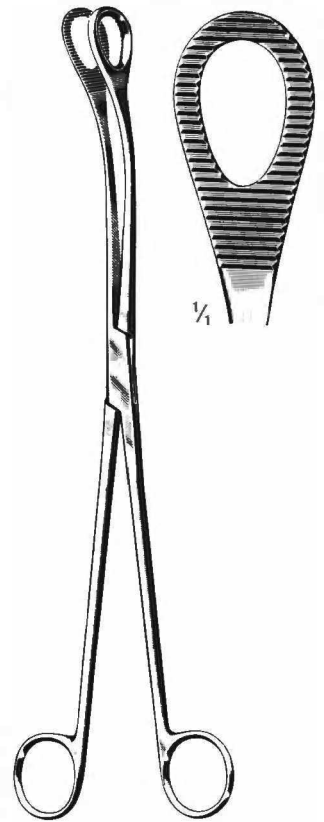

KELLY  
H170-54332  
32 cm

Uterus-Faßzangen  
Uterine Elevating Forceps  
Pincès hystérolabes  
Pinzas para el útero  
Pinze per afferrare l'utero



DARTIGUES  
H170-54527  
27 cm



SOMER  
H170-54723  
23 cm

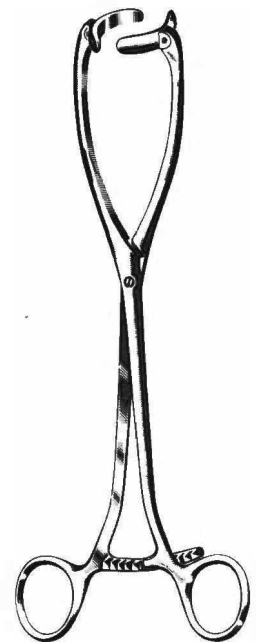

COLLIN  
H170-54925  
25 cm



Amniotom  
Amniotome  
Amniotome  
Amniótomo  
Amniotomo

BEACHAM  
H170-55926  
26 cm



Uterus-Depressoren  
Uterine Depressors  
Dépresseurs utérins  
Depresores uterinos  
Depressori uterini

BRAUN  
H170-56528  
28 cm

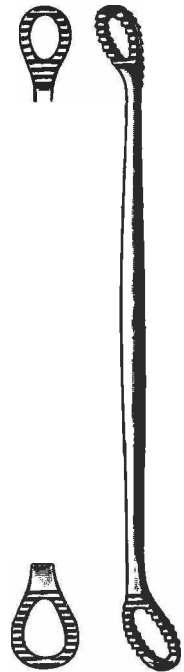

SIMS  
H170-56726  
26 cm



Uterus-Sonden  
Uterine Sounds  
Hystéromètres  
Histerómetros  
Isterometri

starr  
rigid  
rigide  
rigida  
rigida

SIMS  
32 cm

biegsam  
malleable  
malleable  
maleabile  
malleabile

H170-58132



starr  
rigid  
rigide  
rigida  
rigida

MARTIN  
32 cm

biegsam  
malleable  
malleable  
maleabile  
malleabile

H170-58332



COLLIN  
H170-58428  
28 cm

Gynäkologie  
Gynecology  
Gynécologie  
Ginecología  
Ginecologia

170

Uterus-Biopsie-Saugküretten  
Uterine Biopsy Aspirating Curettes  
Curettes aspirantes à biopsie de l'utérus  
Curetas aspiradoras p. la biopsia uterina  
Curette di aspirazione per biopsia



RANDALL  
H170-59004  
24 cm/4 mm

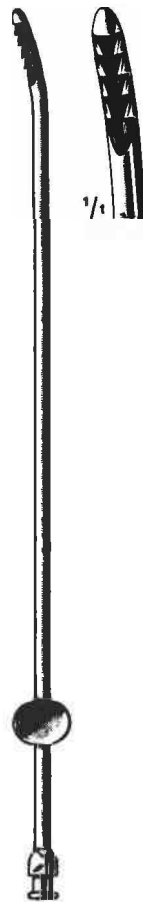

mm	NOVAK
1	H170-59201
2	H170-59202
3	H170-59203
4	H170-59204

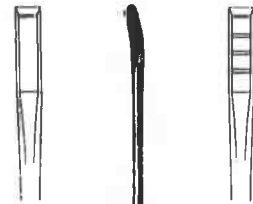

mit Korb  
with basket  
avec grille  
con cesto  
con cestino

KEVORKIAN		
H170-59412	1,2 mm	
H170-59440	4,0 mm	H170-59640
30 cm		

Probeexcisionszangen  
Biopsy Specimen Forceps  
Pincés emporte-pièce pour le col de l'utérus  
Pinzas sacabocado para el cuello del útero  
Pinze taglianti per biopsia



FAURE  
H170-60121  
21 cm



cm	SCHUBERT
21	H170-60421
28	H170-60428

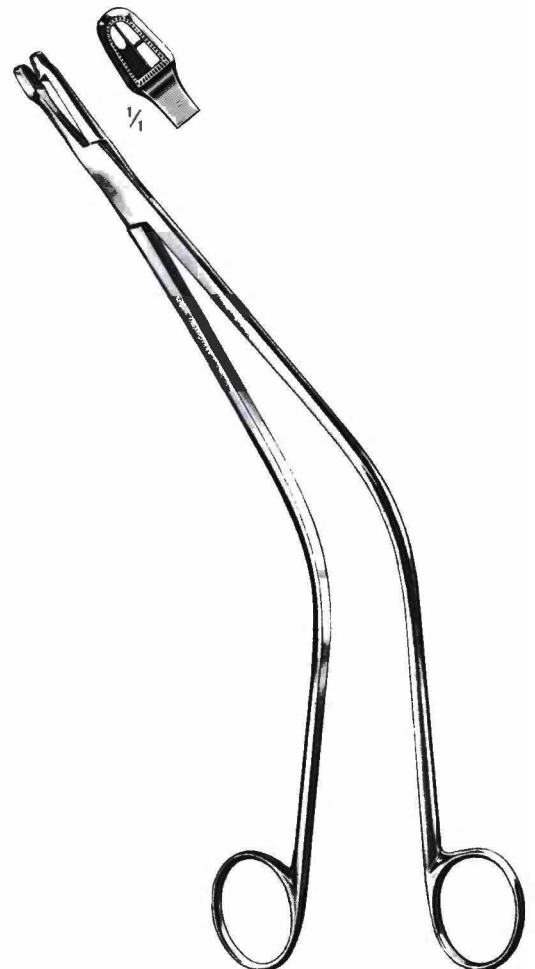

SCHUBERT  
H170-60526  
26 cm

Gynäkologie  
Gynecology  
Gynécologie  
Ginecología  
Ginecologia

170

Biopsiezangen  
Biopsy Specimen Forceps  
Pincès à biopsie  
Pinzas sacabocado p. biopsia  
Pinze per biopsia



THOMS-  
GAYLOR  
H170-60624  
24 cm

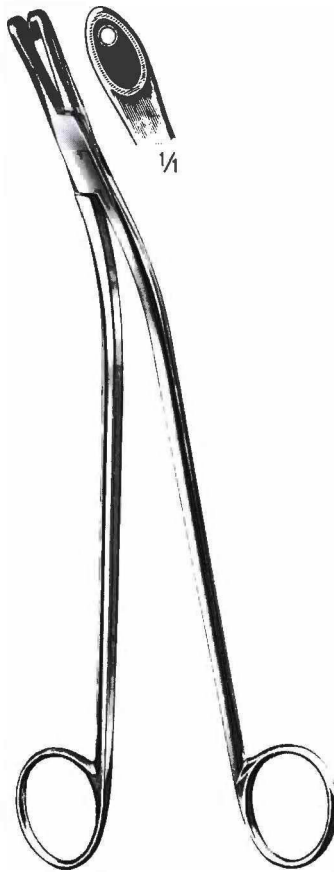

GELLHORN  
H170-60923  
23 cm

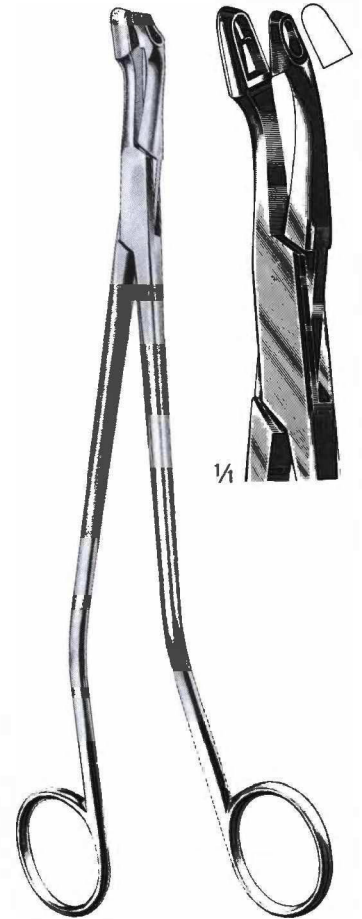

van DOREN  
H170-61125  
25 cm

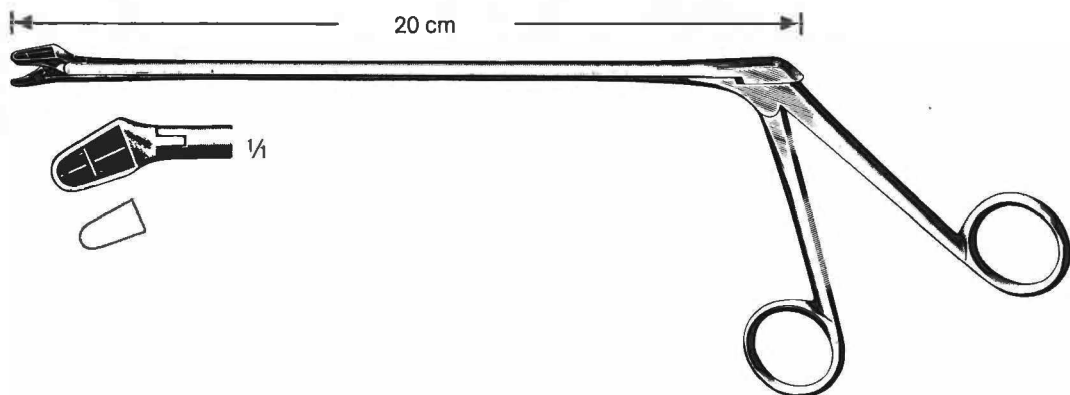

ALEXANDER  
H170-61328  
28 cm



Biopsiezangen  
Biopsy Specimen Forceps  
Pinces à biopsie  
Pinzas sacabocado p. biopsia  
Pinze per biopsia

 H170-61501

 H170-61502

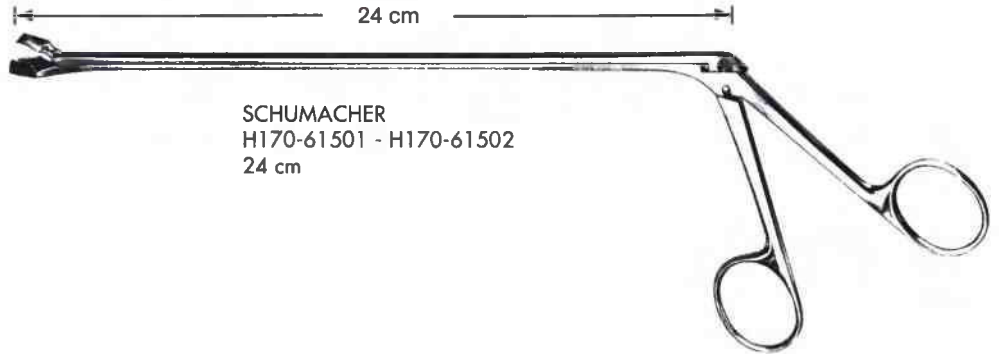

SCHUMACHER  
H170-61501 - H170-61502  
24 cm



  
3 x 9,7 mm

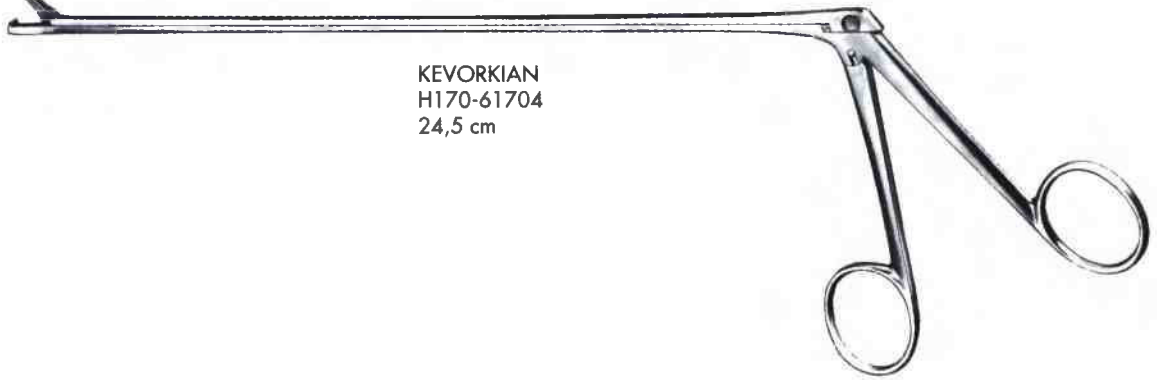

KEVORKIAN  
H170-61704  
24,5 cm



  
4 x 8 mm

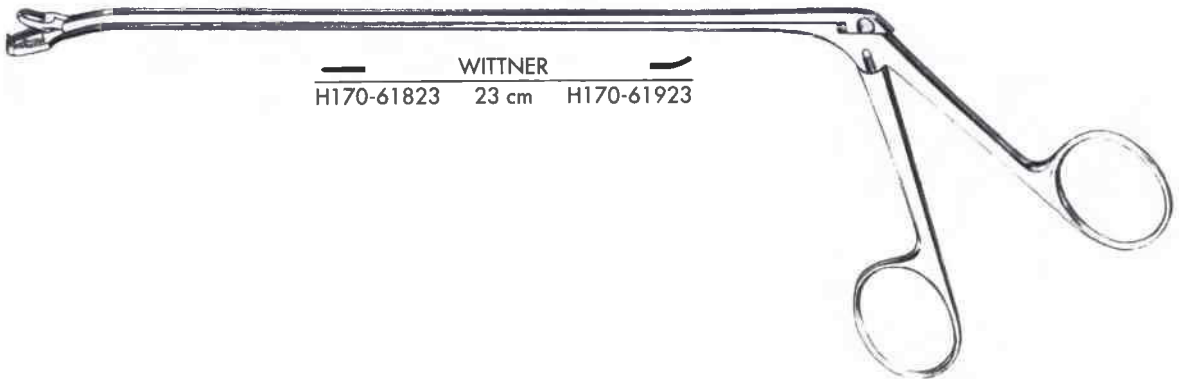

WITTNER  
H170-61823 23 cm H170-61923



  
3 x 7 mm

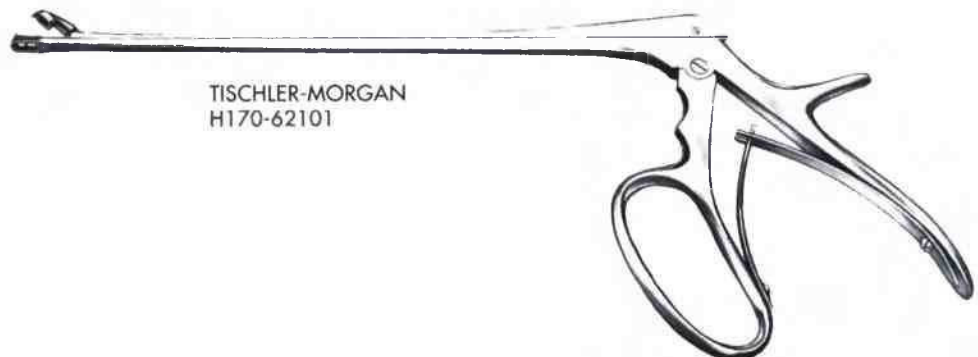

TISCHLER-MORGAN  
H170-62101

Gynäkologie  
Gynecology  
Gynécologie  
Ginecología  
Ginecologia

Biopsiezangen  
Biopsy Specimen Forceps  
Pinces à biopsie  
Pinzas sacabocado p. biopsia  
Pinze per biopsia



oval  
7 x 5 mm

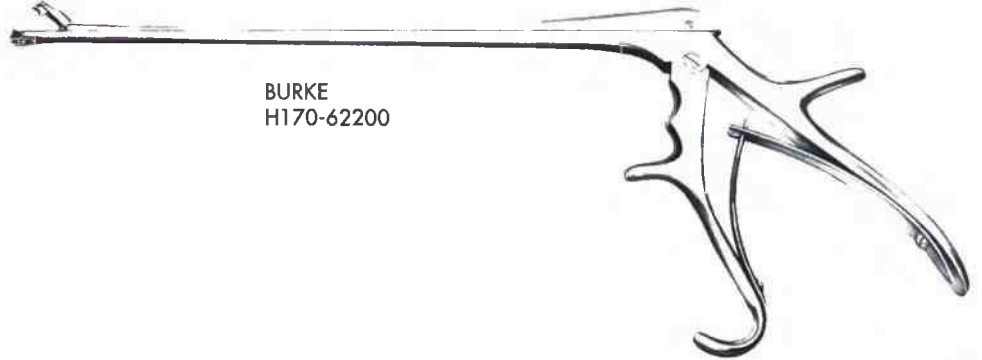

BURKE  
H170-62200



Fig. 1

- TISCHLER-MORGAN

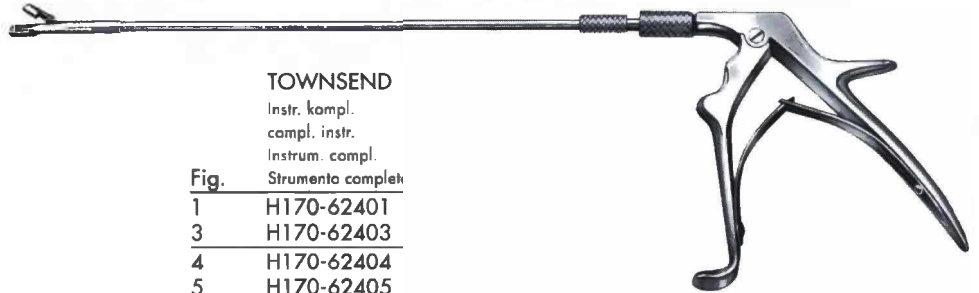

TOWNSEND

Instr. kompl.  
compl. instr.  
Instrum. compl.

Fig.	Strumento complet
1	H170-62401
3	H170-62403
4	H170-62404
5	H170-62405



Fig. 3

oval ● 3,7 x 5 mm



Fig. 5

mini

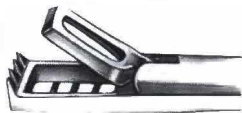
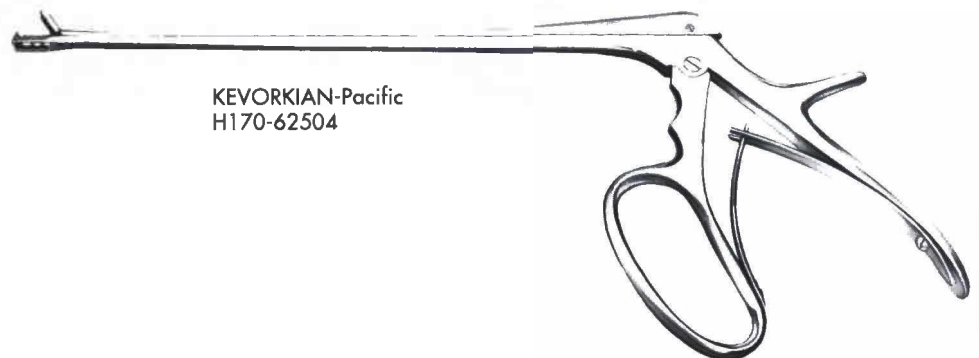

Fig. 4

- KEVORKIAN



3 x 8 mm



KEVORKIAN-Pacific  
H170-62504

Biopsiezangen  
Biopsy Specimen Forceps  
Pinces à biopsie  
Pinzas sacabocado p. biopsia  
Pinze per biopsia

170



2,3 x 4,2 mm

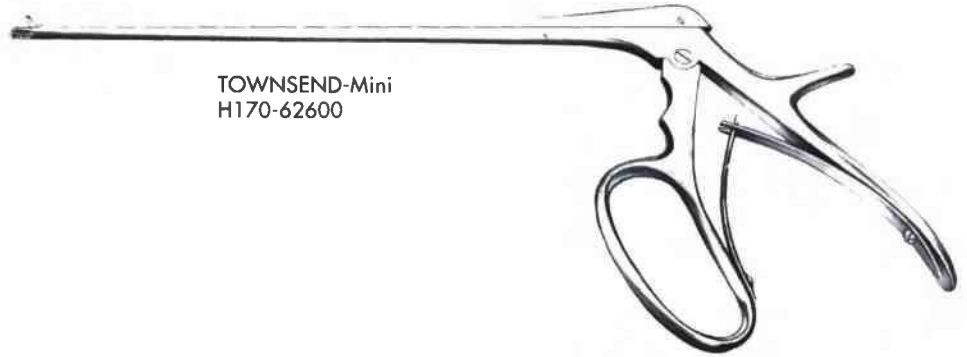

TOWNSEND-Mini  
H170-62600



3 x 9,5 mm

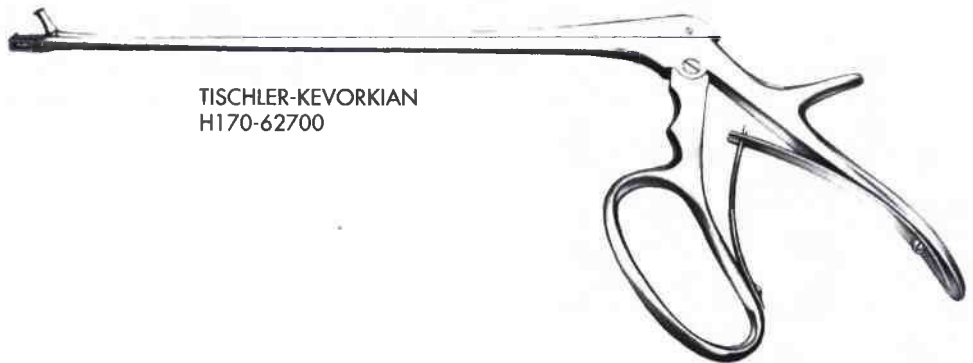

TISCHLER-KEVORKIAN  
H170-62700



4 x 6,5 mm

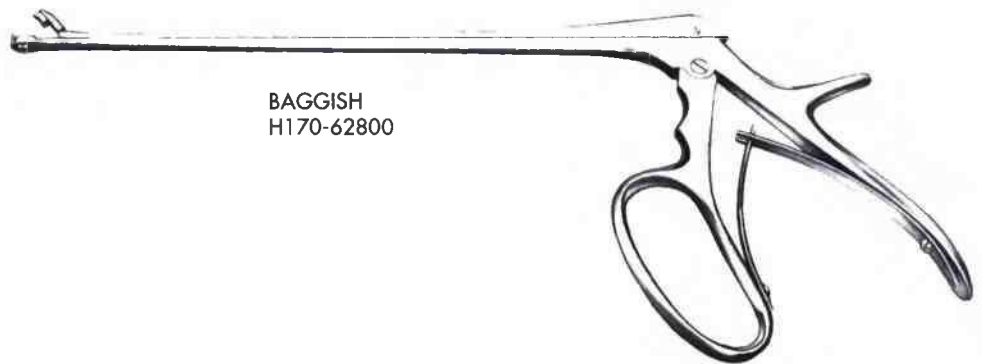

BAGGISH  
H170-62800



4 x 8 mm

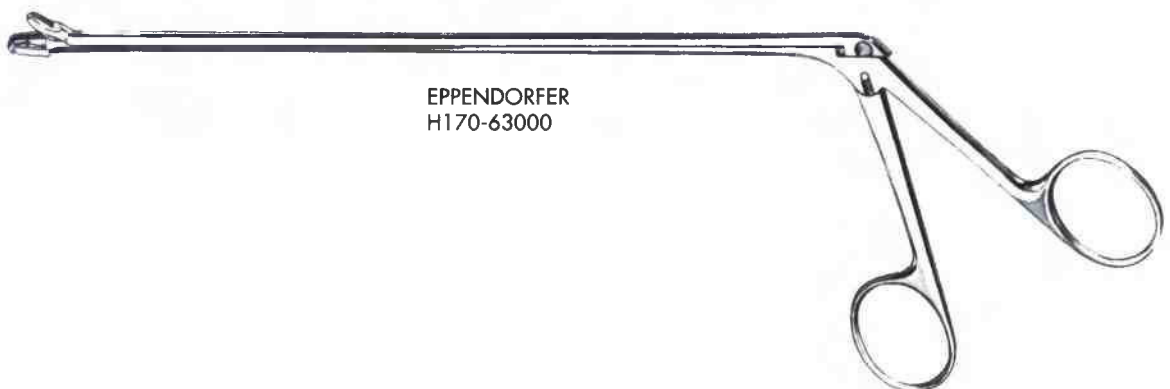

EPPENDORFER  
H170-63000

Biopsiezangen  
Biopsy Specimen Forceps  
Pinces à biopsie  
Pinzas sacabocado p. biopsia  
Pinze per biopsia

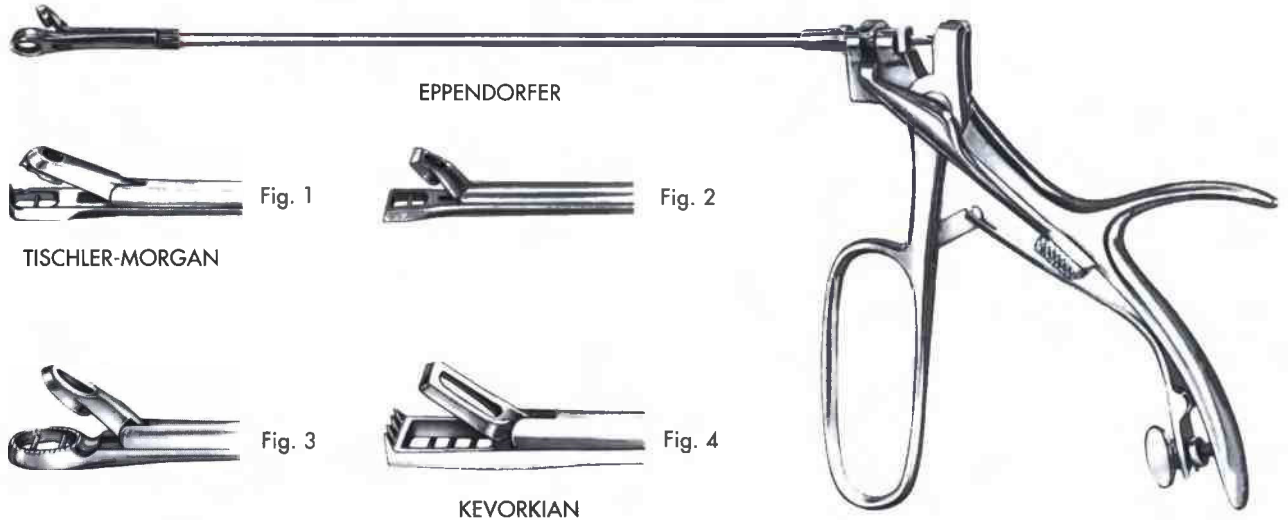

Fig.	Instr. kompl. compl. instr. Instrum. compl. Strumento completo	Aufsatz allein Tip only Embout seul Punta sola
1	H170-63201	H170-63211
2	H170-63202	H170-63212
3	H170-63203	H170-63213
4	H170-63204	H170-63214

Myom-Heber  
Myoma Screw  
Tracteur pour fibromes  
Tirabuzón para fibromas  
Tiramiomi

Myommesser  
Myoma Knife  
Bistouri à fibromes  
Bisturi para fibromas  
Busturi per fibromi

Fistelhaken  
Fistula Hooks  
Crochets à fistules  
Ganchos para fistulas  
Uncini per fistole



DOYEN  
H170-64117  
17 cm

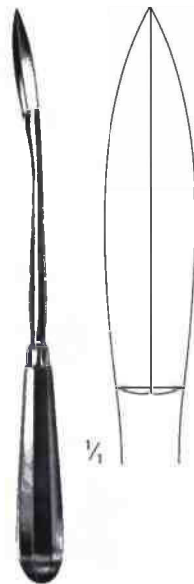

SEGOND  
H170-64327  
27 cm

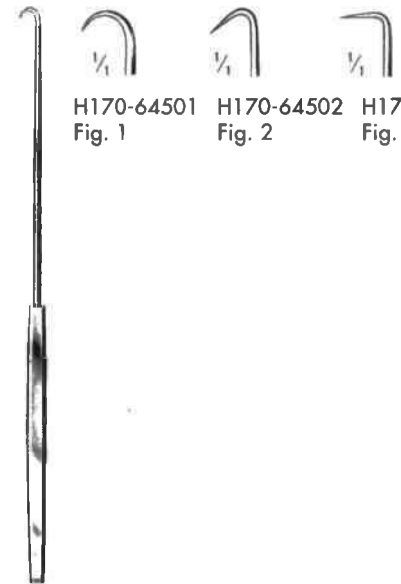

EMMET  
H170-64501 - H170-64503  
22 cm

Salpingograph  
Salpingograph  
Salpingographe  
Salpingógrafo  
Salpingografo

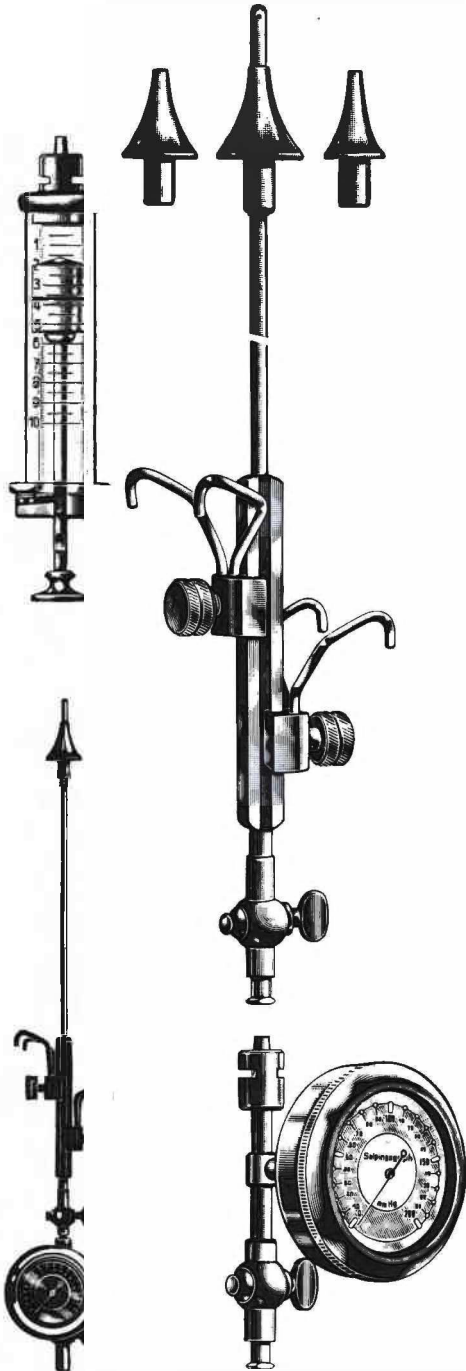

SCHULTZE  
H170-65000  
compl.

scharf  
sharp  
tranchant  
cortante  
tagliente



1



2



3



4



5



6

Uteruslöffel, -kürette  
Uterine Curettes  
Curettes utérines  
Curetas uterinas  
Curette uterine

scharf/stumpf  
sharp/blunt  
tranchant/mousse  
cortante/roma  
tagliente/smussa



BLAKE  
H170-70427  
27 cm

Fig.	SIMON
1	H170-70201
2	H170-70202
3	H170-70203
4	H170-70204
5	H170-70205
6	H170-70206
	25 cm



Gynäkologie  
Gynecology  
Gynécologie  
Ginecología  
Ginecologia

Uterus-Küretten  
Uterine Curettes  
Curettes utérines  
Curetas uterinas  
Curette uterine

170

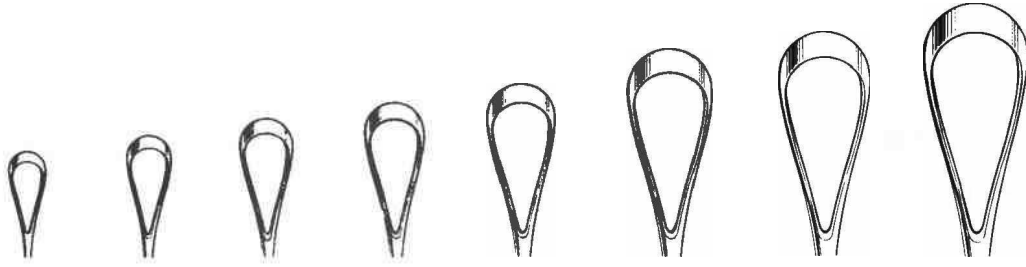

Fig.	00	0	1	2	3	4	5	6
mm	5	6	7	8	9	11	12	14



Fig.	7	8	9	10
mm	15	16	19	20



Fig.	14	15	16
mm	30	35	40

SIMS  
RECAMIER  
BUMM  
H170-71005 - H170-73740

Uterus-Küretten  
Uterine Curettes  
Curettes utérines  
Curetas uterinas  
Curette uterine



Ausführung Features Exécution Ejecución Esecuzione	scharf sharp tranch. cort. tagl.	stumpf blunt mousse roma smussa
fest/rig.	<b>A</b>	<b>B</b>
flex./fless.	<b>C</b>	<b>D</b>

**SIMS**  
H170-71005 - H170-71714  
28 cm

**RECAMIER**  
H170-72007 - H170-72720  
31 cm

**BUMM**  
H170-73030 - H170-73740  
28 cm

Fig.	A	B	C	D	A	B	C	D	A	B	C	D
00	H170-71005	H170-71205	H170-71505	H170-71705								
0	H170-71006	H170-71206	H170-71506	H170-71706								
1	H170-71007	H170-71207	H170-71507	H170-71707	H170-72007	H170-72207	H170-72507	H170-72707				
2	H170-71008	H170-71208	H170-71508	H170-71708	H170-72008	H170-72208	H170-72508	H170-72708				
3	H170-71009	H170-71209	H170-71509	H170-71709	H170-72009	H170-72209	H170-72509	H170-72709				
4	H170-71011	H170-71211	H170-71511	H170-71711	H170-72011	H170-72211	H170-72511	H170-72711				
5	H170-71012	H170-71212	H170-71512	H170-71712	H170-72012	H170-72212	H170-72512	H170-72712				
6	H170-71014	H170-71214	H170-71514	H170-71714	H170-72014	H170-72214	H170-72514	H170-72714				
7					H170-72015	H170-72215	H170-72515	H170-72715				
8					H170-72016	H170-72216	H170-72516	H170-72716				
9					H170-72019	H170-72219	H170-72519	H170-72719				
10					H170-72020	H170-72220	H170-72520	H170-72720				
14									H170-73030	H170-73230	H170-73530	H170-73730
15									H170-73035	H170-73235	H170-73535	H170-73735
16									H170-73040	H170-73240	H170-73540	H170-73740

Geburtshilfe  
Obstetrics  
Accouchements  
Obstetricia  
Ostetricia

Geburtszangen  
Obstetrical (Midwifery) Forceps  
Forceps  
Fórceps obstétricos  
Forcipi

172



WRIGLEY  
H172-10123  
23 cm

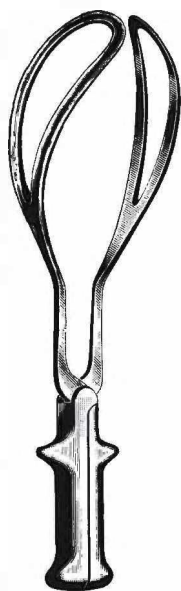

SIMPSON  
H172-10230  
30 cm

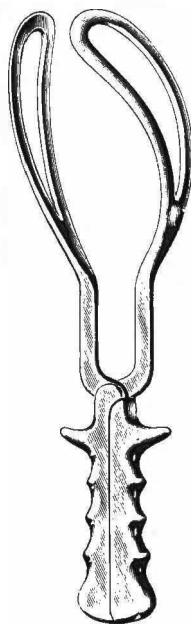

cm	SIMPSON-BRAUN
33	H172-10533
36	H172-10536

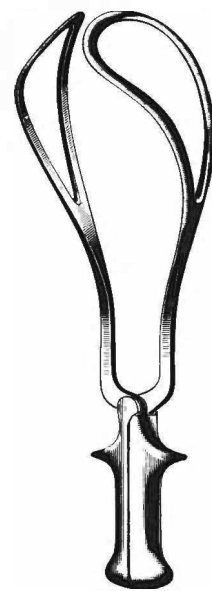

De LEE  
H172-10730  
30 cm

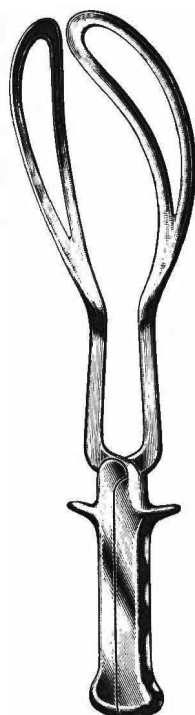

cm	De LEE
36	H172-10836
39	H172-10839

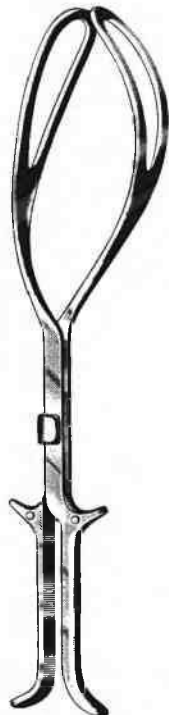

KIELLAND  
H172-11041  
41 cm



cm	ELLIOT
32	H172-11532
38	H172-11538

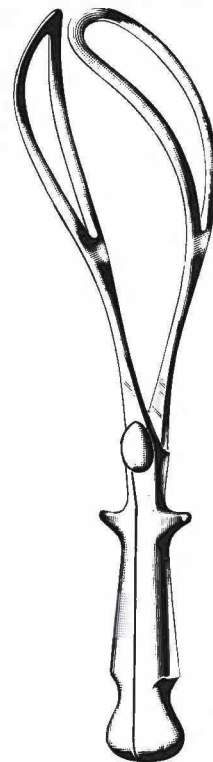

cm	NAEGELE
36	H172-11936
40	H172-11940

Geburtszangen  
Obstetrical (Midwifery) Forceps  
Forceps  
Fórceps obstétricos  
Forcipi

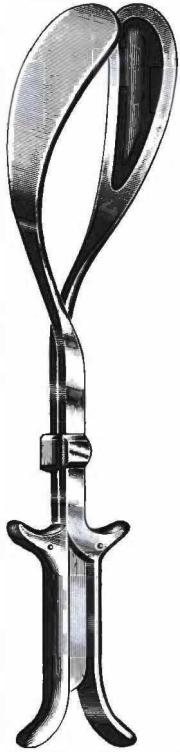

LUIKART  
H172-12540  
40 cm

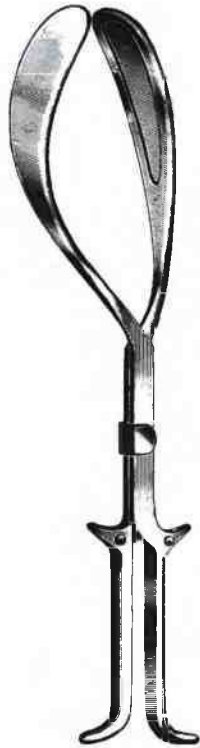

KIELLAND-LUIKART  
H172-12740  
40 cm

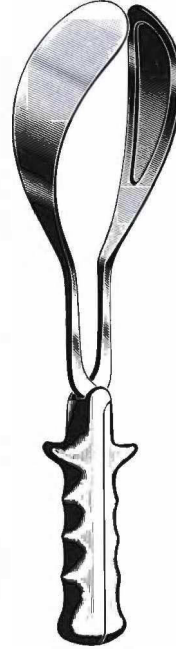

SIMPSON-LUIKART  
H172-13536  
36 cm

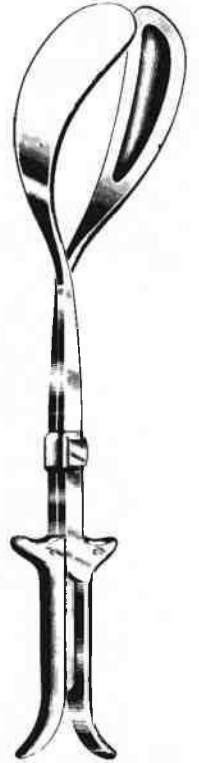

McLEAN-TUCKER-LUIKART  
H172-13940  
40 cm

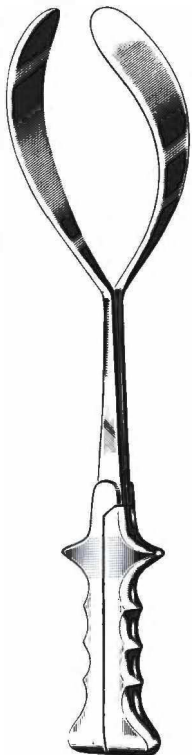

McLEAN-TUCKER  
H172-14139  
39 cm

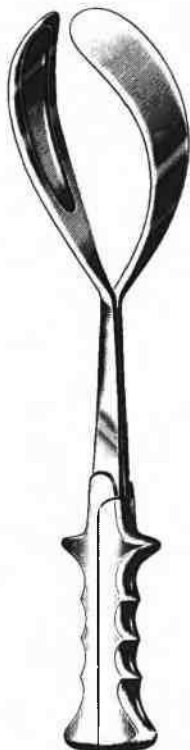

McLEAN-LUIKART  
H172-14339  
39 cm

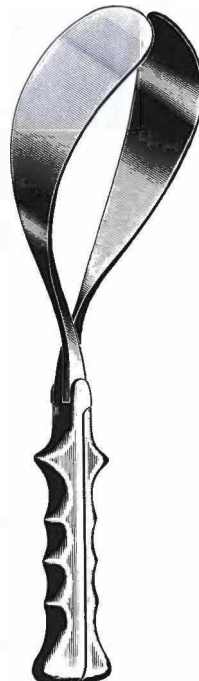

McLEAN  
H172-14536  
36 cm

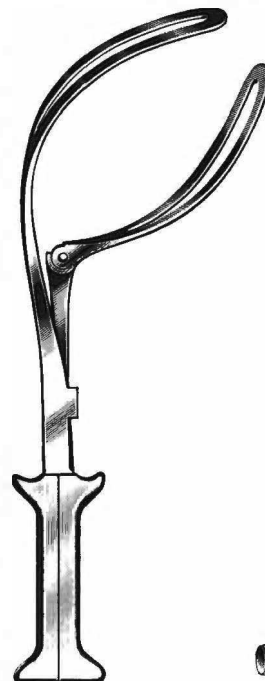

BARTON  
H172-14736  
36 cm

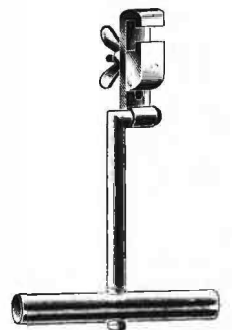

BARTON  
H172-14817  
17 cm

Geburtszangen  
Obstetrical (Midwifery) Forceps  
Forceps  
Fórceps obstétricos  
Forcipi

172

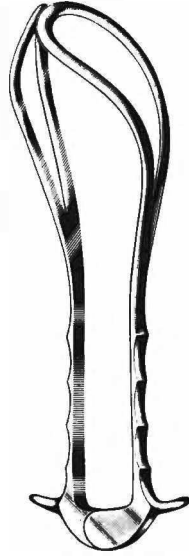

BOERMA  
H172-15129  
29 cm

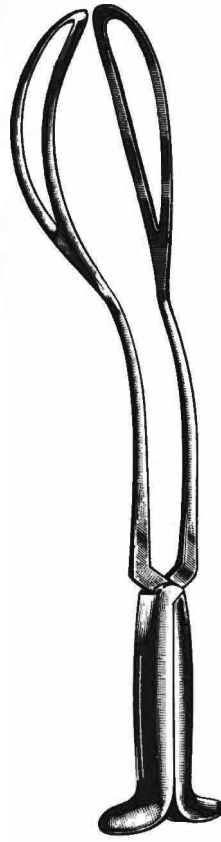

PIPER  
H172-15544  
44 cm



PIPER  
H172-15740  
40 cm



DEWEY  
H172-16037  
37 cm

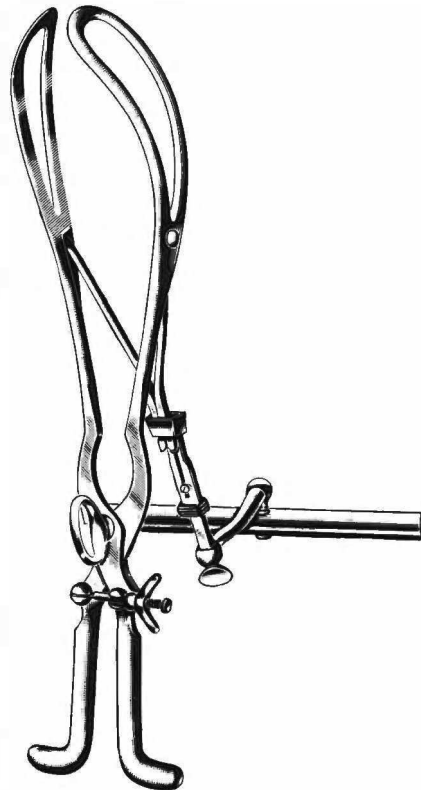

TARNIER  
H172-16240  
40 cm

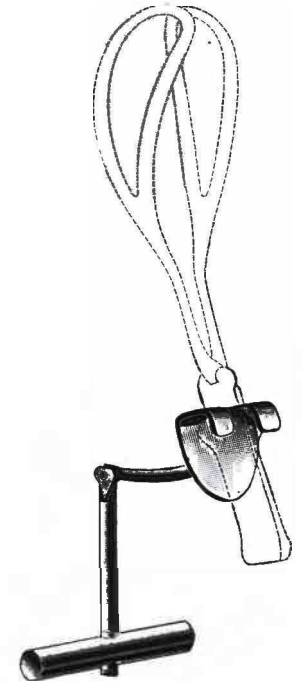

BILL  
H172-17000

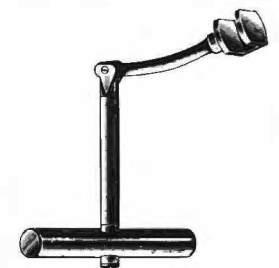

LUIKART-BILL  
H172-17121  
21 cm





SMELLIE  
H172-18133  
33 cm

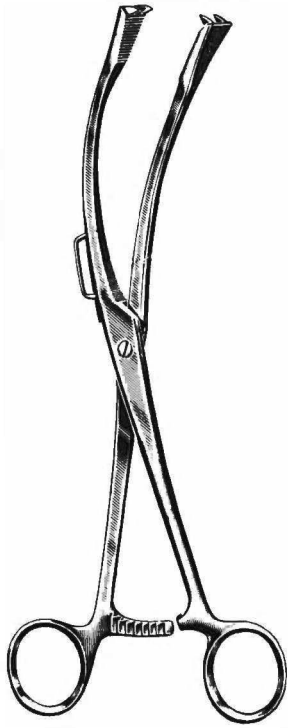

GAUSS  
H172-18327  
27 cm

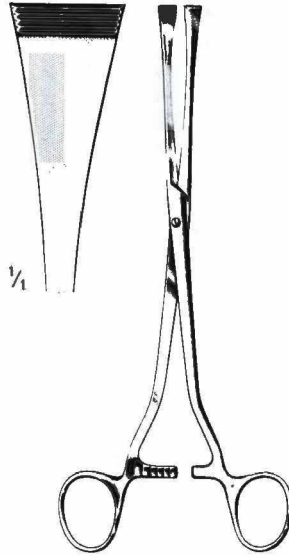

GREEN-ARMYTAGE  
H172-18421  
21 cm



COLLIN  
H172-18709  
9 cm

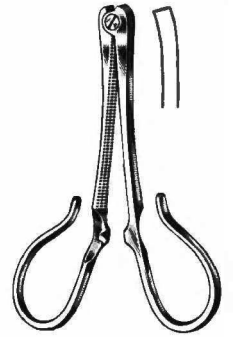

KANE  
H172-18909  
8,5 cm

Beckenzirkel  
Pelvimeters  
Compas pelvimètres  
Pelvimetros  
Pelvimetri

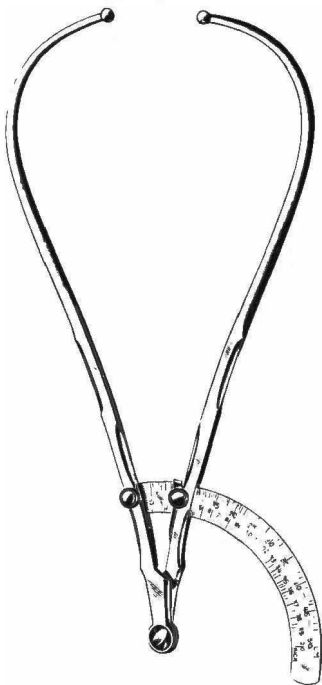

H172-19134  
34 cm

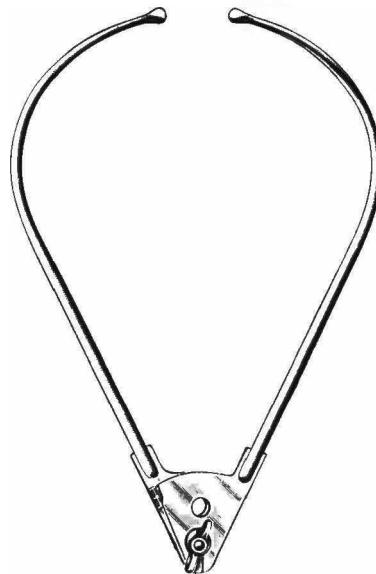

COLIER  
H172-19330  
30 cm

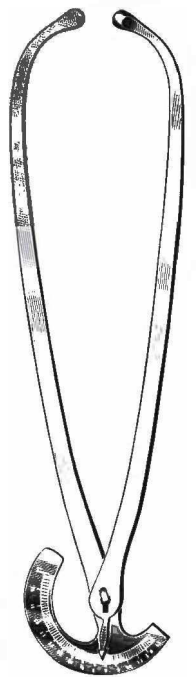

COLLIN  
H172-19535  
35 cm

Geburtshilfe  
Obstetrics  
Accouchements  
Obstetricia  
Ostetricia

172

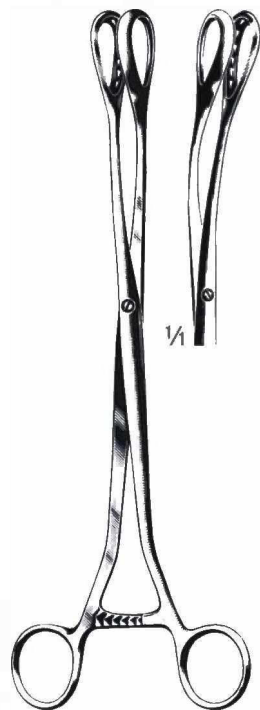

SAENGER  
H172-24227 27 cm H172-24327

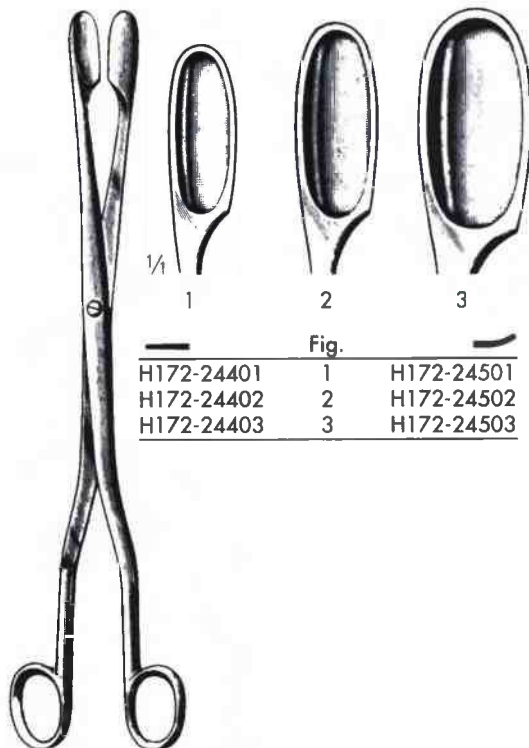

	Fig.	
H172-24401	1	H172-24501
H172-24402	2	H172-24502
H172-24403	3	H172-24503

WINTER  
H172-24401 - H172-24503  
28 cm



PESTALOZZA  
H172-25230  
30 cm



H172-25414 14,5 mm  
H172-25418 18 mm  
H172-25421 21 mm

CUZZI  
H172-25414 - H172-25421  
30 cm

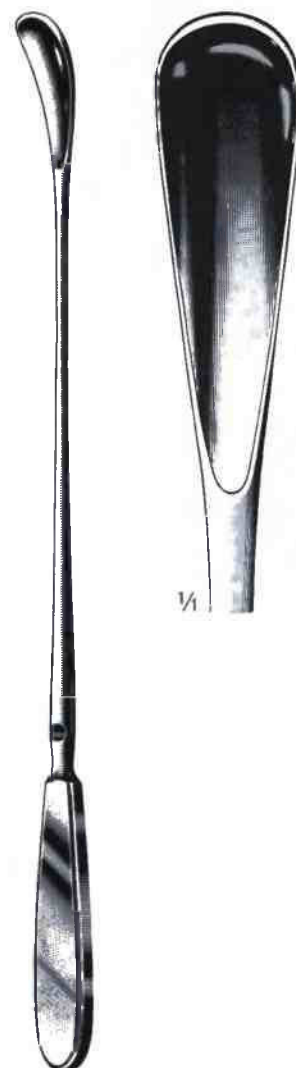

WALLICH  
H172-25642  
42 cm

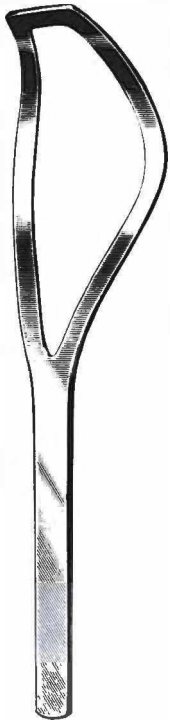

SELLHEIM  
H172-25928  
28 cm

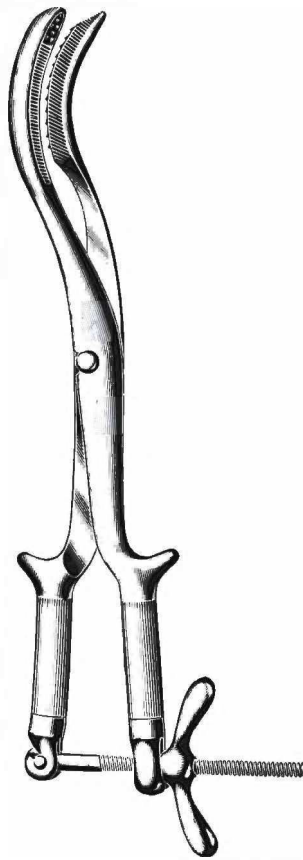

BRAUN  
H172-30242  
42 cm

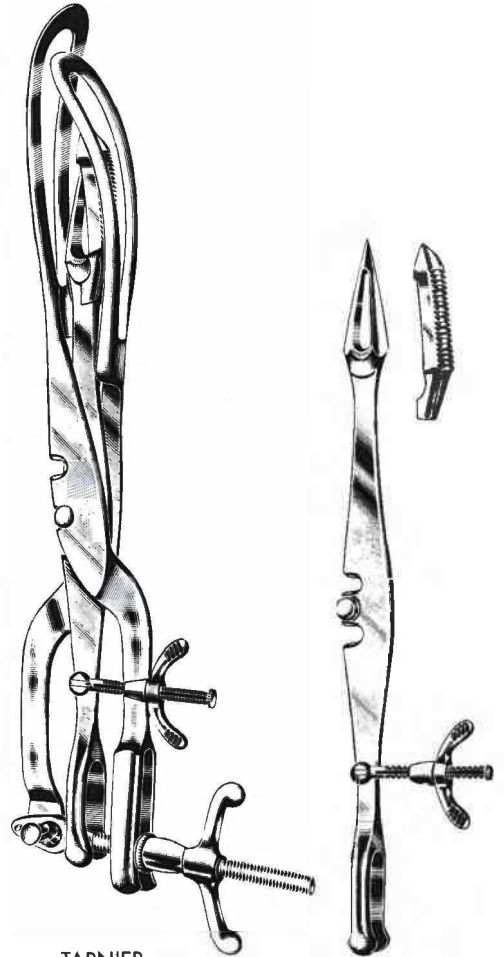

TARNIER  
H172-30446  
46 cm

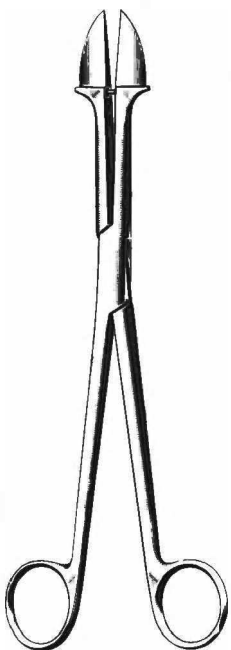

SMELLIE  
H172-30625  
25 cm



BRAUN  
H172-30930  
30 cm

Dermatologie  
Dermatology  
Dermatologie  
Dermatología  
Dermatologia

174



KILNER  
H174-10315  
15 cm



SCHAMBERG  
H174-11110  
10 cm



UNNA  
H174-11314  
14 cm

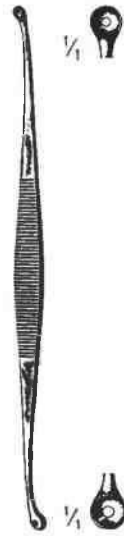

UNNA  
H174-11514  
14 cm



WALTON  
H174-11814  
14 cm



SAALFELD  
H174-12110  
10 cm

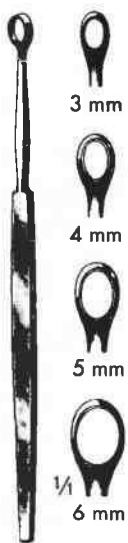

mm	FOX
3	H174-12803
4	H174-12804
5	H174-12805
6	H174-12806

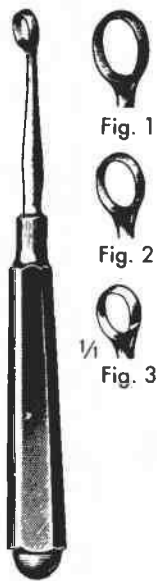
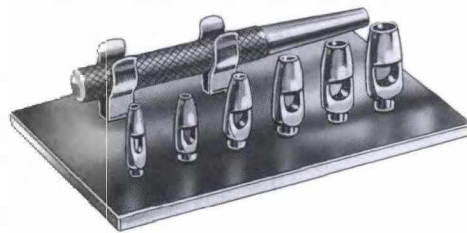
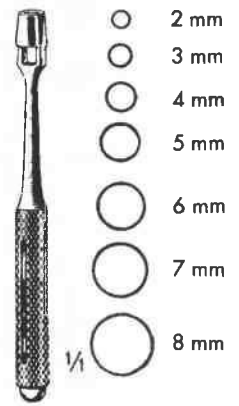

Fig.	PIFFARD
1	H174-13001
2	H174-13002
3	H174-13003



KEYES  
H174-13800  
compl.



mm	KEYES
2	H174-14002
3	H174-14003
4	H174-14004
5	H174-14005
6	H174-14006
7	H174-14007
8	H174-14008

Hygiene  
Hygiene  
Hygiène  
Higiene  
Igiene



H174-30110

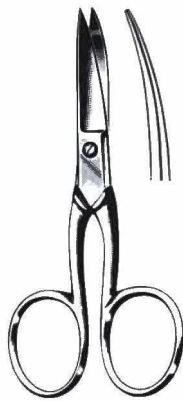

H174-30410 10 cm H174-30510



H174-33114  
14 cm

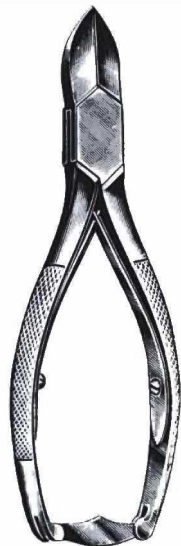

H174-33614  
14 cm



cm	TURNBULL
11,5	H174-34111
13,5	H174-34113

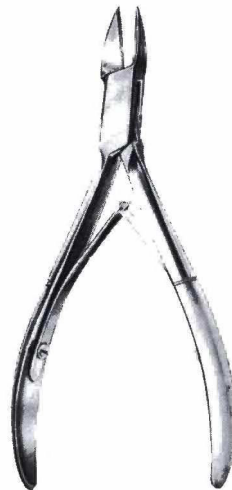

H174-36013  
13 cm



H174-36511  
11 cm



H174-37310  
10,5 cm



H174-37810  
10 cm

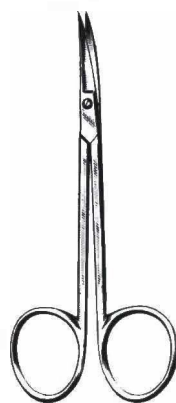

H174-37910  
10 cm



cm	
10	H174-38610
12	H174-38612



H174-39600  
10 Ersatzklingen  
10 Spare Blades  
10 lames de rechange  
10 hojas de repuesto  
10 lame di ricambio

CREDO  
H174-39514  
14,5 cm



Verschiedene Behälter  
Different Containers  
Boîtes diverses  
Contenedores varios  
Vassoi diversi

18/10  
Edelstahl rostfrei  
Stainless Steel  
Acier inoxydable  
Acero inoxidable  
Acciaio inossidabile



SAUERBRUCH  
H188-11021  
210 x 125 x 17 mm

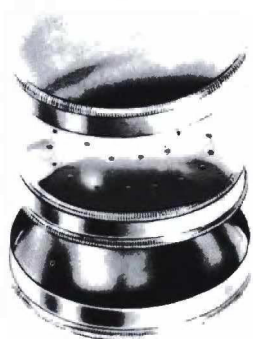

H188-11265  
65 x 15 mm



H188-11365



H188-11400  
150 x 95 x 13 mm



mm x mm x mm			
180	80	40	H188-12018
200	100	60	H188-12020
220	120	60	H188-12022
250	120	60	H188-12025
300	125	60	H188-12030
320	150	60	H188-12032
400	160	75	H188-12040
500	200	120	H188-12050

Instrumentenkästen  
Instrument Cases  
Boîtes à instruments  
Cajas para instrumentos  
Scatole per strumenti



mm x mm x mm			
140	80	50	H188-12414
170	120	60	H188-12417
200	60	40	H188-12420
220	100	50	H188-12422
220	140	60	H188-12423
270	170	60	H188-12427
300	180	65	H188-12430

18/10  
Edelstahl rostfrei  
Stainless Steel  
Acier inoxydable  
Acero inoxidable  
Acciaio inossidabile



mm x mm		
100	100	H188-12510
120	120	H188-12512
150	150	H188-12515
180	180	H188-12518
200	200	H188-12520



Ø mm	
40	H188-13004
60	H188-13006
80	H188-13008
100	H188-13010
120	H188-13012
150	H188-13015

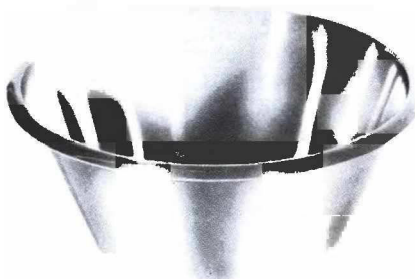

mm x mm			
165	60	0,75	H188-13316
175	70	1,00	H188-13317
220	80	2,00	H188-13322
225	90	2,50	H188-13323
240	110	3,00	H188-13324
255	115	4,00	H188-13325
275	115	4,50	H188-13327
290	125	6,00	H188-13329
310	120	6,00	H188-13331
345	125	8,50	H188-13334
380	130	11,00	H188-13338
415	140	14,00	H188-13341



cm	
17	H188-13917
25*	H188-13925
27	H188-13927

\*standard

Verschiedene Behälter  
Different Containers  
Boîtes diverses  
Contentedores varios  
Vassoi diversi

18/10  
Edelstahl rostfrei  
Stainless Steel  
Acier inoxydable  
Acero inoxidable  
Acciaio inossidabile



l	
0,25	H188-14002
0,50	H188-14005
1,00	H188-14010
2,00	H188-14020



H188-14110  
100 x 20 mm

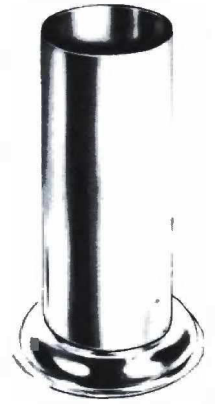

mm x mm		
30	90	H188-14201
50	100	H188-14202
50	130	H188-14203
50	175	H188-14204
75	100	H188-14205
75	130	H188-14206
75	175	H188-14207
100	175	H188-14208
100	200	H188-14209



mm x mm x mm			
200	150	25	H188-14420
260	180	30	H188-14426
300	220	30	H188-14430
350	220	40	H188-14435



Instrumentenschalen  
Instrument Trays  
Plateaux à instruments  
Bandejas para instrumentas  
Bacinelle per strumenti

mm x mm x mm			
220	170	50	H188-14622
280	200	50	H188-14628
320	240	50	H188-14632
370	270	50	H188-14637
420	320	50	H188-14642

18/10  
Edelstahl rostfrei  
Stainless Steel  
Acier inoxydable  
Accero inossidabile  
Acciaio inossidabile



SCHIMMELBUSCH	mm x mm	KONRICH
H188-15208	125 80	H188-18208
H188-15210	125 100	H188-18210
H188-15212	125 125	H188-18212
H188-15508	150 80	H188-18508
H188-15510	150 100	H188-18510
H188-15513	150 130	H188-18513
H188-15515	150 150	H188-18515
H188-15519	150 190	H188-18519
H188-15914	190 145	H188-18914
H188-15916	190 165	H188-18916
H188-15919	190 190	H188-18919
H188-15924	190 240	H188-18924
H188-16414	240 145	H188-19414
H188-16416	240 165	H188-19416
H188-16419	240 190	H188-19419
H188-16424	240 240	H188-19424
H188-16429	240 290	H188-19429
H188-16434	240 340	H188-19434
H188-16439	240 390	H188-19439
H188-16914	290 145	H188-19914
H188-16916	290 165	H188-19916
H188-16919	290 190	H188-19919
H188-16924	290 240	H188-19924
H188-16929	290 290	H188-19929
H188-16934	290 340	H188-19934
H188-16939	290 390	H188-19939
H188-17414	340 145	H188-20414
H188-17416	340 165	H188-20416
H188-17419	340 190	H188-20419
H188-17424	340 240	H188-20424
H188-17429	340 290	H188-20429
H188-17434	340 340	H188-20434
H188-17439	340 390	H188-20439
H188-17914	390 145	H188-20914
H188-17916	390 165	H188-20916
H188-17919	390 190	H188-20919
H188-17924	390 240	H188-20924
H188-17929	390 290	H188-20929
H188-17934	390 340	H188-20934
H188-17939	390 390	H188-20939
H188-17949	390 490	H188-20949
H188-17959	390 590	H188-20959

Sterilisier-Siebschalen  
Sterilization Trays  
Plateaux à stérilisation  
Bandejas de esterilización  
Cestelli per sterilizzazione

18/10  
Edelstahl rostfrei  
Stainless Steel  
Acier inoxydable  
Acero inoxidable  
Acciaio inossidabile

Aus Drahtgeflecht  
Wire Mesh  
En fil inox  
De alambre  
in rete metallica

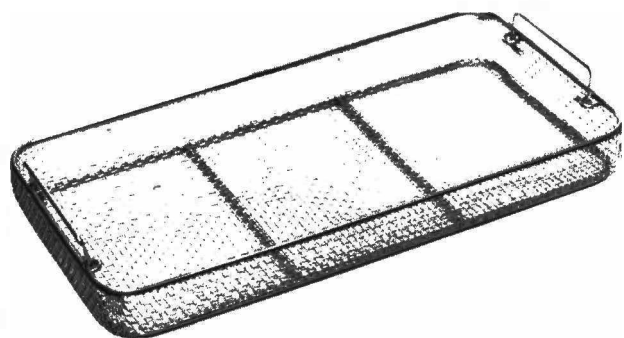

cm x cm x cm			
24	25	5	H188-24024
48	25	5	H188-24048
55	25	5	H188-24055

Aus perforiertem Blech  
From Perforated Sheet Metal  
En tôle perforée  
De chapa de acero perforada  
In acciaio perforato



cm x cm x cm			
26	26	5	H188-25026
48	26	5	H188-25048

Sterilisier-Container und Zubehör auf Anfrage!  
Sterilization Containers and Accessories, upon request.  
Conteneurs pour la stérilisation et accessoires, sur demande.  
Contenedores para la esterilización y accesorios, a solicitud.  
Contentitori per la sterilizzazione e accessori, a richiesta.







H190-01001  
Fig. 1



H190-01002  
Fig. 2  
45°



H190-01003  
Fig. 3  
120°



H190-01011  
Fig. 11  
Ø 3 mm



H190-01012  
Fig. 12  
Ø 5 mm



H190-01013  
Fig. 13  
Ø 8 mm



H190-01014  
Fig. 14



H190-01015  
Fig. 15  
7,0 x 1,5 mm  
45°



H190-01016  
Fig. 16  
7 mm  
45°



H190-01017  
Fig. 17  
6,0 x 1,3 mm



H190-01018  
Fig. 18  
7,0 x 1,7 mm  
30°



H190-01021  
Fig. 21  
7,0 x 1,7 mm



H190-01031  
Fig. 31  
Ø 0,6 mm  
45°



H190-01033  
Fig. 33  
Ø 1,7 mm  
45°



H190-01034  
Fig. 34  
Ø 3,0 mm  
45°



H190-01035  
Fig. 35



H190-01036  
Fig. 36  
90°

Schaft · shaft · tige  
vástago · asta  
Ø 1,6 mm

Elektroden zum Schneiden und Koagulieren  
Cutting and Coagulation Electrodes  
Electrodes pour la coupe et la coagulation  
Electrodos para cortar y para la coagulación  
Elettrodi di taglio e di coagulazione

Serie MICRO + DENTAL



H190-01151  
Fig. 51  
Ø 3 mm  
45°



H190-01152  
Fig. 52  
7,0 x 1,7 mm  
45°



H190-01153  
Fig. 53  
45°



H190-01154  
Fig. 54



H190-01155  
Fig. 55



H190-01156  
Fig. 56  
Ø 5 mm  
45°



H190-01161  
Fig. 61  
45°



H190-01162  
Fig. 62  
90°

Schaft · shaft · tige  
vástago · asta  
Ø 4 mm

Serie STANDARD



H190-02001



H190-02002



H190-02003



H190-02004



Ø mm	
5	H190-02205
10	H190-02210
20	H190-02220



Ø mm	
10	H190-02410
15	H190-02415
20	H190-02420



Ø mm	
2	H190-03002
4	H190-03004
6	H190-03006

Schaft · shaft · tige  
vástago · asta  
Ø 4 mm

Bipolare Koagulation  
Bipolar Coagulation  
Coagulation bipolaire  
Coagulación bipolar  
Coagulazione bipolare

Handchirurgie, Ophthalmologie, Plastische Chirurgie, Experimentelle Chirurgie  
Hand Surgery, Ophthalmology, Plastic Surgery, Experimental Surgery  
Chirurgie de la main, Ophtalmologie, Chirurgie plastique, Chirurgie experimentale  
Cirugía de la mano, Oftalmología, Cirugía plástica, Cirugía experimental  
Chirurgia della mano, Oftalmologia, Chirurgia plastica, Chirurgia esperimentale



H190-10211  
11 cm



H190-10411  
11 cm



H190-10511  
11 cm



H190-10911  
11 cm  
45°



H190-11311  
11 cm  
45°



H190-11511  
11 cm  
45°

Mikrochirurgie, HNO · Microsurgery, ENT · Microchirurgie, ORL · Microcirugía, ORL · Microchirurgia, ORL



H190-12216  
16,5 cm



H190-12316  
16,5 cm



H190-12416  
16,5 cm  
1 mm



H190-12516  
16,5 cm



H190-12716  
16,5 cm  
1 mm

Mikrochirurgie, HNO · Microsurgery, ENT · Microchirurgie, ORL · Microcirugía, ORL · Microchirurgia, ORL



H190-13516  
16,5 cm



H190-13916  
16,5 cm



H190-14216  
16,5 cm



H190-14416  
16,5 cm



H190-14616  
16,5 cm  
1 mm

Gynäkologie, HNO, Tonsillen Chirurgie · Gynaecology, ENT, Tonsil Surgery · Gynécologie, ORL, Chirurgie des amygdales  
Ginecología, ORL, Cirugía de amígdalas · Ginecologia, ORL, Chirurgia tonsillare



H190-15219  
19,5 cm



H190-15419  
19,5 cm  
1 mm



H190-15719  
19,5 cm  
1 mm



H190-15919  
19,5 cm  
2 mm



Bipolare Koagulation  
Bipolar Coagulation  
Coagulation bipolaire  
Coagulación bipolar  
Coagulazione bipolare

190

Neurochirurgie · Neurosurgery · Neurochirurgie · Neurocirugía · Neurochirurgia



H190-16219  
19,5 cm



H190-16419  
19,5 cm  
1 mm



H190-16619  
19,5 cm  
2 mm



H190-16719  
19,5 cm  
1 mm



H190-16919  
19,5 cm  
1 mm



H190-17203  
0,3 mm



H190-17207  
0,7 mm



H190-17212  
1,2 mm

H190-17203 - H190-17212  
22,5 cm  
0,3 mm - 1,2 mm

Anschlußkabel  
Connection Cords  
Cordons d'alimentation  
Cables de conexión  
Cavi da connessione



m				
3	H190-19030	H190-19130	H190-19230	H190-19330
5	H190-19050		H190-19250	H190-19350
	ERBE SELECT	AESCLAP	USA Mod.	MARTIN

HF-Chirurgie-Geräte  
Electrosurgery Equipment  
Electrobistouris  
Electrobisturías  
Elettrobisturi

# Inhaltsübersicht

Gruppe		Seite
102	Diagnostik	1- 7
104	Anaesthesie	8- 9
106	Skalpelle, Messer	10- 16
108, 109	Scheren	18- 33
110, 111	Pinzetten	34- 40
112	Arterienklemmen	42- 57
112	Schlauchklemmen	58
114	Tuchklemmen	59
116	Tupferzangen, Kornzangen	60- 63
118	Wundhaken, Wundsperrer	64- 87
120	Sonden, Watteträger	88- 89
122	Trokare, Punktionsnadeln	90- 91
124, 126	Naht	92- 104
128	Sterilisierhilfen	105
130	Gipsverband	106- 108
132 -136	Orthopädie, Osteosynthese	109- 166
140	Neurochirurgie, Laminektomie	167- 177
142	Ophthalmologie	178- 197
144	Otologie	198- 211
146	Rhinologie	212- 229
148	Mund und Zunge	230- 234
150	Tonsillen	235- 238
152	Larynx	239- 241
153	Flexible Endoskopie-Zangen	242- 244
154	Tracheotomie	245- 246
154	Kropf	247
156	Thorax	248- 255
162	Galle	256- 257
164	Niere	258
164	Darm, Magen	259- 266
166	Urologie	267- 271
168	Mastdarm	272- 275
170	Gynäkologie	276- 299
172	Geburtshilfe	300- 305
174	Dermatologie, Hygiene	306- 307
188	Behälter, Siebschalen	308- 312
190	Hochfrequenz-Chirurgie	314- 319

	Seite		Seite		Seite
Abziehstein, Arkansas	16	MIXTER Baby	52	BARNHILL Ring Messer	229
Adapter, ALAN PARKS Kaltlicht	273	PEAN grazil	45	BARR Rektal Spekulum	272
Adenotom, LAFORCE	229	PEAN kurzfassend	47	BARRAQUER Cilien Pinzette	197
ADLERKREUTZ Pinzette	36	PENNINGTON	46	Colibri Iris-Pinzette	189
ADSON Arterienklemmen	48	PRATT	47	Colibri Sperr-Elevator	178
Baby Wundsperrerr	77	PROVIDENCE HOSPITAL	44	Colibri Iris Schere	32
BROWN Pinzette	35	ROBERTS	50	Fixier Pinzette	192
Dura Haken	168	ROCHESTER CARMALT	46	KATZIN Iris Pinzette	189
Elevatorium	128	ROCHESTER OCHSNER	45	Keratoplastik Messer	181
Hohlmeißelzange	110	ROCHESTER PEAN	45	Nadelhalter	97
Hypophysen Pinzette	170	SPENCER WELLS	46	Vorderkammer Pinzette	191
micro Pinzetten	35	TOENNIS	50	BARRETT Haken Zange	286
Nadelhalter	94	TUFFIER	47	BARTON Geburts Zange	301
Pinzetten	35	ASCH Septum Richtzange	228	Zughebel	301
Saugrohr	171	Aufreiber, KUENTSCHER,		Batteriegriffe	9
TOENNIS neurochir. Schere	26	für Femur	143	Bauchdeckenhaken, COLLIN	86
Wundsperrerr	77	AUFRIECHT Nasen Raspel	224	DOYEN	74
AEBLI Hornhaut Scheren	22	Nasentrücken Haken	227	SIMON	74
ALAN PARKS Kaltlicht Adapter	273	Aufsatz, BRUENINGS	240	Bauchdeckenhalter, BALFOUR	84
PARKS Rektal Spekulum	273	CORDES	240	BALFOUR Baby	84
ALBEE Fräser	137	FRAENKEL	240	COLLIN	86
ALEXANDER Biopsie Zange	292	KEVORKIAN	296	GOSSET	83
Flachmeißel	121	KRAUSE	240	KIRSCHNER	85
Hohlmeißel	121	LANGE	240	O'SULLIVAN O'CONNOR	83
MATSON Raspatorium	128	Aufsätze, Uterusbiopsie	294,294	Bauchspatel, REVERDIN	66
Raspatorium	126	Aufsatz, ROSENBERG	240	RIBBON	66
ALLIS ADAIR Zangen	259	SCHEINMANN	240	BAUMGARTNER Nadelhalter	92
JUDD Zange	259	SCHUMACHER	240	BEACHAM Amniotom	289
THOMS Zange	259	SEIFFERT	240	BECKER Cystotom biegsam	182
ALLISON Lungen Spatel	253	TISCHLER KEVORKIAN	294	BECKMANN EATON Wundsperrerr	78
ALM Wundsperrerr	76	TISCHLER MORGAN	294,296	Ringmesser	229
ALVIS Fremdkörper Kürette	182	TOWNSEND	294	Wundsperrerr	78
Amniotom, BEACHAM	289	Ausschläger, Einschläger,		BEEBEE Schere	29
Amputation, PERCY Retraktor	133	Marknägel	142	BEER Cilien Pinzette	197
Amputations Messer	15	Autopsie Besteck	124	BEESON Gips Spreizer	108
ANDREW Zungen Drücker	230	AUVARD Scheidenspekula	282	BELLUCCI Scheren mikro,	
Anlege Zange für Clips	177	AXENFELD Chalazions-Löffel	183	mikro-mini	205
Anuskop, HIRSCHMANN	274	AYER Chalazions-Pinzetten	195	BENGOLEA Arterienklemme	48
IVES FANSLER	274	BABCOCK Darmfaß-Zängchen	259	BENNETT Knochenhebel	129
ARCHER Splitterzange	38	BABINSKY Hammer	6	BERENS Lanzen Messer	180
Arkansas Abziehstein	16	Backen für MEAD Hammer, Ersatz	125	BERGMANN Gips Säge	106
ARLT Draht Schlingen	184	BACKHAUS Tuchklemmen	59	Verband Schere	30
ARRUGA Extraktionshaken	182	BAGGISH Biopsie Stanze	295	BERKE Muskel Pinzette	191
GILL Kapsel Pinzette	192	BAILEY Baby Rippen-Kontraktor	253	BERLINER Hammer	6
KALT Nadelhalter	97	GIBBON Rippen-Kontraktor	253	BERNHARD Tuchklemme	59
Kapsel Pinzette	193	Rippen Rippen-Kontraktor	253	BERTILLON Meßzirkel	7
Nadelhalter	96	BAINBRIDGE Arterienklemme	53	BEST Darm Klemme	263
Netzhaut Ablös Schützer	184	BAKES Gallenstein-Sonden	257	Besteck, Autopsie	124
Sperr-Elevator	178	BALFOUR		Econom Universal Diagnostik	3
Arterienklemme, ADSON	48	Baby Bauchdeckenhalter	84	Kombination Diagnostik	3
ADSON Baby	48	Bauchdeckenhalter	84	NABATOFF Varicen	88
BAINBRIDGE	53	BALLENGER HAJEK		Otoskop	3
BENGOLEA	48	Septum Elevatorium	222	Sägen Bohrer Fräser	138
CHAPUT	47	Schwingmesser	221	Universal Diagnostik	3
COLLIN	47	Septum Elevatorium	222	Wundklammer in Metalletui	105
CRILE	45	SLUDER Tonsillotom	238	BETHUNE Rippen Schere	249
CRILE RANKIN	45	Tonsillen Faß-Zange	237	BEUSE Schere gezahnt	23
CRILE TITAN	45	Band, PARHAM allein	118	BEYER Hohlmeißelzange	111
DANDY	46	Bandmaß cm/Zoll-Teilung	7	Stanze	218
HARTMANN	42	Bandschlingen-Elektrode	315	Biegezange,	
HEISS	48	BANGERTER		Draht-, und Schneide-	141
KELLY	45	Cyclodialysen-Spatel	184	BILL LUIKART Zughebel	302
KELLY RANKIN	45	BARANY Lärmtrommel	200	Zughebel	302
KELLY TITAN	45	BARBARA Häkchen	210	BILLEAU Ohr Schlinge	203
KOCHER grazil	45	Nadeln	210	Biopsie- und Koagulationszange	243
LERICHE	48	Picks	210,211	Biopsie Zangen flexibel	242-244
LOVELACE	46	BARKAN Goniotomie Messer	181	Bipol Kabel	319

	Seite		Seite		Seite
Bipol Pinzetten	316-318	BRUENINGS Nasenzange scharf	215	CLAR Stirnlampen	4
BIRCHER GANSKE		Ohrspekulum pneumatisch	198	CLARK Sperrelevator	178
Knochenhalte Zange	117	Septatom	221	CLEVELAND Hohlmeißelzange	109
Meniskotom	131	Tonsillenschnürer	237	Clip-Anlegezange, McKENZIE	166
BISHOP HARMAN Iris-Pinzetten	190	Verlängerungsrohre	240	SMITHWICK	166
Bläser, Kabierske, Pulver	200,201	Zangen Aufsatz	240	SWEET	166
BLAKE Galleinstein Zangen	256	Zungen Spatel	230	CLOWARD Spreizer Wirbelkörper	171
Kürette doppelt	297	BRUNETTI Wirbelsäulenmeißel	124	Valven	79
MAYO Gallenstein Zangen	256	BRUNNER Darm Klemme	263	Wundsperrer	79
Bleihand	118	Führungshohlsonden	100	COAKLEY Antrum Küretten	228
BLOHMKE Tonsillen Faß-Zange	237	Rippen Schere	249	Trokar für Kieferhöhle	90
BLOUNT Knie Haken	131	BRUNS scharfe Löffel	119	COLCLOUGH Stanzen	175
Knochenhebel	131	Verband Scheren	30	COLLIER Nadelhalter	92
BLUMENTHAL		BRYANT Tupfer Klemme	62	COLLIN Arterienklemmen	47
Hohlmeißel Zangen	109	BUCHWALD Zungen Spatel	230	Bauchdeckenhalter	86,87
Blutdruckmesser	1	BUCK Hammer	6	Becken Zirkel	303
Blutschnäpper, FRANKE	2	Hebel Fremdkörper	204	DUVAL Pinzette	36
BODENHAMMER		Ohr Küretten	201	Dynamometer	2
Rektal Spekulum	272	Ohr Messer	202	Hammer	125
BOEHLER Extensionsbügel	140	BUIE Saug Kanüle	275	HARTMANN Wundhaken Draht	65
Hohlmeißel Zange	111	SMITH Rektumspreizer	273	Nabelschnur Klemme	303
Knochensplitterzange	113	BUMM Küretten	299	Skalpelli griffe	10
Nagel	149	BUNGE Exenterations Löffel	183	Spekula	276
BOERMA Geburts Zange	302	BUNNELL Bohraparat	135	Uterus Faßzange	288
BOETTCHER Tonsillenschere	23	Sehnenstripper	132	Uterus Sonde	289
Bohrapparat, BUNNELL	135	BUNT Sterilisierklammer	105	Wundklammerzange	104
MOORE	134	BURCH Fixier Gabel	181	Zungen Zange	231
RALK	135	LISTER Sperrelevatorium	178	COLLYER Becken Zirkel	303
STILLE	134	BURKE Biopsie Stanze	294	COLVER Tonsillen Faßzange	236
STILLE SHERMAN	134	BUSCH Nabelschnur Schere	26	CONNIN AMSLER	
Bohrdraht Stützen	135	CARMALT ROCHESTER		Markier Instrument	185
Bohrer, Fingernagel	133	Arterienklemme	46	CONVERSE Nasenplastik Messer	220
Gewinde-	145	Splitterpinzetten	38	COOLEY Atrauma Pinzette	40
McKENZIE	134	CARPENTER		COOPER Nadel	98
Bohrwinde, HUDSON	134	Tonsillennmesser, Dissektor	235	CORDES Zangen Aufsatz	240
BONACCOLTO		CASPAR Gegensperrer	80,82	CORWIN	
Strabismus Pinzette	190	Haken	81	Tonsillen Kompressorium	237
Bonn Iris Pinzetten	190,190	Halsweichteilsperrer	80	CORYLLOS (Thorax) Wundhaken	75
Bonn Spül Kanülen	196	Laminektomie Wundsperrer	81	Rippen Schere	249
Bonn TITAN Iris Pinzette	191	Muskelabspreizer	82	COS Zängchen Drahtbiege-	206
BORCHARDT Fräser	137	Valven	80,82	COTTLE Haken	227
BOSE Trachealhäkchen scharf	245	CASTANEDA ALU Rippensperrer	252	KAZANJIAN	
Tracheal Wundsperrer	245	CASTROVIEJO		Knochen Splitterzange	113
BOUCHERON Ohrtrichter	198	Cyclodialysenspatel	184,185	Meißel Nasenplastik	223
Bougie, GUYON Harnröhre	271	Fixier Pinzette	192	Nasenspekulum	213
vBUREN Harnröhre	271	Hornhautscheren	33	Nasen Plastikmesser	220
BOWLES FORD Stethoskop	5	Iridektomiescheren	32	Nasenplastikmeißel	223
Stethoskop	5	Kapsel Pinzette	193	Nasenschere	23
BOWMAN Discisions Messer	180	Klingenbrecher	13	NEIVERT Haken	227
Diszissions-Nadeln	181	Lanzen Messer	180	Periost Elevatorium	222
Sperrelevator	178	Markier Instrument	185	Septum Elevatorium	222
Tränenkanalsonden	186	Nadelhalter	97	COXETER Katheter Prostata	271
BOYNTON Nadelhalter	96	Naht Pinzette	194	CRAFOORD Bronchusklemme	51
BOZEMANN DOUGLAS		Sperrelevator	179	Lungen (Thorax) Schere	27
Schwamm Zange	63	Tränenkanal Dilatator	186	Credo Ersatz Klängen	307
Nadelhalter	93	Trephe	196	Credo Hornhaut Hobel	307
Schwamm Zangen	63	CHAPUT Arterienklemme	47	CRILE Arterienklemme	45
BRAUN Dekapitations Haken	305	CHARRIERE Amputations Sägen	133	MURRAY Nadelhalter	92
Haken Zange	286	CHEATLE Sterilisierzange	105	Nadelhalter	94
Kranioklast	305	CHERON Tupferzange	62	RANKIN Arterienklemme	45
SIMPSON Geburts Zange	300	CHEVALIER JACKSON Zange	241	TITAN Arterienklemme	45
STADLER Episiotomie Schere	26	CHILDE Wundrand Faßpinzette	104	WOOD Nadelhalter	92
Uterus Depressor	289	Chirurgie Handmotor	136	Wundhaken doppelendig	65
BREISKY Spekulum	282	Chordotom, FRAZIER	170	CRITCHETT Sperrelevator	178
Bronchusklemme, CRAFOORD	51	Cilien Pinzette	197	CRUTCHFIELD Schädel Halter	167
SAROT	51	CINELLI Nasenplastikmeißel	223	Vorböhrer	167
BROWN ADSON Pinzetten	35	CITELLI Stanze	218	CULLER Iris Spatel	184



	Seite		Seite		Seite
CUSCO Spekula	276,277	DIETER Stanzen Hammerkopf	206	Druckklemme, FERGUSSON	
CUSHING Flachbohrer	134	DIETHRICH Nadelhalter	96	Angiotrib	46
Hirn Spatel	171	Dilatator, CASTROVIEJO		Drücker, ANDREW Zungen	230
Nerv Haken	168	Tränenkanal	186	HARTMANN Zungen	230
Pinzetten	35	GOODELL Uterus	285	TOBOLD Zungen	230
Wundhaken	69	HANK Uterus	285	WIEDER Zungen	230
Zange Laminektomie	172	HEGAR Uterus	283,284	DUBOIS gynäkologische Schere	25
CUZZI Abortus Löffel	304	LABORDE Tracheal	245	DUPLAY Haken Zange	286
Cystotom, BECKER	182	SIMS Uterus	285	Duplex Stethoskop	5
GRAEFE	182	TROUSSEAU Tracheal	245	DUPUY WEISS Tonsillennadel	236
CZERNY Rektal Spekulum	272	WILDER Tränenkanal	186	Dura Dissektor	169
DANDY Arterienklemme	46	WYLIE Uterus	285	Duramesser, HALLE	170
Nerven Haken	168	Augen Magnet m. Schlinge	197	DUVAL COLLIN Pinzette	36
neurochirurgische Schere	27	Excenter Verband Schere	30	Faßzängchen	260
DARLING Wundsperrerr	79	Fingerring Säge	133	Pinzette	36
Darm Scheren	28	Klingenbrecher	13	ECHLIN Hohlmeißelzange	112
DARLING Wundsperrerr	79	Klingenbrecher	13	Econom Blutdruckmesser	
Darmnadeln	103	Stimmgabeln	199	Quecksilber	1
DARTIGUES Uterusfaßzange	288	Taschenbesteck Standard	105	Econom Universal	
DASTOOR Kapsel Sauger	185	Watteträger	89	Diagnostik-Besteck	3
Strabismus Pinzette	190	Wundsperrerr	76	Ein- Ausschläger Marknägel	142
DAVIDSON Scapula-Wundhaken	75	DINGMANN Knochenhalte Zange	117	Einmal Skalpelle	12
DAVIEL Star Löffel	183	Dissektor, DAVIS Dura	169	Elektrische oszill. Gipssäge	107
DAVIS BOYLE Mundsperrerr	232	Dura	169	Elektroden	
BOYLE Spatel	232	FISCH	211	Hochfrequenzchirurgie	314,315
Dura Dissektor	169	GREEN Hornhaut	182	Elevatoren, Sperr-	178,178
Fremdkörper Nadel	181	HORSLEY Dura	170	Elevatorium, ADSON	128
Pinzette für Spritzen		HURD Tonsillen	235	BALLENGER Septum	222
und Kanülen	105	LANG Tränensack-, und Löffel	184	COTTLE Periost	222
DAY Ohr Häkchen	203	MILLIGAN Dura	169	COTTLE Septum	222
DE BAKEY Nadelhalter	93	PATON	181	FREER Septum	221
de LEE Geburts Zange	300	PENFIELD	170	HAJEK BALLENGER Septum	222
De MARTEL		SACHS Dura	169	HENKE Tonsillen	235
Umführungsinstrument	169	TOENNIS Dura	169	JOSEPH Periost	222
DEAN Iris Messer	180	DIX Fremdkörper-Meißel,		KEY	128
Tonsillenscheren	23	-nadeln	182,185	KILLIAN Septum	222
DEAVER Grip Wundhaken	67	Doppelelevatorium, McDONALD	129	LANGENBECK	128
Scheren	19	MURPHY LANE	129	LEMPERT	211
Wundhaken	67	WATSON CHEYNE	129	McKENTY Septum	221
DEBAKEY Atrauma Pinzette	40	Doppelhäkchen, GUTHRIE	68	ROGER Septum	221
Bulldog Klemme Atrauma	41	Doppellöffel, MARTINI scharf	120	ELLIOT Geburts Zange	300
Gefäß-Schere	24	VOLKMANN scharf	120	Trephinen	197
Gefäß/Thorax-Schere	24	WILLIGER scharf	120	ELLIS Fremdkörper Hohlmeißel	182
DEJERINE Hämmerr	6	Doppelraspatorium, OVERHOLT	128	ELSCHNIG Cyclodialyse Spatel	184
DeMARTEL WOLFSON		Dose, Nadel rund	308	Fixier Pinzette	192
Anastomosenklemme	264	DOUGLAS BOZEMANN		Hornhaut Messer	181
DeMARTEL WOLFSON		Schwamm Zange	63	Kapsel Pinzette	193
Klemmenhalter	264	Cilien Pinzette	197	EMMET Fistel Haken	296
DeMARTEL WOLFSON		Trokarkanüle	90	ENGEL Gips Säge	106
Schließzange	264	DOYEN Baby Darm Klemmen	260	Enukleations Scheren	22
DENHART Mundsperrerr	231	Bauchdeckenhaken	74	EPPENDORFER Biopsie Zange	295
Depressor, BRAUN Uterus-	289	Darm Klemmen	260	KEVORKIAN	296
SIMS Uterus-	289	Fräser	137	TISCHLER MORGAN	296
DERF Nadelhalter	92	gynäkologische Schere	25	Ersatz Lampe Laryngoskop	9
DESCHAMPS Nadeln	98	Hohlsonde	88	Ersatznadel, YOUNG	99
DESJARDINS Gallensteinlöffel	257	JANSEN (MOLT) Mundsperrerr	231	ESMARCH Gips Messer	108
Gallensteinsonde	257	Kugel Fräser	137	Verband Schere	30
Gallensteinzange	256	Myom Heber	296	EVES Tonsillenschnürer	237
Gallenkanal Klemmzange	54	Rippenraspatorien	127	Extensionsbügel	140
Gallenkanal Klemme	54	Spekulum	281	Extraktions Haken	143
DESMARRES Chalazion Pinzette	195	Tuchklemme mit Ring	59	Extraktor, KUENTSCHER	143
Wundhaken/Lidhalter	69	Uterus Polypenzange	288	Faden Stanze	244
DEUTSCHMANN Star Messer	179	Draht, KIRSCHNER	139	FARABEUF Knochen Haltezange	114
DeVILBISS Schädelzange	169	Draht- Schneide- u. Biegezange	141	LAMBOTTE	
DEWEY Geburtszange	302	Drahtschere, Universal	29	Knochen Haltezange	115
Diamant Drahtschneider	142	Drahtschneider, Diamant	142	Raspatorium	126
DIEFFENBACH Gefäßklemme	42	Drahtspanner, LOUTE	141	Wundhaken doppelt	64

	Seite		Seite		Seite
FARREL Watteträger	89	FOX Lupus Kürette	306	Gips Schere	30
FAULKNER Kürette scharf	228	FRAENKEL		Gips Spreizer	108
FAURE Biopsie Zange Uterus	291	Kehlkopf Polypenzange	239	Gipssäge, elektrisch, oszillierend	107
Peritoneum Klemmen	56	Zangen Aufsatz	240	Glasschale	309
Faßpinzette, CHILDE Wundrand	104	Fräser	134	GLOVER Gefäß Klemme Atrauma	41
Faßzange, LAHEY Kropf	247	Fräser, ALBEE	137	GLUCK Rippen Schere	248
LOVELACE Lungen	254	BORCHARDT olivf	137	GOELET Wundhaken doppelt	65
MARTIN Knorpel	117	DOYEN	137	GOLDSTEIN Sperrelevator	179
MILLIN Kapsel	267	Kortikalis	145	GOOD Tonsillenschere	23
MILLIN Lappen	267	TOTI	137	GOODELL Uterus Dilatator	285
Universal	105	Fragment-Platte, Kompression	163	GOSSET Bauchdeckenhalter	83
YOUNG Prostata	267	Platte Mini Kompression	163	GRADLE Cilien Pinzette	197
Federhäkchen	68	FRANCESCETTI Trephinen	196	GRAEFE Cystotome	182
FEHLAND Darm Klemme	263	FRANCIS Fremdkörper Nadel	181	Fixier Pinzetten	192
FEILCHENFELD Splitterpinzette	38	FRANKE Blutschnäpper	2	Häkchen (Iris)	68
Feile, JOSEPH Knochen-	224	FRANKLIN SILVERMANN Nadel	91	Iris Pinzetten	186,187
Nagel-	307	FRAZIER Chordotom	170	Pinzette	35
FERGUSSON		Häkchen (Dura) scharf	68	Schiel Haken	182
Angiotrib Druckklemme	46	Punktionskanüle	171	Skarifikateur	180
Gallen Stein Löffel	257	Saug Kanüle	171	Sperrelevator	178
Knochen Haltezange	114	Wundspreizer	83	Star Löffel	183
FERRIS SMITH KERRISON		FREEER Hohlmeißel	224	Star Messer	179
Stanzen	174	Mukosa Messer	220	TITAN Schiel Haken	182
FERRIS SMITH Pinzette	36	Septum Elevatorien	221	GRAHAM Nerv Haken stumpf	168
SMITH Zange Laminektomie	173	Septum Meißel	222	GRAVE Spekulum	276
Fertigschläger, KUENTSCHER	143	Septum Messer	220	Spekulum Laser Modell	276
Finger, KNOWLES Verband Schere	30	Fremdkörper Zange	244	GRAY Gallenkanal Klemmen	54
LANGENBECK Schützer	234	Fremdkörper Nadeln	181	GREEN ARMYTAGE	
Platten	162,163	FRENZEL Zungen Spatel	230	Klemm Zange	303
Fingernagel Bohrer	133	FRIEDMAN Hohlmeißel Zangen	109	Fixier Pinzette	192
Fingerring Säge	133	Mini Hohlmeißelzange	109	Hornhaut Dissektor	182
FINOCHIETTO ALU		Wundsperrerr Perineorrhaphie	282	Muskel Haken	182
Infant Rippensperrerr	250	FRITSCH Wundhaken	73	SENN Wundhaken	69
ALU Rippensperrerr	250	FRYKHOLM Hohlmeißelzange	112	Wundhaken	72
BURFORD ALU Rippensperrerr	251	FUCHS Kapsel Pinzette	193	GREVEN Zängchen Drahtbiege-	206
BURFORD Rippensperrerr	251	Führungshohlsonde, BRUNNER	100	Griff für Kehlkopfspiegel	241
FINOCHIETTO Baby Sperrerr	250	KIRSCHNER	100	GIGLI für Drahtsäge	169
Bronchus Klemme	254	KOENIG	100	HUBER Universal	240
Nadelhalter	94	PAYR	100	Grip-Zange	141
Wundsperrerr	250	SCHMIEDEN	100	GROSS MAIER Kornzange	60
FINSEN Wundsperrerr	76	Führungsspieß	143	Ohröffel u. Haken	202
FISCH Dissektoren	211	GALLAHER Antrum Raspeln	226	GRUBER Ohntrichter	198
FISCHER Iris Pinzette	189	Garnitur, Schwestern	307	GUTHRIE Doppelhäkchen	68
Flachbohrer, CUSHING	134	GAUSS Kopfschwarten Zange	303	GUTMANN Sekret Löffel	270
Flachfräser	137	Gefäß Stripper	89	GUYON Dilatationsbesteck	270
Flachmeißel	121	Gefäß/Coronar-Schere	23	Harnröhrenbougie	271
Flachmeißel, ALEXANDER	121	Gefäßklemme, DIEFFENBACH	42	Katheter Spanner	270
DIX Fremdkörper	182	JOHNS HOPKINS	42	MAYO Nierenstielklemme	55
DIX Fremdkörper, mit Nadel	185	Gegensperrerr, CASPAR	80,82	Nierenstielklemme	55
HIBBS	123	GELLHORN Biopsie Zange	292	GUYTON LUNDSSGAARD	
HOKE	123	GELPI Perineal Wundsperrerr	86	Sklerotom	181
LEXER	123	Gemini Präparier-		HABERER Spatel biegsam	66
PARTSCH	121	und Ligaturklemme	49	Häkchen	211
SMITH PETERSEN	122	GERALD Pinzetten	37	Häkchen, BARBARA	210
STILLE	121	GERSTER Distraktions Klammer	118	BOSE Tracheal	245
Flachzange	141	GERZOG Hammer	125	DAY Ohr	203
FLEURANT Trokar f. Blasenstich	90	Gewebe Schutzhülse	145	FRAZIER (Dura) scharf	68
FOERSTER Iris Pinzetten	188	Gewinde Bohrer	145	GILLIES fein	227
Schwamm Zangen	61	GIERTZ STILLE Rippenschere	249	GRAEFE (Iris)	68
FOMON Choanen Haken	227	GIGLI Griff für Drahtsäge	169	ITERSON Tracheal	245
Meißel	223	GILL ARRUGA Kapsel Pinzette	192	JACKSON Tracheal	245
Nasen Raspeln	225	HESS Iris Pinzette	188	KILNER Haut	306
Nasenflügel Haken	227	Hornhaut Messer	181	KNAPP	182
Nasenschere	22	Iris Pinzette	188	McGEE	211
FORD BOWLES Stethoskop	5	GILLIES Häkchen fein	227	O'CONNOR Iris scharf	182
Stethoskop	5	Nadelhalter m. Schere	95	ROLLET	182
FOREGGER Laryngoskope	9	Pinzette	37		

	Seite		Seite		Seite
ROSE Tracheal, doppelendig	246	BERLINER	6	Hirmmesser mit Hohlheft	16
WAGENER Knopf	203	Hammer bleigefüllt	125	HIRSCHMANN Anuskop	274
WIENER Iris	182	BUCK	6	Hobel, Credo Hornhaut	307
HAGLUND STILLE Gips Spreizer	108	COLLIN	125	HOESEL Nadelhalter	95
HAIGHT Rippensperrer	252	DEJERINE	6	HOFER Gaumenbogen Haken	235
HAJEK BALLENGER		GERZOG	125	Hohlmeißel	121
Septum Elevatorium	222	KIRK	125	Hohlmeißel, ALEXANDER	121
CLAUS Kieferhöhlenstanze	218	Hammer Kunststoff	125	DIX, und Nadel	185
Hohlmeißel V-Form	224	LUCAE	125	ELLIS Fremdkörper	182
KOFLER Stanze	218	Hammer mit Hakengriff	125	FREER	224
Haken, ADSON Dura	168	QUISLING intranasal	125	HAJEK V-Form	224
ARRUGA Extraktion	182	TAYLOR	6	HIBBS	123
AUFRICHT Nasenrücken	227	TRAUBE	6	KILLIAN CLAUS	224
BLOUNT Knie	131	TROEMNER	6	LEXER	123
BRAUN Dekapitations	305	WILLIGER	125	LEXER mini	123
CASPAR	81	Handbohrapparate	134-136	PARTSCH	121
COTTLE	227	Handgriff f. Gefäß Stripper	89	SMITH PETERSEN	122
COTTLE NEIVERT	227	Handgriff mit Jacobs-Futter	136	STILLE	121
CUSHING Nerven	168	Handmotor, Chirurgie	136	WALTON Fremdkörper	182
DANDY Nerven	168	HANK Uterus Dilatoren	285	WEST Nasen	224
EMMET Fistel	296	HARRINGTON Bronchusklemme	254	Hohlmeißelzange, ADSON	110
Extraktions	143	Wundhaken	67	BEYER	111
FOMON Choanen	227	HARTMANN Arterienklemme	42	BLUMENTHAL	109
FOMON Nasenflügel	227	COLLIN Wundhaken Draht	65	BÖHLER	111
GRAEFE Schiel	182	HALLE Spekulum	212	CLEVELAND	109
GRAEFE TITAN Schiel	182	HOFFMANN Ohrzängchen	204	ECHLIN	112
GRAHAM Nerv	168	Nasen Zange scharf	217	FRIEDMAN	109
GREEN Muskel	182	Nasenpolypen Zange	214	FRYKHOLM	112
GROSS und Ohrlöffel	202	Ohr Katheter	202	LEKSELL (STILLE)	112
HOFER Gaumenbogen	235	Ohrzängchen	204	LEMPERT	110
JAMESON Schiel	182	Ohrtrichter	198	LUER	110
Nagel	146	Stimmgabeln	199	MEAD	109
NAGER Gaumensegel	235	WULLSTEIN Ohrzängchen	204	OLIVECRONA	110
PRATT Cystikus	274	Zungen Drücker	230	RUSKIN	111
SACHS Nerv	168	HAUGH Ohrzängchen	206	SEMB	113
SCHOENBORN Schilddrüsen	247	Haut Schere	307	STILLE LUER	111
SMELLIE Geburts	303	HEANEY Hysterektomie Klemme	57	STILLE RUSKIN	112
SMITHWICK Nerv	168	Nadelhalter	93	ZAUFAL JANSEN	111
STEVENS Linsen	182	Wundhaken	74	Hohlschrauben	152
TAYLOR Spinal	131	HEATH Ligatur Schere	28	Hohlschraube,	
YOUNG Prostata	267	RICHTER		Schraubendreher für	145
HALLE Dura Messer	170	Wundklammern Zange	104	Hohlsonden	88
HARTMANN Spekulum	212	Hebel, BUCK Fremdkörper	204	Hohlsonde, DOYEN	88
scharfer Löffel biegsam	120	QUIRE Fremdkörper	204	HOHMANN Knochenheber	129,130
TIECK Nasenspekulum	213	HEBRA Chalazion Löffel	183	mini Knochenheber	130
HALSEY Nadelhalter	92	HEGAR Dilatoren	283,284	HOKE Flachmeißel	123
HALSTED micro Mosquito Klemme	43	MAYO Nadelhalter	92	HOLTH Kapsel Stanze	185
Mosquito Klemme	43	OLSEN Nadelhalter	95	HOPKINS Gips Messer	108
TITAN Mosquito Klemme	43	Uterus Dilator	283	JOHNS	
Halsweichteilsperrer, CASPAR	80	HEGENBARTH		Arterien/Gallenkanalklemme	53
Halter, CRUTCHFIELD Schädel	167	Wundklammerpinzette	104	JOHNS Gefäßklemme	42
KALLMORGEN, Scheiden	280	HEIFETZ Hirn Spatel biegsam	171	HORSLEY Dura Dissektor	170
KALLMORGEN, und Spekulum	280	HEISS Arterienklemmen	48	STILLE Knochen Splitterzange	114
KRISTELLER, Scheiden	278-280	HEISTER Mundsperrer	231	HOUSE Kürette	211
Lippen und Wangen	231	HENKE Tonsillen Elevatorium	235	HUBER Universal Griff	240
REICHERT Kehldeckel	239	HENNIG Gips Spreizer	108	HUDSON Bohrwinde komplett	134
STERNBERG Lippen	230	HERRICK Nierenstielklemme	56	Hüftschraube dynamisch	151
Wangen Simplex	231	HESS GILL Iris Pinzette	188	HUNTER Splitterpinzette	38
Haltezange, FARABEUF Knochen	114	Kapsel Pinzette	193	HURD Tonsillen-Dissektor	235
FERGUSON Knochen	114	HEYMANN KNIGHT Nasenzange	215	INGE Spreizer Wirbelkörper	171
LANE Knochenplatten	144	Nasenzange scharf	215	Innendose zu Nadeldose	308
LANE Knochenschrauben	144	Nasenschere	22	Instrumenten Schale	310
LANGENBECK Knochen	114	HEYWOOD SMITH		Inzisionsschere	19
SEMB Knochen	114	Hämorrhoiden Zange	275	IOWA Haken Zange	287
Hamburg Knopf Kanüle	196	HIBBS Flachmeißel	123	Iris, Bonn Pinzette	190,191
Hammer	125	Hohlmeißel	123	DEAN Messer	180
Hammer, BABINSKY	6	Osteotom	123	GILL Pinzette	188

	Seite		Seite		Seite
HESS Pinzette	188	LICHTWITZ Kieferhöhle	219	COLLIN Nabelschnur	303
KNAPP Messer	180	LUER Tracheal	246	DEBAKEY Bulldog Atrauma	41
Iris Schere	21	SCHEIE Augen	196	DeMARTEL WOLFSON	
ZIEGLER Messer	180	SIMCOE Naht	196	Anastomosen	264
ISRAEL Wundhaken	73	Tonsillen	238	DESJARDINS Gallenkanal	54
ITARD Ohr Katheter	202	Tübingen Luft	196	DOYEN Baby Darm	260
ITERSON Tracheal Häkchen	245	Kanüle z. Lumbalpunktion	91	DOYEN Darm atraumatisch	260
IVES FANSLER Anuskop	274	Kanüle z. Pudendus Anaesthesie	91	DOYEN Darm	260
JACKSON CHEVALIER Zange	241	Kassette,		FAURE Peritoneum	56
Spekulum	281	Nadel m. Teilung gelocht	308	FEHLAND Darm	263
Tampon Pinzette	239	Katheter, COXETER Prostata	271	FINOCHIETTO Bronchus	254
Tracheal-Kanülen	246	HARTMANN Ohr	202	Gemini mini Präparier-/Ligatur	49
Tracheal-Häkchen	245	ITARD Ohr	202	Gemini Präparier-/Ligatur	49
Jacobs Dreiecken Spannhalter	136	MAGILL Einführzange	8	GLOVER Gefäß Atrauma	41
JACOBS Haken Zange	287	Katheter Metall Frauen	271	GRAY Gallenkanal	54
JAEGER Lanzen Messer	180	Katheter Metall Männer	271	HALSTED micro Mosquito	43
Lid Platte	179	Kehlkopf-Spiegel	241	HALSTED Mosquito	43
JAMESON Schiel Haken	182	Keil, MAUNDER Mund aus Holz	234	HALSTED TITAN Mosquito	43
Strabismus Pinzetten	189	PITHA Mund Silikongummi	234	HARRINGTON Bronchus	254
JAMISON Nadelhalter	93	KEITH Nähnaht	103	HEANEY Hysterektomie	57
JANSEN DOYEN (MOLT)		KELLY Arterienklemme	45	JOHNS HOPKINS	
Mundsperrer	231	Grip Wundhaken	66	Arterien/Gallenkanal	53
MIDDLETON Zange scharf	219	gynäk. (Fistel) Schere	25	KANE Nabelschnur	303
Nasenpinzette	214	Proktoskop	274	KOCHER Darm	261
Wundsperrer	76	RANKIN Arterienklemme	45	KOCHER Darm atraumatisch	261
ZAUFAL Hohlmeißel Zange	111	TITAN Arterienklemme	45	LAHEY Bronchus	254
JARCHO Haken Zange	286	Uterus Polypenzange	288	LAHEY Gallenkanal	53
JATHO		Wundhaken	66,74	LANE Magen	265
Nasenrachen Zange scharf	228	KERN Knochenhalte Zangen	115	LAWRENCE Arterien/Präparier	52
JENNINGS Mundsperrer	232	KERRISON Stanze	218	LOWER Gallenkanal	53
JEWETT Nagel	150	KEVORKIAN Aufsatz	296	LURZ Ureter	258
JOBSON HORNE Watteträger	89	Biopsie Zange	293	MASTIN Muskel	247
JOHNS HOPKINS		EPPENDORFER	296	MAYO ROBSON Darm	262
Arterien/Gallenkanal	53	Kürette mit Korb	290	MAYO ROBSON	
HOPKINS Gefäßklemme	42	Pacific Biopsie Stanze	294	Darm atraumatisch	262
JOHNSON Nadelhalter	94	TISCHLER Aufsatz	294	MEEKER	
JONES Tuchklemmen	59	TISCHLER Stanzen	295	Arterien/Präparier/Ligatur	52
JOSEPH (LEWIS) Nasen Raspel	225	TOWNSEND Stanze drehbar	294	MIKULICZ Peritoneum	56
Knochen Felle	224	Uterus-Biopsie-Kürette	290	MIXTER Arterien	53
Nasen Sägen	227	KEY Elevatorium	128	MIXTER Gallenkanal	54
Nasenplastik-Messer	220	KEYES Haut Stanzbesteck	306	MIXTER O'SHAUGNESSY	53
Periost Elevatorium	222	Haut Trephine	306	NEGUS Tonsillen	236
Schere	21	KIELLAND Geburts Zange	300	PAYR Baby Quetsch	266
Schleimhauthäkchen	68	KIELLAND LUIKART		PAYR Quetsch	266
Skalpell Nase	220	Geburts Zange	301	PHANEUF Peritoneum	56
JUDD ALLIS Zange	259	KILLIAN CLAUS Hohlimeißel	224	PRICE THOMAS Bronchus	254
MASSON		Septum Elevatorium	222	SAROT Bronchus	255
Blasen u. Wundsperrer	268	Septum Spekulum	213	SATINSKY Anastomosen	255
JUERS Zängchen Drahtbiege	206	Spül Kanüle	219	SAWTELL Tonsillen	236
JURASZ Kehlkopf Polypenzange	239	KILNER DOUGHTY Mundsperrer	233	Schlauch	58
KABIERSKE Pulverbläser	200,201	DOUGHTY Zungendrucker	233	SCHNIDT Tonsillen	236
KALLMORGEN Scheidenhalter	280	Haut Häkchen	306	SEMB Bronchus	255
Scheidenspekulum	280	Schere	21	STOCKMANN Penis	270
Spekulum u. Halter	280	KIRBY ARTHUR Iris Pinzette	189	STONE Verschuß	263
KALT ARRUGA Nadelhalter	97	KIRK Hammer	125	STONE WATT Darm	263
Kapsel Pinzette	193	KIRSCHNER Bauchdeckenhalter	85	STRAUSS Penis	270
Nadelhalter	97	Bohrapparat mit		WERTHEIM CULLEN	
KANE Nabelschnur Klemme	303	Bohrdrahtstütze	135	Hysterektomie	57
Kanülen, Bonn Spül	196	Draht	139	WERTHEIM Hysterektomie	57
BUIE Saug	275	Extensionsbügel	140	ZENKER Präparier/Ligatur	51
DAVIS Pinzette f.		Führungshohlsonde	100	Klemmenhalter,	
Spritzen und Kanülen	105	Klammer, GERSTER Distraktions	118	DeMARTEL WOLFSON	264
FRAZIER Punktion graduert	171	RANEY Kopfhaut	167	Klemmzange, MOYNIHAN	54
FRAZIER Saug	171	Klammerblock f. Gehirnaht	166	Klingen, Credo Ersatz f.	
Hamburg Knopf	196	Klemme, BEST Darm	263	Hornhautho	307
JACKSON Tracheal	246	BRUNNER Darm	263	Klingenbrecher, CASTROVIEJO	13
KILLIAN Spül	219	BRYANT Tupfer	62	TROUTMAN CHRIS	13

	Seite		Seite		Seite
KLINKENBERGH		KUENTSCHER Aufreiber Femur	143	für HF-Chirurgie	315
LOTH Thoraxschere	27	Extraktor	143	Laryngoskop, Ersatz Lampe	9
KNAPP Häkchen	182	Fertigschläger	143	FOREGGER	9
Iris Messer	180	Marknagel	147	McINTOSH	9
LUER Trachom Pinzette	195	Nagel Unterschenkel	148	LAWRENCE Arterien- und Präparierklemme	52
Star Löffel	183	Vorböhrer	143	Lebensretter, WAGENER MOSHER	246
Kneifzange doppelt übersetzt	142	Vorschlaginstrument	143	LEBSCHKE Sternummeißel	124
KNIGHT HEYMANN Nasenzange	215	Kürette, ALVIS Fremdkörper	182	LEGUEU Blasen Spatel	268
Nasenzange scharf	215	BLAKE doppelt scharf/stumpf	297	Blasen- u. Wundspreizer	269
Knochen, COTTLE KAZANJIAN		BUCK Ohr	201	LEKSELL(STILLE)	
Splitter-	113	BUMM Uterus	299	Hohlmeißelzangen	112
FARABEUF LAMBOTTE		COAKLEY Antrum	228	LEMPERT Elevatorium	211
Halte Zange	115	FAULKNER scharf	228	Hohlmeißelzange	110
Knochen Raspel/Feile	132	FOX Lupus	306	Löffel scharf	120
STILLE HORSLEY Splitter-	114	HOUSE	211	LERCHE Pinzette	36
Knochendraht	141	KEVORKIAN Uterus-Biopsie	290	LERICHE Arterienklemme	48
Knochenhalte Zangen	116,117	NOVAK Saug	290	LESTER Fixier Pinzette	192
Knochenhebel	130	PESTALOZZA Abortus	304	LEVINSON Fremdkörper Nadel	181
Knochenhebel, BENNETT	129	PIFFARD Lupus	306	LEWIN Knochenhalte Zange	117
BLOUNT	131	RANDALL Saug	290	LEXER Baby Scheren	20
HOHMANN	129,130	RECAMIER Uterus	299	Flachmeißel	123
Knochnagel, STEINMANN	139	SIMS Uterus	299	Hohlmeißel	123
Knopf Sonde	88	Kugelelektrode zur Koagulation	315	Scheren	20
Knopf Sonde mit Ohr	88	KUHNT Hornhaut Schaber	181	LICHTWITZ Kieferhöhlen-Kanüle	219
Knorpelschere, McINDOE	27	LABORDE Tracheal Dilatator	245	Trokar Kieferhöhle	90
KNOWLES Verband Schere Finger	30	Lärmtrommel, BARANY	200	Ligaturschere, LITTAUER	28
Koagulation, Elektroden		LAFORCE Adenotom	229	Lippen und Wangen Halter	231
HF-Chirurgie	314,315	Ersatz Messer	229	LISTER (Sinus) Tupfer Zange	62
KOCHER Arterienklemme grazil	45	Fremdkörper Instrument	182	BURCH Sperrelevator	178
Blasen Spatel	268	LAHEY Bronchus Klemme	254	Verband Scheren	30
Darm Klemme	261	Gallenkanal Klemme	53	LISTON Amputations Messer	15
Darm Klemme atraumatisch	261	Kropf Faßzange	247	Knochensplitterzange	113
Kropf Sonden	247	Wundhaken	70	RUSKIN Knochensplitterzange	113
Wundhaken	72,73	LAMBERT Chalazion Pinzette	195	STILLE Knochensplitterzange	113
KOENIG Führungshohlsonde	100	LOWMAN		LITTAUER Cilien Pinzette	197
Nähnadel Angelhaken	103	Knochen Halteklammer	118	Ligaturschere	28
ROSER Mundsperrerr	231	LAMBOTTE FARABEUF		Nasen Polypenzange	215
KOERTE Wundhaken	73	Knochenhalte Zange	115	Ohr Zängchen	204
KOGAN Endo Spekulum	282	Knochenhalte Zange	115	LITTLE Wundhaken	70
Kombination Diagnostik Besteck	3	Osteotome	122	LLOYD Vorschläger /Nagelzieher	144
Kompression, Platte breit	158	Raspatorium	126	Löffel, AXENFELD Chalazion	183
Platte schmal	157	Laminektomie, WAGNER Zange	173	BRUNS scharf	119
Schraube	151	Lampe f. Clar Stirnlampe	4	BUNGE Exenterations	183
Kompressorium,		LANCASTER Sperrelevator	179	CUZZI Abortus	304
CORWIN Tonsillen	237	LANDAU Spekulum	282	DAVIEL Star	183
Komprimierer für Blutleere	132	LANE Biegehebel		DESJARDINS Gallenstein	257
Kondylen Platte	159,160	f. Knochenplatten	144	FERGUSSON Gallenstein	257
KONRICH Sterilisier-Trommel	311	Haltezange für Knochenplatten	144	GRAEFE Star	183
Kontraktor, BAILEY Baby, Rippen-	253	Haltezange für		GUTMANN Sekret	270
BAILEY GIBBON, Rippen-	253	Knochenschrauben	144	HEBRA Chalazion	183
BAILEY Rippen	253	Knochenhalte Zangen	115	KNAPP Star	183
Rippen	253	Magen Klemmen	265	MAYO Gallenstein	257
Kopfhautklemme, MARTEL	47	MURPHY Doppelelevatorium	129	MEYHOEFER Chalazion	183
WILLET MARTEL	47	Pinzette	36	MOORE Gallenstein	256
Kornzange, GROSS MAIER	60	Schraubendreher	144	SCHEDE scharf	119
Kortikalis Fräser	145	Tuchklemme	59	SELLHEIM Geburts-	305
Kortikalis Schrauben	153,154	LANG Tränensack Löffel		SIMON scharf	120,297
Kranioklast, BRAUN	305	und Dissektor	184	SPRATT scharf	119
TARNIER	305	LANGE Zangen Aufsatz	240	VOLKMANN scharf	119
KRAUSE Nasen Schnürer	219	LANGENBECK Elevatorium	128	WALLICH Abortus	304
Schnürer Ohrpolypen	203	Finger Säge	133	WELLS Eukleation	184
Zangen Aufsätze	240	Finger Schützer	234	Lösungs Schale	309
Kreissäge Blatt allein	138	Knochen Haltezange	114	LORNA Tuchklemme	59
Kreissäge doppelt und einfach	138	Raspatorium	126	LOUTE Drahtspanner	141
KRISTELLER Scheidenhalter	278,279	Resektions Messer	15		
Spekulum	278-278	Wundhaken	71		
KRONECKER Nadel	98	Lanzettelektroden			



	Seite		Seite		Seite
LOVE GRUENWALD		Nieren Stein Sonde	258	MIKULICZ Peritoneum Klemme	56
Zange Laminektomie	172	NOBLE Scheren	19	Wundhaken	74
Nerv Wurzelhaken	168	ROBSON Darm Klemmen	262	MILLIGAN Dura Dissektor	169
Zäpfchen Retraktor	235	Scheren	19	MILLIN Blasenhalsh Wundsperrerr	269
LOVELACE Arterienklemme	46	Sterilisierklemmer	105	Faden Führungs Zange	267
Lungen Faßzange	254	STILLE Scheren	19	Faßzange vordere Lappen	267
LOWER Gallenkanal Klemme	53	McCULLOUGH		Kapsel Faßzangen	267
LOWMAN Knochen Halteklemmer	118	Strabismus Pinzetten	189	Mini-Platte gerade	162
LAMBERT Knochen		McDONALD Doppelelevatorium	129	Schraube Kreuzschlitz	153
Halteklemmer	118	McGEE Häkchen	211	Miniclip, YASARGIL	176
LUBET BARBON		McGEE Zängchen Drahtbiege	206	MIXTER Arterien-Klemmen	52,53
Nasenpolypenzange	215	McGUIRE Hornhaut Schere	32	Baby Arterienklemme	52
LUC Nasen Zange scharf	216	McINDOE Knorpelschere	27	Gallenstein Zange	256
LUCAE Hammer	125	McINDOE Pinzette	36	Gallenkanal Klemme	54
Ohrpinzette	203	McINTOSH Laryngoskope	8,9	O'SHAUGNESSY Klemme	53
Stimmgabel	200	McIVOR Mundsperrerr	233	MOELTGEN Winkelmesser	7
LUER Hohlmeißelzange	110	McKENTY Septum Elevatorium	221	MOLLISON Wundsperrerr	79
KNAPP Trachom Pinzette	195	McKENZIE Bohrer	134	MOORE Bohraparat	134
STILLE Hohlmeißel Zange	111	McKENZIE Clip-Anlegezange	166	Gallenstein Löffel	256
Tracheal Kanüle	246	McLAUGHLIN Platte	149	STAUDE Haken Zange	286
LUIKART BILL Zughebel	302	McLEAN Geburts Zange	301	MOORFIELD Naht Pinzette	194
Geburts Zange	301	McLEAN LUIKART Geburts Zange	301	MOYNIHAN Gallenstein Sonde	257
KIELLAND Geburts Zange	301	McLEAN TUCKER Geburts Zange	301	Klemmzange	54
McLEAN Geburts Zange	301	McLEAN TUCKER LUIKART		Tuchklemme	59
SIMPSON Geburts Zange	301	Geburts Zange	301	MUCK Messer Periost	211
Lumbalpunktions-Kanüle	91	McPHERSON Faden Pinzetten	194	MUELLER Sperrelevator	179
LUNDSGAARD GUYTON		MEAD Hammer	125	Mund Spatel Holz	230
Sklerotom	181	Hohlmeißelzangen	109	Mundsperrerr, DAVIS BOYLE	232
Sklerotom	181	MEEKER Arterien/Präparier/		DENHART	231
LUNIATSCHEK Tampon Stopfer	235	Ligatur-Klemmen	52	DOYEN JANSEN (MOLT)	231
LURZ Ureter Klemmen	258	Meißel, BRUNETTI Wirbelsäule	124	HEISTER	231
MAGILL Katheter Einführzange	8	CINELLI Nasenplastik	223	JENNINGS	232
MAISONNEUVE Urethrotom	269	COTTLE Nasenplastik	223	KILNER DOUGHTY	233
Malleolar-Hohlschrauben	152	FOMON	223	McIVOR	233
Schrauben	154	FREER Septum	222	ROSER KOENIG	231
MALTZ (COTTLE) Nasen Raspel	225	PASSOW Blutstillung	211	SEEMANN SEIFFERT	232
Marknägel, Vorbohrer für	142	ROLLET Extirpations	182	WHITEHEAD	232
Marknagel, KUENTSCHER	147,148	SILVER Nasenplastik	224	MURDOCK Sperrelevator	178
MARSCHIK Tonsillenpinzette	237	WEST Nasen	224	MURPHY LANE	
MARTEL De Umführungs-		MELLINGER AXENFELD		Doppelelevatorium	129
Instrument	169	Sperrelevator	178	MUSEUX Haken Zange	287
Kopfhautklemme	47	Sperrelevator	178	Muskelabspreizer, CASPAR	82
WILLET Kopfhautklemme	47	MENGHINI Nadel	91	Muskelhaken	87
MARTIN Becken Zirkel	303	Saugspritze	91	Mutter f. Kortikalis- u.	
Knorpel Faßzange	117	Trokar für 2. Einstich	91	Malleolarschrauben	154
Naht Pinzette (St. Martin)	194	Meniskotom, BIRCHER	131	Mutterschlüssel	
Uterus-Sonden	289	NEFF	131	f. Extensionsbügel	140
MARTINI Doppellöffel scharf	120	SMILLIE	131	MYLES Nasen Zange scharf	217
Maßstäbe	7	MERCEDES Thorax Wundsperrerr	253	Myom, DOYEN Heber	296
MASSON JUDD		Messer, LAFORCE Ersatz	229	SEGOND Messer	296
Blasen u. Wundsperrerr	268	METZENBAUM fino Schere	20	Myrtenblatt Sonde	88
Nadelhalter	93	Nadelhalter	94	NABATOFF Varizen-Besteck	88
MASTIN Muskel Klemme	247	Scheren	20,21	Nabelschnur Schere US Modell	26
MATHIEU Fremdkörper Zange	269	MEYERDING Wundhaken	70	Nadeln, BARBARA	210
Nadelhalter	95	MEYHOEFER Chalazions Löffel	183	BOWMAN Diszissions	181
Rektal Spekulum	272	Meßbecher graduiert	310	COOPER	98
Wundhaken doppelt Paar	65	Meßzirkel, BERTILLON	7	DAVIS Fremdkörper	181
MATSON ALEXANDER		MICHEL Spiegel	214	DESCHAMPS	98
Raspatorium	128	Wundklammern	104	Nadel Dose rund	308
Raspatorium	128	Wundklammerpinzette	104	DUPUY WEISS Tonsillen	236
MAUNDER Mund Keil aus Holz	234	Zängchen zum Anlegen/		Elektroden	314,315
MAY Ophthalmoskop	2	Abnehmen d. Wundkl	104	FRANCIS Fremdkörper	181
MAYO (HARRINGTON) Schere	19	Micro Pinzette	39	FRANKLIN SILVERMANN	91
BLAKE Gallenstein Zangen	256	Micro Schere	33	Fremdkörper	181
Gallenstein Löffel	257	MIDDELDORPF Wundhaken	72	Nadel Kassetten	308
GUYON Nierenstielklemme	55	MIDDLETON JANSEN		KRONECKER Unterbindung	98
HEGAR Nadelhalter	92	Zange scharf	219	LEVINSON Fremdkörper	181

	Seite		Seite		Seite
MENGHINI Leberpunktion	91	Unterbindungs Nadel	98	ROCHESTER Arterienklemme	45
NELSON Unterbindung	98	Nerv Präparier- Schere	26	PEDERSON Scheiden Spekulum	276
POLITZER Paracentese	202	Nierenschale	309	PEET Splitterzängchen	38
REVERDIN	99	Nierenstiellklemme, GUYON	55	PELKMANN Tupferzange	62
ROSEN	210,211	HERRICK	56	PENFIELD Dissektoren	170
Star gebogen	181	MAYO GUYON	55	PENNINGTON Arterienklemme	46
VERRES Pneumoperitoneum	91	STILLE	55	PERCY Retraktor f. Amputation	133
Nadelhalter, ADSON	94	NORTHBENT (SPENCER)		Perforatorium, SMELLIE	305
ARRUGA	96	Ligatur Schere	28	PERTHES Pfriem	138
BARRAQUER	97	NOTO Uterus Polypen Zange	288	PESTALOZZA Abortus Kürette	304
BAUMGARTNER	92	NOVAK Saug Kürette	290	Petri Schale m. Deckel	310
BOYNTON	96	NOYES Iris Schere	32	Pflasterspatel	89
BOZEMANN	93	Nasen Polypen Zange	215	Pfriem	138
CASTROVIEJO	97	O'CONNOR Iris Häkchen	182	Pfriem, PERTHES	138
COLLIER	92	O'SULLIVAN O'CONNOR		PHANEUF Peritoneum Klemme	56
CRILE	94	Bauchdeckenhalter	83	Pick	211
CRILE MURRAY	92	OCHSNER Gallenstein Sonde	256	Pick, BARBARA	210,211
CRILE WOOD	92	ROCHESTER Arterienklemme	45	PIERCE Trokar f. Kieferhöhle	90
DE BAKEY	93	Trokar Bruststich	90	PIFFARD Lupus Küretten	306
DERF	92	Ohr Zängchen	208,209	PINARD Stethoskope	5
DIETHRICH	96	Ohr Zängchen mikro,		Pinzetten	34
FINOCHIETTO	94	mikromini	205,206	Pinzette, ADLERKREUTZ	36
HALSEY	92	Ohrpinzette, WILDE TROELTSCH	203	ADSON	35
HEANEY	93	Ohrsonde, STACKE aus Silber	88	ADSON BROWN	35
HOESEL	95	Ohrspekulum, BRUENINGS		ADSON Hypophysen	170
JAMISON	93	pneumatisch	198	ADSON micro	35
JOHNSON	94	Ohrspritze, REINER	201	Pinzette anatomisch	34
KALT	97	Ohrtrichter, BOUCHERON	198	ARRUGA Kapsel	193
KALT ARRUGA	97	GRUBER	198	AYER Chalazion	195
MASSON	93	HARTMANN	198	BARRAQUER Cilien	197
MATHIEU	95	TOYNBEE	198	BARRAQUER Colibri Iris	189
MAYO HEGAR	92	OLDBERG Zange Laminektomie	173	BARRAQUER Fixier	192
METZENBAUM	94	Olive Nase, Ohr	201	BARRAQUER KATZIN Iris	189
NEIVERT	92	OLIVECRONA Draht Säge	169	BARRAQUER Vorderkammer	191
OLSEN HEGAR	95	Hirn Spatel	171	BEER Cilien	197
RYDER	93	Hohlmeißelzange	110	Bipolare Koagulation	316-318
SAROT	94	TOENNIS Clip Zange	166	BISHOP HARMAN Iris	190
STEVENS	96	OLLIER Wundhaken	72	BONACCOLTO Strabismus	190
STRATTE	94	OLSEN HEGAR Nadelhalter	95	Bonn Iris	190,191
TOENNIS	94	Ophthalmoskope	2	BROWN gezahnt	35
WANGENSTEEN	93	Osteotome	121-123	CASTROVIEJO Fixier	192
YOUNG Bumerang	99	Osteotom, HIBBS	123	CASTROVIEJO Kapsel	193
Nadelrad, WARTENBERG	7	LAMBOTTE	122	CASTROVIEJO Naht	194
NAEGELE Geburts Zange	300	STILLE	121	Cilien	197
Nähnadeln	102,103	Otoskop Besteck	3	COLLIN DUVAL	36
Nähnnadel, KOENIG	103	OVERHOLT Doppelraspatorium	128	COOLEY Atrauma	40
Nagel, BOEHLER	149	GEISSENDOERFER		CUSHING	35
Nagel Feile	307	Präparierklemme	49	DASTOOR Strabismus	190
Nagel Haken	146	Parametrien Scheren	24	DEBAKEY Atrauma	40
JEWETT	150	PARHAM Band	118	DESMARRES Chalazion	195
KUENTSCHER	147,148	Band Spanner	118	DOUGLAS Cilien	197
Nagel Schere	307	PARK Sperrelevator	179	DUVAL	36
SMITH PETERSEN	149	PARKER Skalpell	14	ELSCHNIG Fixier	192
Nagel Zange	307	Wundhaken doppelt, Paar	64	ELSCHNIG Kapsel	193
Nagelhaut Zange	307	PARTSCH Flachmeißel	121	FERRIS SMITH	36
NAGER Gaumensegel Haken	235	Hohlmeißel	121	FISCHER Iris	189
Nasenschere, COTTLE	23	PASSOW Meißel Blutstillung	211	FOERSTER Iris	188
FOMON	22	PATON Hornhaut Dissektor	181	FUCHS Kapsel	193
HEYMANN	22	PAUFIQUE Faden Pinzette	194	GERRALD	37
Nasenzange, HEYMANN KNIGHT	215	Keratoplastik Messer	181	GILL ARRUGA Kapsel	192
Navicular, Hohlschraube	152	TITAN Faden Pinzette	194	GILL HESS Iris	188
NEFF Meniskotom	131	PAYR Baby Quetsch Klemme	266	GILLIES	37
NEGUS Tonsillen Klemme	236	Führungshohlsonde	100	GRADLE Cilien	197
NEIVERT COTTLE Haken	227	Quetsch Klemme	266	GRAEFE	35
Nadelhalter	92	SCHMIEDEN		GRAEFE Iris	186,187
NELSON Pinzette	37	Führungshohlsonde	100	GREEN Fixier	192
Trokar Bruststich	90	PEAN Arterienklemmengrazil	45,47	HESS Kapsel	193

	Seite		Seite		Seite
JACKSON Tampon	239	Cystikus Haken	274	Rippenrasatorium, DOYEN	127
JAMESON Strabismus	189	Haken Zange	287	Rippenrasatorium, SEMB	127
JANSEN Nase	214	Rektal Spekulum	272	ROBERTS Arterienklemme	50
KALT Kapsel	193	PRICE THOMAS		ROCHESTER CARMALT	
KIRBY ARTHUR Iris	189	Bronchus Klemme	254	Arterienklemme	46
KNAPP LUER Trachom	195	PRINCE Muskel Pinzette	191	OCHSNER Arterienklemme	45
LAMBERT Chalazion	195	Tonsillenschere	23	PEAN Arterienklemme	45
LANE	36	Proktoskop, KELLY	274	ROEDER Tuchklemme	59
LERCHE	36	PROVIDENCE HOSPITAL		ROGER Septum Elevatorium	221
LESTER Fixier	192	Arterienklemme	44	ROGGE Sterilisierzange	105
LITTAUER Cilien	197	PUTTI Knochen Raspel	132	Rohr, BRUENINGS Verlängerung	240
MARSCHIK Tonsillen	237	Quetscher, SAALFELD		ROLLET Extirpations Meißel	182
McCULLOUGH Strabismus	189	Komedonen	306	Häkchen	182
McINDOE	36	SCHAMBERG Komedonen	306	Rollmesser, SCHUKNECHT	210
McPHERSON Faden	194	UNNA Komedonen	306	ROSE Tracheal Häkchen	246
Micro	39	WALTON Komedonen	306	ROSEN Messer Rundschnitt	210
MOORFIELD Naht	194	QUINBY Zahnfleisch-Schere	29	Nadeln	210,211
NELSON	37	QUIRE Hebel Fremdkörper	204	ROSENBERG Zangen Aufsatz	240
PAUFIQUE Faden	194	QUISLING Hammer intranasal	125	ROSER KOENIG Mundsperrer	231
POTTS SMITH	34	RADOLF Nagelauseißzange	133	ROUX Wundhaken	64
PRINCE Muskel	191	Rahmenhaken	85	ROWE Repositions Zangen	234
Pinzette russisches Modell	36	RALK Bohraparat	135	RUBIN Septum Quetsch Zange	217
Pinzette schmal	34	RAMPLEY Schwamm Zange	61	RUMEL Thoraxklemme	50
SCHWEIGGER Kapsel	193	RANDALL Nierenstein Zange	258	Rundloch, Platte breit	158
SEMKEN	37	Saug Kürette	290	Platte schmal	157
SINGLEY	37	RANEY Anlege- u.		RUSKIN Hohlmeißel Zange	111
SNELLEN Entropium	195	Abnahme Zange	167	Hohlmeißelzange	111
St. MARTIN Naht	194	Kopfhaut Klammer	167	LISTON Knochen Splitterzange	113
STEVENS Iris	187	Rasierklinge f. Mikrochirurgie	13	STILLE Hohlmeißelzange	112
STILLE	34	Rasiermesser	16	russisches Modell, Pinzette	36
TERSON Kapsel	193	Rasatorium, ALEXANDER	126	RYDEL SEIFFER Stimmgabel	200
TROELTSCH Nase	214	FARABEUF	126	RYDER Nadelhalter	93
TROUTMAN Colibri Iris	189	LAMBOTTE	126	SAALFELD	
Tübingen TITAN Iris	191	LANGENBECK	126	Komedonen Quetscher	306
Tübingen Faden	194	MATSON	128	SACHS Dura Dissektor	169
Uhrmacher	38	MATSON ALEXANDER	128	Nerv Haken	168
Pinzette USA	34	SEDILLOT	126	Säge, BERGMANN Gips	106
WACHENFELDT	104	WILLIGER	126	CHARRIERE Amputations	133
WANGENSTEEN	37	Raspel, AUFRICHT Nasen	224	Fingerring	133
PIPER Geburts Zange	302	FOMON Nasen	225,226	ENGEL Gips	106
PITHA Mund Keil	234	GALLAHER Antrum	226	JOSEPH Nasen	227
Platte, Knochen	156-164	JOSEPH (LEWIS) Nasen	225	LANGENBECK Finger	133
Platte breit	158	Knochen	132	OLIVECRONA Draht	169
Platte Finger	162	MALTZ (COTTLE) Nasen	225	SATTERLEE Blatt	133
Platte Hüft, dynamisch	151	PUTTI Knochen	132	WIGMORE Gips	106
Platte, JAEGER Lid	179	WIENER (AUFRICHT) Nasen	225	Sägeblatt	133
Platte Klein Fragment	163	WIENER Antrum	225	Sägeblatt für Gipsschere	
Kondylen	159,160	RECAMIER Küretten	299	elektrisch	107
McLAUGHLIN	149	REICHERT Kehildeckel Halter	239	Sägen Bohrer Fräser Besteck	138
Platte Mini Finger	163	REINER Gips Messer	108	Sägezange, Fingerring	133
Platte Mini Fragment	163	Ohrspritze	201	SAENGER Plazenta u.	
Platte Mini gerade	162	Retraktor, LOVE Zäpfchen	235	Abortus Zange	304
Platte schmal	157	REVERDIN Bauchspatel	66	Salpingograph, SCHULTZE	297
SHERMAN	???	Nadel	99	SANVENERO Schere	21
SMITH PETERSEN	149	REYNOLDS Schere	21	SAROT Bronchus Klemme	255
PLESTER Lappen Messer	210	Rhachiotom	124	Bronchusklemme	51
Wundsperrer	76	RIBBON Bauchspatel	66	Nadelhalter	94
POLITZER Luft Dusche	201	RICHARDSON EASTMAN		SATINSKY	
Paracentese Nadel	202	Wundhaken	66	Anastomosen Klemmen	255
Polypen Greifer	244	RICHTER HEATH		Thorax Schere	27
POOLE Saugrohr	8	Wundklammern Zange	104	SATO Hornhaut Messer	181
POTTS DE MARTEL Gefäß Schere	23	Richtzange, ASCH Septum	228	SATTERLEE Blatt Säge	133
POTTS SMITH Gefäß Schere	24	RIGBY Wundsperrer Rectum,		SAUERBRUCH FREY	
POTTS SMITH Pinzette	34	Vagina	86	Rippen Schere	249
Präparier- Schere	26	Ringmesser, StCLAIR THOMSON	229	Hohlmeißel Zangen	112
Präparierschere, WERTHEIM	25	Rippen Kontraktor	253	Nadel Etui	308
PRATT Arterienklemme	47	Rippen Schere	248	Rippen Schere	249

	Seite		Seite		Seite
Wundhaken	75	Schere micro	207	SCHOENBORN	
Sauger, DASTOOR Kapsel	185	Nabelschnur US Modell	26	Schildrüsen Haken	247
Saugrohr, ADSON	171	Nagel	307	SCHOENBURG Faß Zange	260
POOLE	8	Nerv Präparier-	26	Schraube Spongiosa	155
YANKAUER	8	NORTHBENT (SPENCER) Ligatur	28	Schraube Hüft dynamisch	151
Saugspritze, MENGHINI	91	NOYES Iris	32	Schraube Kompression	151
SAWTELL Tonsillen Klemme	236	Parametrien	24	Schraube Kortikalis	153,154
SCAGLIETTI Hohlmeißel Zangen	112	POTTS DE MARTEL Gefäß	23	Schraube Malleolar	154
SCHAEDEL Tuchklemme	59	POTTS SMITH Gefäß	24	Schraube Mini Kreuzschlitz	153
Schädelspalter, VIRCHOW	124	Präparier-	26	Schraube Spongiosa	153-155
Schädelzange, DeVILBISS	169	REYNOLDS	21	Schraubendreher f. Hohlschraube	145
Schale, Instrumenten	310	Rippen	248	Schraubendreher Innensechskant	144
Lösungen	309	SANVENERO	21	Schraubendreher, LANE	144
Petri	310	SATINSKY Thorax	27	SCHROEDER Haken Zange	286,287
SCHAMBERG Komedonen		SAUERBRUCH FREY Rippen	249	SCHUBERT Biopsie Zange	291
Quetscher	306	SAUERBRUCH Rippen	249	SCHUKNECHT Rollmesser	210
SCHEDE scharfe Löffel	119	SCHMIEDEN TAYLOR Dura	27	Sichelmesser	210
Scheibe zur Schnittbegrenzung	138	SCHUMACHER Nabelschnur	26	SCHULTZE Salpingograph	297
SCHEIE Augen Kanüle	196	SHEA mikro	205	SCHUMACHER Biopsie Zange	293
Goniotomie Messer	181	SIEBOLD gynäkologisch	25	Nabelschnur Schere	26
SCHEINMANN Zangen Aufsatz	240	SIMS Uterus	25	Zangen Aufsatz	240
Schere, AEBLI Hornhaut	22	SMITH US Army Gaze	29	Schutzhülse, Gewebe	145
BARRAQUER Colibri Iris	32	Scheren, chirurgisch	18	SCHWEIGGER Kapsel Pinzette	193
BEEBEE	29	SPENCER Ligatur	28	Schwestern Garnitur	307
BELLUCCI mikro	205	STILLE Gips	106	Schwingmesser, BALLENGER	221
BERGMANN Verband	30	STILLE Rippen	248	SEDILLOT Raspatorium	126
BETHUNE Rippen	249	Strabismus	22	SEEMANN SEIFFERT	
BEUSE gezahnt	23	STRULLY neurochirurgisch	26	Mundsperrerr	232
BRAUN STADLER Episiotomie	26	THOREK Lungen (Thorax)	27	SEGOND Myom Messer	296
BRUNNER Rippen	249	TOENNIS ADSON		Sehnenstripper, BUNNELL	132
BRUNS Verband	30	neurochirurgisch	26	SEIFFERT SEEMANN	
BUSCH Nabelschnur	26	Universal Verband	30	Mundsperrerr	232
CASTROVIEJO Hornhaut	33	VANNAS Iridectomie	33	Zangen Aufsatz	240
CASTROVIEJO Iridektomie	32	WAGNER	29	SELLHEIM Geburts Löffel	305
CORYLLOS Rippen	249	WECKER Iris	32	SEMB Bronchus Klemme	255
CRAFOORD Lungen(Thorax)	27	WESTCOTT Iridektomie	39	Hohlmeißelzange	113
DANDY neurochirurgische	27	WESTCOTT Sehnen	32	Knochen Haltezange	114
Darm	28	WULLSTEIN mikro, mikromini	207	Knochensplitter Zange	114
DEAVER	19	SCHIMMELBUSCH		Rippenraspatorium	127
DEBAKEY Gefäß	24	Trommelverbandstoff	311	SEMKEN Pinzette	37
Excenter Verband	30	SCHINK Dermatome komplett	15	SEMM Spekulum	277
DOYEN gynäkologisch	25	SCHIOETZ Tonometer	197	SENN GREEN Wundhaken	66,69
DUBOIS gynäkologisch	25	Schlauch Klemmen	58	Septatom, BRUENINGS	221
Enukleations	22	Schlinge, ARLT Draht	184	Sequester Zange	117
ESMARCH Verband	30	BILLEAU Ohr	203	SEXTON Ohr Messer	202
Gefäß	23	Elektrode für HF-Chirurgie	314,315	SHEA Schere gerade mikro	205
GIERTZ STILLE Rippen	249	SNELLEN Draht	184	Scheren mikro	205
GILLIES Nadelhalter	95	WEBER Draht	184	SHERMAN Platte Knochen	164
Gips	30	WILDER Draht	184	Schraube Knochen	164
GLUCK Rippen	248	Schlingen, Tonsille	237	STILLE Bohraparat	134
Haut	307	Schlitzhammer	143	Sichelmesser, SCHUKNECHT	210
HEATH Ligatur	28	Schloß, STONE WATT allein	263	TABB	210
Iris	21	Schlüssel, Paar für		WULLSTEIN	210
JOSEPH	21	elektr. Gipssch	107	SIEBOLD gynäkologische Schere	25
KELLY Fistel	25	SCHMIEDEN Führungshohlsonde	100	Siebschale Drahtgeflecht	312
KILNER	21	PAYR Führungshohlsonde	100	Siebschale Lochblech	312
LEXER, LEXER Baby	20	TAYLOR Dura Schere	27	SIEGLE Ohrspekulum	
LISTER Verband	30	SCHNIDT Tonsillen Klemme	236	pneumatisch	198
LORENZ Verband	30	Schnürer, BRUENINGS		Silber Klammern Gehirnnaht	266
MAYO (HARRINGTON)	19	Tonsillen	237	SILVER Nasenplastikmeißel	224
MAYO	19	EVES Tonsillen	237	SIMCOE Naht Kanüle	196
MAYO NOBLE	19	KRAUSE Nasen	219	SIMON Bauchdeckenhaken	74
MAYO STILLE	19	KRAUSE Ohrpolypen	203	scharfer Löffel	120
McGUIRE Hornhaut	32	TYDING Tonsillen	238	Uterus Löffel scharf	297
METZENBAUM,		WESTON Rektal Polypen	275	SIMPSON BRAUN Geburts Zange	300
METZENBAUM fino	20,21	WILDE Nasen	219	Geburts Zange	300
Micro, Micro gyn	33	WILDE Ohrpolypen	203	LUIKART Geburts Zange	301

	Seite		Seite		Seite
SIMS Küretten	299	ELSCHNIG Cyclodialysen	184	STACKE Ohrsonde	88
Rektal Spekula	272	FOREGGER Laryngoskope	9	Standgefäß	310
Spekula Vaginal	281	FRENZEL Zungen	230	Stanzbesteck, KEYES Haut	306
Uterus Depressor	289	HABERER biegsam	66	Stanze, BAGGISH Biopsie	295
Uterus Dilator	285	HEIFETZ Hirn biegsam	171	BEYER	218
Uterus Schere	25	KOCHER Blasen	268	BURKE Biopsie oval	294
Uterus Sonden	289	LEGUEU Blasen	268	CITELLI	218
SINGLEY Pinzette	37	McINTOSH Laryngoskope	9	COLCLOUGH	175
Skalpell mit Metallheft	14	McIVOR	233	DIETER Hammerkopf	206
Skalpell, Einmal steril	12	Mund Holz	230	Faden	244
JOSEPH Nase geknöpft	220	WECKER Iris	184	FERRIS SMITH KERRISON	174
Skalpell Klinge steril	11	WHEELER Cyclodialysen	185	HAJEK CLAUS Kieferhöhle	218
PARKER fein	14	Spekulum, ALAN PARKS Rektal	273	HAJEK KOFLER	218
Skalpellgriff, COLLIN	10	AUVARD Vaginal	282	HOLTH Kapsel	185
Skalpellgriffe	10	BARR Rektal	272	KERRISON	218
Skarifikateur, GRAEFE	180	BODENHAMMER Rektal	272	KEVORKIAN Pacific Biopsie	294
SKENE Haken Zange	286	BREISKY Vaginal	282	TISCHLER KEVORKIAN	294,295
SLUDER BALLENGER		COLLIN Vaginal	276	TOWNSEND mini	294,295
Tonsillotom	238	COTTLE Nase	213	Starmesser DEUTSCHMANN	179
SMELLIE Geburts Haken	303	CUSCO Vaginal	276,277	GRAEFE	179
Perforatorium	305	CUSCO Vaginal		Star Nadeln	181
SMILLIE Meniskotom	131	Schweizer Modell	277	STAUE MOORE Haken Zange	286
SMITH BUIE Rektum Spreizer	273	CZERNY Rektal	272	StCLAIR THOMSON Ringmesser	229
FERRIS Pinzette	36	DOYEN Vaginal	281	STEINMANN Knochennagel	139
FERRIS Zange Laminektomie	173	GRAVE Vaginal	276	Sterilisierklammer, BUNT	105
HEYWOOD Hämorrhoidal		HARTMANN HALLE Nase	212	MAYO	105
Zange	275	JACKSON Vaginal	281	Sterilisierzangen	105
PETERSEN Flachmeißel,		KALLMORGEN Vaginal	280	Sterilisierzange, CHEATLE	105
Hohlmeißel	122	KILLIAN Septum	213	ROGGE	105
PETERSEN Nagel	149	KOGAN Endo-	282	STERNBERG Lippen Halter	230
PETERSEN Platte	149	KRISTELLER Vaginal	278-280	Sternummeißel, LEBSCHKE	124
POTTS Gefäß Schere	24	LANDAU Vaginal	282	Stethoskop, BOWLES	5
POTTS Pinzette	34	MATHIEU Rektal	272	Duplex	5
Sperrelevator	178	PEDERSON Vaginal	276	FORD	5
US Army Gaze Schere	29	PRATT Rektal	272	FORD BOWLES	5
SMITHWICK Clip-Anlegezange	166	SEMM Vaginal	277	PINARD	5
Nerv Haken	168	SIMS Vaginal	281	STEVENS Iris Pinzette	187
SNELLEN Draht Schlinge	184	SIMS Rektal	272	Linsen Haken	182
Entropium Pinzette	195	THUDICHUM Nase	212	Nadelhalter	96
SOMER Uterus Faß Zange	288	TIECK HALLE Nase	213	Tenotomie-Scheren	22
Sonde, BAKES Gallenstein	257	TRELAT Vaginal	277	STEVENSON Sperrelevator	179
BOWMAN Tränenkanal	186	VOLTOLINI Nase	212	STIEGLITZ Splitterzange	38
COLLIN Uterus	289	Wiener Modell	212	STILLE Bohraparat	134
DESJARDINS Gallenstein	257	SPENCER Ligatur Schere	28	Flachmeißel	121
Knopf-	88	WELLS Arterienklemme	46	GIERTZ Rippen Schere	249
KOCHER Kropf	247	Sperrelevatoren	178,179	Gips Schere	106
MARTIN Uterus	289	Spiegel Ersatz für Ziegler Stirnspi	4	HAGLUND Gips Spreizer	108
MAYO Nieren Stein	258	Spiegel-Griff für Kehlkopfspiegel	241	Hohlmeißel	121
MOYNIHAN Gallenstein	257	Kehlkopf	241	HORSLEY Knochen	
Myrtenblatt	88	MICHEL, Postrhinoskopie	214	Splitter Zange	114
OCHSNER Gallenstein	256	ZIEGLER allein	4	LISTON Knochen Splitter Zange	113
SIMS Uterus	289	Spiralbohrer	134,137	LUER Hohlmeißel Zange	111
Spanner, GUYON Katheter	270	Splitterpinzetten	38	MAYO Scheren	19
PARHAM Band	118	Splitterpinzette, CARMALT	38	Nierenstielklemme	55
Spannfutter, Jacobs Dreibacken	136	FEILCHENFELD	38	Osteotom	121
Spannplatte allein für Dermatome	15	HUNTER	38	Pinzette	34
Spannschlüssel f.		Splitterpinzette mit Lupe	38	Rippen Schere	248
Extensionsbügel	140	Splitterzängchen, PEET	38	RUSKIN Hohlmeißelzange	112
Spatel, ALLISON Lungen	253	Splitterzange, ARCHER	38	SHERMAN Bohraparat	134
BANGERTER Cyclodialysen	184	STIEGLITZ	38	Stimmgabel, DIMEDA Alu	199
BRUENINGS Zungen	230	VIRTUS (RALK)	38	HARTMANN	199
BUCHWALD Zungen	230	Spongiosa-Schrauben	153-155	LUCAE	200
CASTROVIEJO		SPRATT scharfe Löffel	119	Stimmgabel neurol. mit Hammer	200
Cyclodialysen	184,185	Spritze, Tonsillen	238	RYDEL SEIFFER	200
CULLER Iris	184	Spülschale	309	Stirnband allein	4
CUSHING Hirn	171	SPURLING Zange Laminektomie	172	Stirnlampe, CLAR	4
DAVIS BOYLE	232	St. MARTIN Naht Pinzette	194	Stirnspiegel, ZIEGLER	4



	Seite		Seite		Seite
STOCKMANN Penis Klemme	270	TISCHLER MORGAN Stanze	294	US Army Wundhaken	65
STONE Verschuß Klemme	263	TOYNBEE Ohrtrichter	198	SMITH Army Gaze Schere	29
WATT Darm Klemme	263	Tracheotomie Besteck in Etui	246	Valven, CASPAR	80,82
WATT Schloß allein	263	TRAUBE Hammer	6	CLOWARD	79
Stopfer, LUNIATSCHEK Tampon	235	TRELAT Spekulum	277	van BUREN Sequester Zange	117
Strabismus Scheren	22	Trephne, CASTROVIEJO	196	van DOREN Biopsie Zange	292
STRATTE Nadelhalter	94	FRANCESCHETTI	196	VANNAS Iridectomie Schere	33
STRAUSS Penis Klemme	270	KEYES Haut	306	Varifocal Ophthalmoskop	2
Rektoskop	273	Trephinen, ELLIOT	197	vBUREN Harnröhrenbougies	271
Stripper, Gefäß	89	TROELTSCH Nasen Pinzette	214	Venenstauer „Clip“	2
STRUEMPEL Ohrzängchen	204	WILDE Ohrpinzetten	203	VERBRUGGE	
STRULLY		TROEMNER Hammer	6	Knochenhalte Zange	116
neurochirurgische Schere	26	Trokar Bauchstich	90	VERRES Pneumoperitoneum Nadel	91
STRUYCKEN Nasen Zange	217	Trokar, COAKLEY für Kieferhöhle	90	VIRCHOW Knorpelmesser	16
Stütze, Bohrdraht	135	FLEURANT für Blasenstich	90	Schädelspalter	124
SWEET Clip-Anlegezange	166	Trokar für Bauchstich	90	VIRTUS (RALK) Splitterzange	38
TABB Sichelmesser	210	LICHTWITZ Kieferhöhle	90	VOLKMANN Doppellöffel scharf	120
TARNIER Geburts Zange	302	NELSON Bruststich	90	scharfe Löffel	119
Kranioklast	305	OCHSNER Bruststich	90	Wundhaken	69,70
Taschenbesteck, aseptisch	105	PIERCE für Kieferhöhle	90	VOLTOLINI Nasen Spekula	212
TAYLOR Hammer	6	UCKERMANN	245	Vorböhrer, CRUTCHFIELD	167
SCHMIEDEN Dura Schere	27	Trokar Universal Bauchstich	90	für Hohlschrauben	145
Spinal Haken	131	Trommel, KONRICH, Filter,		KUENTSCHER	143
TEALE Haken Zange	287	Sterilisier	311	Vorschläger, LLOYD	
TERSON Kapsel Pinzette	193	SCHIMMELBUSCH,		und Nagelzieher	144
THOMAS PRICE		Verbandstoff	311	Vorschlaginstrument,	
Bronchus Klemmen	254	TROUSSEAU Tracheal Dilatator	245	KUENTSCHER	143
THOMS ALLIS Zange	259	TROUTMAN CHRIS		vPETZ Magen-u. Darmnähsapparat	266
GAYLOR Biopsie Zange	292	Klingenbrecher	13	WACHENFELDT	
THOMSON StCLAIR Ringmesser	229	Colibri Iris Pinzette	189	Pinzette für Wundklamme	104
WALKER Blasen- und		Rectus Pinzette	191	Wundklammern	104
Wundsperrer	268	Tuchklemme, BACKHAUS	59	WADSWORTH TODD Kauter	184
Thoraxklemme, RUMEL	50	BERNHARD	59	WAGENER Häkchen Knopf	203
Thoraxschere,		DOYEN mit Ring	59	MOSHER Lebensretter	246
KLINKENBERGH LOTH	27	JONES	59	WAGNER Schere	29
THOREK Lungen (Thorax) Schere	27	Tuchklemme Kugel und Schale	59	Zange Laminektomie	173
THUDICHUM Nasen Spekulum	212	LANE	59	WALLICH Abortus Löffel	304
TIECK HALLE Nasen Spekulum	213	LORNA	59	WALSHAM Septum Richtzangen	228
TILLEY Ohr Zängchen	204	MOYNIHAN	59	WALTON Fremdkörper Meißel	182
TISCHLER KEVORKIAN Aufsatz	294	ROEDER	59	Komedonen Quetscher	306
KEVORKIAN Stanze	295	SCHAEDEL	59	Wangen Halter Simplex	231
MORGAN Aufsatz	294,296	Tübingen Faden Pinzette	194	WANGENSTEEN Nadelhalter	93
MORGAN Biopsie Zange	293	Tübingen Iris Pinzetten	191	Pinzette	37
TIVNEN Tonsillen Faß Zange	237	Tübingen Luft Kanüle	196	WARTENBERG Nadelrad	7
TOBOLD Kehlkopf Watteträger	89	TUFFIER Arterienklemme	47	WATSON CHEYNE	
Zungen Drücker	230	Rippen Sperr	252	Doppelelevatorium	129
TOENNIS ADSON		Tupferzange, CHERON	62	Watteträger	89
neurochirurgische Schere	26	COLLIN	62	FARREL dreikantig	89
Arterienklemme	50	PELKMANN	62	JOBSON HORNE	89
Dura Dissektor	169	TURNBULL Nagel Zange	307	TOBOLD Kehlkopf	89
Nadelhalter	94	TURREL Rektum Biopsie Zange	275	UCKERMANN	89
OLIVECRONA Clip Zange	166	TYDING Tonsillen Schnürer	238	WEBER Draht Schlingen	184
Tonometer, SCHIOETZ	197	Tonsillen Faß Zange	237	WECKER Iris Schere	32
Tonsillen Schlingen	237	UCKERMANN Trokar	245	Iris Spatel	184
Tonsillen Kanüle	238	Watteträger	89	WEEK Sperrelevator	178
Tonsillen Spritze	238	Uhrmacher Pinzetten	38	WEIL BLAKESLEY Zange	216
Tonsillenschere, BOETTCHER	23	ULRICH Tupfer Zange	60	WEITLANER WULLSTEIN	
DEAN	23	Umführungs-Instrument		Wundsperrer	76
GOOD	23	De MARTEL	169	WELLS E nukleation Löffel groß	184
PRINCE	23	Universal Diagnostik Besteck	3	SPENCER Arterienklemme	46
Tonsillotom,		Universal Drahtscheren	29	WERTHEIM CULLEN	
SLUDER BALLENGER	238	Universal Faßzangen	105	Hysterektomie Klemm	57
TOOK Hornhaut Messer	181	Universal Verband Schere	30	Präparierschere	25
TOTI Fräser	137	UNNA Komedonen Quetscher	306	WEST Nasen Meißel	224
TOWNSEND KEVORKIAN		Unterlegscheiben		WESTCOTT Iridectomie Schere	39
Stanzen	294,295	f. Knochenschraube	152,153,153	Sehnen Schere	32
mini Aufsatz	294	Urethrotom, MAISONNEUVE	269	WESTON Rektal Polyphen Schnürer	275

	Seite		Seite		Seite
WHEELER Cyclodialyse Spatel	185	ROUX Mini doppelt	64	Ohr	204-209
Diszissions Messer	180	SAUERBRUCH	75	Ohr mikromini	208,209
WHITE Tonsillen Faß Zange	236	SENN doppelt	66	TILLEY Ohr	204
WHITEHEAD Mundsperrer	232	SENN GREEN	69	WILLIAMS Faß	260
WIEDER Zungen Drücker	230	US Army doppelt Paar	65	Zahnfleisch-Schere	29
WIENER (AUFRICHT)		VOLKMANN	69,70	Zange, ALEXANDER Biopsie	292
Nasen Raspel	225	Wundklammer Besteck Metalletui	105	ALLIS ADAIR	259
Antrum Raspel	225	Wundklammern, MICHEL	104	ALLIS Baby Faß-	259
Iris Häkchen	182	RICHTER HEATH Zange	104	ALLIS Darm- und Gewebe-Faß-	259
Wiener Modell Spekula	212	WACHENFELDT	104	Anlege Clips	177
WIGMORE Gips Säge	106	Wundklammerpinzette,		BALLENGER Tonsillen Faß-	237
WILDE Nasen Schnürer	219	HEGENBARTH	104	BARRETT Haken	286
Schnürer Ohrpolypen	203	MICHEL	104	BARTON Geburts	301
TROELTSCH Ohrpinzetten	203	WACHENFELDT	104	Biopsie isoliert für Koagulation	243
WILDER Draht Schlinge	184	Wundnahtbesteck in Metalletui	105	Biopsie flexibel, f. Gastroskopie	242
Tränenkanal Dilatator	186	Wundsperrer, ADSON	77	BIRCHER GANSKE	
WILLET MARTEL Kopfhautklemme	47	ADSON Baby	77	Knochenhalte	117
WILLIAMS Faß Zängchen	260	ALM	76	BLAKE Gallenstein	256
Schraubendreher u. Halter	144	BECKMANN	78	BLOHMKE Tonsillen Faß-	237
Sperrelevator	178	BECKMANN EATON	78	BLUMENTHAL Hohlmeißel	109
WILLIGER Doppellöffel scharf	120	BOSE Tracheal	245	BOEHLER Hohlmeißel	111
Hammer	125	CASPAR Laminektomie	81	BOEHLER Knochen splitter-	113
Raspatorium	126	CLOWARD	79	BOERMA Geburts	302
Winkelmesser, MOELTGEN	7	DARLING	79	BOZEMANN DOUGLAS	
Winkelplatte	159,160	FINOCHIETTO Alu	250	Schwamm	63
WINTER Plazenta		FINOCHIETTO BURFORD	251	BOZEMANN Schwamm	63
u. Abortus Zange	304	FINOCHIETTO	250	BRAUN Haken-	286
Wirbelkörper, INGE Spreizer	171	FINSEN	76	BRUENINGS Nase, scharf	215
WITTNER Biopsie Zange	293	FRIEDMAN Perineorrhaphie	282	CHEVALIER JACKSON	241
WOLFF Gipsabreiß Zange	108	GELPI Perineal	86	COLLIN Uterus Faß-	288
WOOD CRILE Nadelhalter	92	HAIGHT Rippen	252	COLLIN Zungen	231
WRIGLEY Geburts Zange	300	JANSEN	76	COLVER Tonsillen Faß-	236
WULLSTEIN HARTMANN		JUDD MASSON Blasen	268	CUSHING Laminektomie	172
Ohrzängchen	204	KILNER DOUGHTY	233	DARTIGUES Uterus Faß-	288
Scheren mikro	207	MERCEDES Thorax	253	de LEE Geburts	300
Sichelmesser	210	MILLIN Blasenhal	269	DeMARTEL WOLFSON	
WEITLANER Wundsperrer	76	MOLLISON	79	Schließ-	264
Wundhaken	72	PLESTER	76	DESJARDINS Gallenstein	256
Wundhaken (Tracheal)	68	RIGBY Rectum, Vagina	86	DEWEY Geburts	302
Wundhaken, CRILE doppelendig	65	THOMSON WALKER Blasen	268	DINGMANN Knochenhalte	117
CUSHING	69	WEITLANER	76	DOYEN Uterus Polypen	288
DEAVER	67	WEITLANER WULLSTEIN	76	DUPLAY Haken-	286
DEAVER Grip	67	Wundspreizer, FRAZIER	83	ELLIOT Geburts	300
FARABEUF doppelt	64	LEGUEU Blasen	269	EPPENDORFER Biopsie	295
FRITSCH	73	Wurzelhaken, LOVE Nerv	168	FAURE Biopsie Uterus	291
GOELET doppelt	65	WYLIE Uterus Dilator	285	FERRIS SMITH Laminektomie	173
GREEN	72	YANKAUER Nasenrachen		Zange flexibel	242
HARRINGTON	67	Spekulum	214	FOERSTER Schwamm	61
HEANEY	74	Saugrohr	8	FRAENKEL Kehlkopf Polypen	239
ISRAEL	73	YASARGIL Clips	176,177	Fremdkörper	244
KELLY	66,74	YEOMAN Rektum Biopsie Zangen	275	FRIEDMAN Hohlmeißel	109
KELLY Grip	66	YOUNG Bumerang Nadelhalter	99	GAUSS Kopfschwarten	303
KOCHER	72,73	Ersatznadel	99	GELLHORN Biopsie	292
KOERTE	73	Prostata Faßzange	267	GREEN ARMYTAGE Klemm-	303
LAHEY	70	Prostata Haken	267	HARTMANN Nasen scharf	217
LANGENBECK	71	Zungen Zange	231	HARTMANN Nasenpolypen	214
LITTLE	70	Zängchen, BABCOCK Darmfaß-	259	HEYMANN Nasen scharf	215
MATHIEU doppelt Paar	65	COS Drahtbiege	206	HEYWOOD SMITH	
MEYERDING	70	DUVAL Faß-	260	Hämorrhoidal	275
MIDDELDORPF	72	GREVEN Drahtbiege	206	IOWA Haken	287
MIKULICZ	74	HARTMANN Ohr	204	JACOBS Haken-	287
OLLIER	72	JUERS Drahtbiege	206	JARCHO Haken-	286
PARKER doppelt Paar	64	LITTAUER Ohr	204	JATHO Nasenrachen scharf	228
RICHARDSON	66	McGEE Drahtbiege-	206	JUDD ALLIS	259
RICHARDSON EASTMAN	66	MICHEL z. Anlegen/Abnehmen		JURASZ Kehlkopf Polypen	239
ROUX Baby doppelt	64	v. Wundklammern	104	KELLY Uterus Polypen	288
ROUX doppelt	64			KERN Knochenhalte	115

	Seite		Seite
KEVORKIAN Biopsie	293	STRUYCKEN Nasen	217
KIELLAND Geburts	300	TARNIER Geburts	302
KIELLAND LUIKART Geburts	301	TEALE Haken-	287
KNIGHT Nasen scharf	215	THOMS ALLIS	259
Knochenhalte	117	THOMS GAYLOR Biopsie	292
Knochenhalte selbstzentrierend	116	TISCHLER MORGAN Biopsie	293
LAMBOTTE Knochenhalte	115	TIVNEN Tonsillen Faß-	237
LANE Knochenhalte	115	TURNBULL Nagel	307
LEKSELL(STILLE)Hohlmeißel	112	TURREL Rektum Biopsie	275
LEMPERT Hohlmeißel	110	TYDING Tonsillen Faß-	237
LEWIN Knochenhalte	117	ULRICH Tupfer	60
LISTER (Sinus) Tupfer	62	VAN BUREN Sequester	117
LISTON Knochensplitter	113	van DOREN Biopsie	292
LITTAUER Nasen Polypen	215	VERBRUGGE Knochenhalte	116
LOVE GRUENWALD		WEIL BLAKESLEY Nasen-	216
Laminektomie	172	WHITE Tonsillen Faß-	236
LUBET BARBON		WINTER Plazenta- und Abortus	304
Nasen Polypen	215	WITTFNER Biopsie	293
LUC Nasen scharf	216	WOLFF Gipsabreiß	108
LUIKART Geburts	301	WRIGLEY Geburts	300
MATHIEU Fremdkörper	269	YEOMAN Rektum Biopsie	275
MAYO BLAKE Gallenstein	256	YOUNG Zungen	231
McLEAN Geburts	301	ZAUFAL JANSEN Hohlmeißel	111
McLEAN LUIKART Geburts	301	ZAUFAL JANSEN	
McLEAN TUCKER Geburts	301	Hohlmeißel Zange	111
McLEAN TUCKER LUIKART		ZENKER Präparier-/Ligaturklemme	51
Geburts	301	ZIEGLER Iris Messer	180
MIDDLETON JANSEN scharf	219	Kapsulotomie Messer	181
MILLIN Faden Führungs	267	Sperrelevator	179
MIXTER Gallenstein	256	Spiegel	4
MUSEUX Haken-	287	Tränenkanal Dilatator	186
MYLES Nasen	217	Zirkel, COLLIN Becken	303
NAEGELE Geburts	300	COLLYER Becken	303
Nagel	307	MARTIN Becken	303
Nagelhaut	307	Zughaken für Extensionsbügel	140
NOTO Uterus Polypen	288	Zughebel, BARTON	301
NOYES Nasen Polypen	215	LUIKART BILL	302
OLDBERG Laminektomie	173	Zugendrücker,	
OLIVECRONA TOENNIS Clip	166	KILNER DOUGHTY	233
PIPER Geburts	302		
PRATT Haken-	287		
RAMPLEY Schwamm	61		
RANDALL Nierenstein	258		
RANEY Anlege- u. Abnahme	167		
ROWE Reposition	234		
RUBIN Septum Quetsch	217		
RUSKIN Hohlmeißel	111		
RUSKIN LISTON			
Knochen Splitter	113		
SAENGER Plazenta-			
und Abortus	304		
SAUERBRUCH Hohlmeißel	112		
SCHOENBURG Faß-	260		
SCHROEDER Haken-	286,287		
SCHUBERT Biopsie	291		
SCHUMACHER Biopsie	293		
SEMB Knochensplitter	114		
Sequester	117		
SIMPSON BRAUN Geburts	300		
SIMPSON Geburts	300		
SIMPSON LUIKART Geburts	301		
SKENE Haken	286		
SOMER Uterus Faß-	288		
STAUDE MOORE Haken-	286		
STILLE LISTON			
Knochen Splitter	113		
STILLE LUER Hohlmeißel	111		

# Table of Contents

Group		Page
102	Diagnostics	1- 7
104	Anesthesia	8- 9
106	Scalpels, Knives	10- 16
108, 109	Scissors	18- 33
110, 111	Thumb and Tissue Forceps	34- 40
112	Hemostatic Forceps	42- 57
112	Tubing Clamps	58
114	Towel Clamps	59
116	Polypus and Dressing Forceps	60- 63
118	Retractors	64- 87
120	Probes, Cotton Applicators	88- 89
122	Trocars, Puncture Needles	90- 91
124, 126	Suture	92- 104
128	Sterilizing Aids	105
130	Plaster-of-Paris	106- 108
132 -136	Bone Surgery, Osteosynthesis	109- 166
140	Neurosurgery, Laminectomy	167- 177
142	Ophthalmology	178- 197
144	Otology	198- 211
146	Rhinology	212- 229
148	Mouth and Tongue	230- 234
150	Tonsils	235- 238
152	Larynx	239- 241
153	Flexible Forceps, Endoscopic	242- 244
154	Tracheostomy	245- 246
154	Goitre	247
156	Thorax	248- 255
162	Gall Bladder	256- 257
164	Kidney	258
164	Intestines, Stomach	259- 266
166	Urology	267- 271
168	Rectum	272- 275
170	Gynecology	276- 299
172	Obstetrics	300- 305
174	Dermatology, Hygiene	306- 307
188	Instrument Boxes and Trays	308- 312
190	HF Surgery (Diathermy)	314- 319

	Page		Page		Page
abdominal trocars	90	AUVARD speculum vaginal	282	BEST intestinal forceps	263
adenotome, LAFORCE	229	AXENFELD chalazion curette	183	BETHUNE rib shears	249
ADLERKREUTZ forceps	36	AYER chalazion forceps	195	BEUSE scissors toothed	23
ADSON aspirating tube	171	<b>BABCOCK</b> forceps	259	BEYER punch	218
baby hemostatic forceps	48	BABINSKY hammer	6	rongeur	111
baby retractor	77	BACKHAUS towel forceps	59	BILL LUIKART tractor	302
BROWN forceps	35	BAGGISH biopsy punch	295	BILLEAU ear loops	203
dura retractor	168	BAILEY baby approximator	253	biopsy coagulation forceps	243
elevator	128	GIBBON approximator	253	biopsy forceps flexible,	
forceps	35	rib approximator	253	gastroscopic	242
hemostatic forceps	48	BAINBRIDGE hemostatic forceps	53	bipolar cord for bipolar forceps	319
micro forceps	35	BAKES gall stone probes	257	bipolar forceps	316-318
needleholder	94	BALFOUR abdominal retractor	84	BIRCHER GANSKE	
pituitary forceps	170	baby abdominal retractor	84	bone holding forceps	117
retractor	77	ball electrode, coagulation	315	meniscotome	131
rongeur	110	and socket towel clamp	59	BISHOP HARMAN iris forceps	190
TOENNIS neurosurgical		<b>BALLENGER HAJEK</b>		blade, ALAN PARKS with	
scissors	26	septum elevator	222	coldlight adaptor	273
AEBLI corneal scissors	22	septum elevator	222	CASPAR	80,80
air bag POLITZER	201	SLUDER tonsillectome	238	circular saw	138
ALAN PARKS rectal speculum	273	sviwel knife	221	CLOWARD	79
ALBEE burrs	137	tonsil seizing forceps	237	COLLIN for abdominal retractor	86
ALEXANDER biopsy forceps	292	band, head	4	FOREGGER laryngoscope	9
chisel	121	PARHAM	118	McINTOSH laryngoscope	9
gouge	121	BANGERTER cyclodial. spatula	184	razor	16
MATSON periosteal	128	bar, GERSTER traction	118	razor blade microsurgical	13
periosteal	126	BARANY noise apparatus	200	saw for electric cast cutter	107
ALLIS ADAIR forceps	259	BARBARA hooklet	210	scalpel sterile	11
JUDD forceps	259	needles	210	blades, Credo corn cutter	307
THOMS forceps	259	picks	210	BLAKE curette	297
ALLISON lung spatula	253	BARKAN goniotomy knife	181	gall stone forceps	256
ALM retractors	76	BARNHILL adenoid currettes	229	MAYO gall stone forceps	256
ALVIS foreign body curette	182	BARR rectal speculum	272	BLOHMKE tonsil seizing forceps	237
amniotome, BEACHAM	289	BARRAQUER anterior chamber		blood pressure apparatus	1
amputation knife	15	forceps	191	BLOUNT bone lever	131
ANDREW tongue depressor	230	cilia forceps	197	knee retractor	131
angiotribe, FERGUSSON	46	Colibri eye speculum	178	BLUMENTHAL rongeurs	109
angled plates	159,160	Colibri iris scissors	32	BODENHAMMER rectal speculum	272
anoscope, HIRSCHMANN	274	fixation forceps	192	BOEHLER bone cutting forceps	113
IVES FANSLER	274	KATZIN iris forceps	189	extension bow	140
apparatus, BARANY noise	200	keratoplasty knife	181	nail	149
compression	132	needleholders	97	rongeur	111
vPETZ suturing	266	BARRAQUER Colibri iris forceps	189	BOERMA obstetric forceps	302
applicators, cotton	89	BARRETT tenaculum forceps	286	BOETTCHEr tonsil scissors	23
cotton	89	BARTON obstetric forceps	301	BONACCOLTO strabismus	
FARREL cotton	89	traction handle	301	forceps	190
JOBSON HORNE cotton	89	battery handles for laryngoscopes	9	bone chisels	121
TUBOLD laryngeal	89	BAUMGARTNER needleholder	92	bone drill flat	137
UCKERMANN cotton	89	BEACHAM amniotome	289	bone hand drill w. Jacobs chuck	136
applying forceps clips YASARGIL	177	BECKER cystotome	182	bone holding forceps	115-118
approximator, BAILEY baby, rib	253	BECKMANN adenoid curette	229	bone levers	129-131
BAILEY GIBBON, rib	253	EATON retractor	78	bone rasps	132
BAILEY rib	253	retractor	78	bone rasp/bone file	132
rib	253	BEEBEE scissors	29	bone surgery engine	136
ARCHER splinter forceps	38	BEER cilia forceps	197	bone wire	141
Arkansas sharpening stone	16	BEESON plaster spreader	108	Bonn iris forceps	190,191
ARRUGA capsular forceps	193	BELLUCCI scissors micro,		Bonn irrigating cannula	196
extraction hooks	182	micro mini	205	Bonn TITAN iris forceps	191
eye speculum	178	BENGOLEA hemostatic forceps	48	BORCHARDT burr	137
GILL capsular forceps	192	BENNETT bone lever	129	BOSE trachea hooks	245
KALT needleholder	97	BERENS keratome	180	tracheal spreader	245
needleholder	96	BERGMANN bandage scissors	30	BOUCHERON ear specula	198
protector	184	plaster cast saw	106	bougie, GUYON dilating	271
ASCH septum		BERKE muscle forceps	191	vBUREN dilating	271
straightening forceps	228	BERLINER hammer	6	bow, BOEHLER extension	140
AUFRICHT nasal rasp	224	BERNHARD towel forceps	59	bows, extension	140
nasal retractor	227	BERTILLON cephalometer	7	KIRSCHNER	140



	Page		Page		Page
KIRSCHNER American	140	burrs, ALBEE	137	CHILDE grasping forceps	104
bowl, kidney	309	CUSHING flat	134	chisel, ALEXANDER	121
round	309	DOYEN	137	bone	121
solution	309	spherical	134	BRUNETTI spine	124
BOWLES FORD stethoscope	5	burrs, set of saws and	138	CINELLI plastics	223
stethoscope	5	BUSCH umbilical cord scissors	26	COTTLE nasal plastics	223
BOWMAN discission knife	180	CAAFoord bronchus clamp	51	FOMON	223
discission needles	181	cancellous screws	153-155	FREER septum	222
eye speculum	178	cannula, Bonn irrigating	196	HIBBS bone	123
lachrymal probes	186	BUIE aspirating	275	HOKE	123
box, glass	308,309	DOUGLAS trocar and	90	LEBSCHKE sternum	124
interior for needle case	308	FRAZIER aspiration	171	LEXER bone	123
KONRICH filter	311	FRAZIER puncture	171	LEXER mini	123
SCHIMMELBUSCH	311	Hamburg buttoned	196	PARTSCH bone	121
BOYNTON needleholder	96	KILLIAN wash	219	ROLLET extirpation	182
BOZEMANN DOUGLAS		SCHEIE eye	196	SILVER plastics	224
swab forceps	63	SIMCOE suturing	196	SMITH PETERSEN	122
needleholder 'S' TC	93	Tübingen air	196	STILLE bone	121
swab forceps	63	cannulated drill	145	chordotome, FRAZIER	170
brace, HUDSON	134	Screw	152	chuck, JACOBS, with handle	136
brain knife	16	tap for screws	145	cilia forceps	197
BRAUN cranioclast	305	CARMALT ROCHESTER		CINELLI chisel	223
decapitation hook	305	hemostatic forceps	46	circular saw blades	138
SIMPSON obstetrical forceps	300	splinter forceps	38	CITELLI punch	218
STADLER episiotomy scissors	26	CARPENTER tonsil knife		clamp, CRAFOORD bronchus	51
tenaculum forceps	286	and enucleator	235	COLLIN umbilical cord	303
uterine depressor	289	tonsil knife and dissector	235	DEBAKEY Bulldog Atrauma	41
breaker, CASTROVIEJO blade	13	case, GUYON dilating,		DESJARDINS common duct	54
blade	13	complete set	270	FINOCHIETTO bronchial	254
TROUTMAN CHRIS blade	13	needle	308	GLOVER vascular atrauma	41
VIRCHOW skull	124	SAUERBRUCH needle	308	GRAY common duct	54
WOLFF plaster cast	108	case steel	308	GUYON pedicle	55
BREISKY speculum	282	suture clip set	105	HARRINGTON bronchus	254
broad bone plates	158	tracheostomy set	246	HERRICK pedicle	56
BROWN ADSON forceps	35	CASPAR blades	80,82	KANE umbilical cord	303
BRUENINGS ear speculum		hook	81	LAHEY bronchus	254
pneumatic	198	laminectomy spreader	81	LAMBERT LOWMAN	
extension tubes	240	lumbar vertebral speculum	82	bone holding	118
forceps tips	240	retractors	80,82	LOWMAN bone holding	118
nasal cutting forceps	215	soft tissue spreader	80	LURZ ureter	258
septatome	221	CASTANEDA ALU spreader	252	MAYO GUYON pedicle	55
tongue depressor	230	CASTROVIEJO blade breaker	13	MOYNIHAN	54
tonsil snare	237	capsular forceps	193	PAYR stomach crushing	266
BRUNETTI spine chisel	124	corneal scissors	33	PRICE THOMAS bronchus	254
BRUNNER conductor	100	cyclodial. spatula	184,185	SAROT bronchus	51,255
intestinal forceps	263	eye speculum	179	SATINSKY anastomosis	255
ligature conductor	100	fixation forceps	192	SEMB bronchus	255
rib shears right	249	iridectomy scissors	32	STILLE pedicle	55
BRUNS bandage scissors	30	keratome	180	STOCKMANN penile	270
bone curettes	119,120	lachrymal dilator	186	STRAUSS penile	270
BRYANT swab forceps	62	marker	185	tubing	58
BUCHWALD tongue depressor	230	needleholder	97	CLAR head lamps	4
BUCK ear curettes	201	suturing forceps	194	CLARK eye speculum	178
ear knife	202	trephine	196	CLEVELAND rongeur	109
hammer	6	cataract needles	181	clip applying forceps YASARGIL	177
lever foreign bodies	204	catheter, COXETER prostate	271	clip carrier brain	166
BUIE aspirating cannula	275	HARTMANN ear	202	JONES towel	59
SMITH rectal spreader	273	ITARD ear	202	RANEY scalp hemostasis	167
bulb for CLAR lamp	4	catheter metal female, male	271	SCHAEDEL towel	59
BUMM uterine curettes	299	cautery, WADSWORTH TODD	184	YASARGIL, aneurysma	176,177
BUNGE exenteration scoops	183	cephalometer, BERTILLON	7	clips, MICHEL	104
BUNNELL bone hand drill	135	CHAPUT hemostatic forceps	47	silver brain suture	266
tendon strippers	132	CHARRIERE amputation saw	133	WACHENFELDT	104
BUNT safety needle	105	CHEATLE steriliz. forceps	105	CLOWARD blades	79
BURCH fixation fork	181	cheek retractor	231	retractor	79
LISTER eye speculum	178	CHERON dressing forceps	62	spreader vertebrae	171
BURKE biopsy punch	294	CHEVALIER JACKSON forceps	241	COAKLEY antrum curettes	228

	Page		Page		Page
antrum trocar	90	TITAN hemostatic forceps	45	dura dissector	169
COLCLOUGH punches	175	WOOD needleholder	92	forceps for syringes	
COLLIER needleholder	92	CRITCHETT eye speculum	178	and needles	105
COLLIN abdominal retractors	86,87	CRUTCHFIELD drill bit	167	foreign body needle	181
clip forceps	104	traction tongs	167	DAY ear hooklets	203
dressing forceps	62	CULLER iris spatula	184	DE BAKEY needleholders	93
DUVAL forceps	36	curette, ALVIS foreign body	182	de LEE obstetric forceps	300
dynamometres	2	AXENFELD chalazion	183	De MARTEL saw conductor	169
hammer	125	BARNHILL adenoid	229	POTTS vascular scissors	23
HARTMANN retractor	65	BECKMANN adenoid	229	DEAN iris knife	180
hemostatic forceps	47	BLAKE double uterine	297	tonsil scissors	23
pelvimeter	303	BRUNS bone	119,120	DEAVER grip retractor	67
scalpel handle	10	BUCK ear	201	retractor	67
speculuma vaginal	276	BUMM uterine	299	scissors	19
tongue holding forceps	231	COAKLEY antrum	228	DEBAKEY Atrauma forceps	40
umbilical cord clamp	303	FAULKNER sharp	228	Bulldog clamp Atrauma	41
uterine elevating forceps	288	FOX lupus	306	vascular/thorax scissors	24
uterine sound	289	HALLE bone	120	DEJERINE hammer	6
COLLYER pelvimeter	303	HEBRA chalazion	183	DeMARTEL WOLFSON	
COLVER tonsil seizing forceps	236	HOUSE ear	211	anastomosis forceps	264
combination diagnostic set	3	KEVORKIAN biopsy	290	DeMARTEL WOLFSON	
comedo extractor, SCHAMBERG	306	LEMPERT bone	120	clamp holder	264
UNNA	306	MARTINI bone	120	DeMARTEL WOLFSON	
compression apparatus complete	132	MEYHOEFER chalazion	183	closing forceps	264
compression screw	151	NOVAK aspiration biopsy	290	DENHART mouth gag	231
conductor, BRUNNER ligature	100	PESTALOZZA abortion	304	depressor, DAVIS BOYLE tongue	232
De MARTEL saw	169	PIFFARD lupus	306	KILNER DOUGHTY tongue	233
KIRSCHNER ligature	100	RANDALL aspiration biopsy	290	DERF needleholders	92
KOENIG ligature	100	RECAMIER uterine	299	dermatome, SCHINK	15
MILLIN ligature	267	SCHEDE bone	119	DESCHAMPS needles	98
PAYR ligature	100	SIMON bone	120	DESJARDINS common duct clamp	54
SCHMIEDEN ligature	100	SIMS uterine	299	gall stone forceps	256
SCHMIEDEN PAYR ligature	100	SPRATT bone	119	gall stone scoop	257
condylar plate	159,160	StCLAIR THOMSON	229	gall stone probe	257
CONNIN AMSLER marker	185	VOLKMANN bone	119,120	DESMARRES chalazion forceps	195
CONVERSE knife nasal plastics	220	WILLIGER bone	120	retractor (eyelid)	69
COOLEY Atrauma forceps	40	CUSCO specula vaginal	276,277	DEUTSCHMANN cataract knife	179
COOPER needle	98	CUSHING brain spatula	171	DeVILBISS skull forceps	169
CORDESS forceps tip	240	flat burr	134	DEWEY forceps	302
corticalis screws	153,154	forceps thumb and tissue	35	Diamant wire cutter	142
corticalis sinker	145	forceps laminectomy	172	DIEFFENBACH serrefine	42
CORWIN tonsil hemostat	237	nerve hook	168	DIETER malleus nippers	206
CORYLLOS retractor (thorax)	75	retractors	69	DIETHRICH needleholder	96
rib shears	249	cuticle nipper	307	dilator, CASTROVIEJO lachrymal	186
COS forceps wire bending	206	cuticle scissors	307	GOODELL uterine	285
COTTLE chisel nasal plastics	223	cutter, Credo corn	307	HANK uterine	285
KAZANJIAN bone		Diamant wire	142	HEGAR uterus	283,284
cutting forceps	113	finger ring	133	LABORDE tracheal	245
knife nasal plastics	220	ligature	244	SIMS uterine	285
nasal specula	213	McKENZIE for HUDSON brace	134	TROUSSEAU tracheal	245
nasal scissors	23	wire	142	WILDER lachrymal	186
NEIVERT retractor	227	CUZZI abortion scoop	304	WYLIE uterine	285
periosteal elevator	222	cystotome, BECKER	182	ZIEGLER lachrymal	186
retractor	227	GRAEFE	182	bandage scissors	
septum elevator	222	CZERNY rectal speculum	272	eccentric	30
cotton applicator	89	DANDY hemostatic forceps	46	blade breaker	13
COXETER catheter prostate	271	nerve hook	168	cotton applicators	89
CRAFOORD lung (thorax) scissors	27	neurosurgical scissors	27	eye magnet with loop	197
cranioclast, BRAUN	305	DARLING spreader	79	finger ring cutter	133
TARNIER	305	DARTIGUES uterus		pocket kit standard	105
Credo corn cutter	307	elevating forceps	288	retractors	76
Credo spare blades	307	DASTOOR erisophake	185	tuning forks	199
CRILE hemostatic forceps	45	strabismus forceps	190	DINGMANN bone holding forceps	117
MURRAY needleholder	92	DAVIDSON (scapula) retractor	75	director, DOYEN grooved	88
needleholder	94	DAVIEL cataract spoon	183	grooved	88
RANKIN hemostatic forceps	45	DAVIS BOYLE mouth gag	232	KOCHER goitre	247
retractor	65	BOYLE tongue depressor	232	disc to limit cut depth	138

	Page		Page		Page
dish, PETRI	310	electric plaster saw	107	file, bone, and rasp	132
disposable scalpels sterile	12	electrodes for HF		JOSEPH bone	224
dissector, DAVIS dura	169	coagulation	314,315	nail	307
dura	169	elevator, ADSON	128	finger bandage scissors,	
FISCH	211	BALLENGER septum	222	KNOWLES	30
GREEN corneal	182	COTTLE periosteal	222	finger nail perforator	133
HORSLEY dura	170	COTTLE septum	222	plates	162,163
HURD tonsil	235	FREER septum	221	protector LANGENBECK	234
LANG lachrymal sac	184	HAJEK BALLENGER septum	222	finngerring saw forceps	133
MILLIGAN dura	169	HENKE tonsil	235	FINOCHIETTO ALU infant	
PATON corneal	181	JOSEPH periosteal	222	rib spreader	250
PENFIELD	170	KEY	128	ALU rib spreader	250
SACHS dura	169	KILLIAN septum	222	BURFORD ALU rib spreader	251
TOENNIS dura	169	LANGENBECK	128	BURFORD rib spreader	251
DIX foreign body spud	182	LEMPERT	211	baby rib spreader	250
needle and gouge, spud	185	McDONALD	129	bronchus clamp	254
DOUGLAS BOZEMANN		McKENTY septum	221	needleholders	94
swab forceps	63	MURPHY LANE	129	spreader, rib	250
cilia forceps	197	ROGER septum	221	FINSEN retractors	76
trocár and cannula	90	WATSON CHEYNE	129	FISCH dissectors	211
DOYEN abdominal retractor	74	ELLIOT obstetric forceps	300	FISCHER iris forceps	189
baby intestinal forceps	260	trephines	197	flat nose pliers	141
conical burr	137	ELLIS foreign body gouge	182	FLEURANT trocar for bladder	90
costal periosteal	127	ELSCHNIG capsular forceps	193	FOERSTER iris forceps	188
cylindrical burr	137	corneal knife	181	swab forceps	61
grooved director	88	cyclodialysis spatula	184	FOMON alar retractor	227
gynecological scissors	25	fixation forceps	192	chisel	223
intestinal forceps	260	EMMET fistula hook	296	nasal rasps	225
JANSEN (MOLT) mouth gag	231	ENGEL plaster cast saw	106	nasal scissors	22
myoma screw	296	engine, bone surgery	136	retractor posterior nares	227
speculum vaginal	281	enterotomy scissors	28	forceps, ADLERKREUTZ	36
spherical burrs	137	enucleation scissors	22	ADSON	35
towel forceps	59	EPPENDORFER biopsy punch	295	ADSON baby hemostatic	48
uterus polypus forceps	288	KEVORKIAN biopsy punch	296	ADSON BROWN	35
dressing forceps	34-37	punches square and oval	296	ADSON hemostatic	48
drill, bone flat	137	TISCHLER MORGAN punch	296	ADSON micro	35
BUNNELL bone hand	135	erisophake, DASTOOR	185	ADSON pituitary	170
drill cannulated	145	ESMARCH bandage scissors	30	ALEXANDER biopsy	292
CRUTCHFIELD bit	167	plaster knife	108	ALLIS ADAIR	259
MOORE bone hand	134	EVES tonsil snares	237	ALLIS baby tissue	259
RALK bone hand	135	extension bow	140	ALLIS tissue	259
STILLE bone hand	134	extension hooks	140	ARCHER splinter	38
STILLE SHERMAN bone hand	134	extraction hook	143	ARRUGA capsular	193
TOTI	137	extractor, KUENTSCHER	143	ASCH septum straightening	228
twist	134	SAALFELD comedo	306	AYER chalazion	195
driver, KUENTSCHER nail	143	WALTON comedo	306	BABCOCK	259
LANE screw	144	FARABEUF		BACKHAUS towel	59
screw with hexagonal recess	144	bone holding forceps	114	BAINBRIDGE hemostatic	53
DUBOIS gynecological scissors	25	LAMBOTTE		BALLENGER tonsil seizing	237
DUPLAY tenaculum forceps	286	bone holding forceps	115	BARRAQUER anterior chamber	191
Duplex stethoscope	5	periosteal	126	BARRAQUER cilia	197
DUPUY WEISS tonsil needle	236	retractor double pair	64	BARRAQUER fixation	192
dura dissector	169	FARREL cotton applicators	89	BARRAQUER KATZIN iris	189
DUVAL COLLIN forceps	36	FAULKNER curette sharp	228	BARRAQUER Colibri iris	189
forceps	36	FAURE peritoneum forceps	56	BARRETT tenaculum	286
grasping forceps	260	uterine biopsy forceps	291	BARTON obstetric	301
dynamometres, COLLIN	2	FEHLAND intestinal forceps	263	BEER cilia	197
ear forceps	204-209	FEILCHENFELD splinter forceps	38	BENGOLEA hemostatic	48
forceps micro	205-209	female catheter metal	271	BERKE muscular	191
loop, BILLEAU	203	FERGUSON angiotribe	46	BERNHARD towel	59
olive	201	bone holding forceps	114	BEST intestinal	263
snare KRAUSE polypus	203	gall stone scoop	257	biopsy coagulating	243
snare WILDE polypus	203	FERRIS SMITH KERRISON		biopsy flexible	242
ECHLIN bone rongeur	112	punches	174	bipolar coagulation	316-318
Econom blood pressure apparatus	1	SMITH forceps	36	BIRCHER GANSKE	
Econom universal diagnostic set	3	SMITH forceps laminectomy	173	bone holding	117
electric bone engine	136	ferrule, locking, STONE WATT	263	BISHOP HARMAN iris	190

	Page		Page		Page
BLAKE gall stone	256	FARABEUF LAMBOTTE		KELLY RANKIN hemostatic	45
BLOHMKE tonsil seizing	237	bone holding	115	KELLY TITAN hemostatic	45
BOEHLER bone cutting	113	FAURE peritoneum	56	KELLY uterus polypus	288
BOERMA obstetric	302	FAURE uterine biopsy	291	KERN bone holding	115
BONACCOLTO strabismus	190	FEHLAND intestinal	263	KEVORKIAN biopsy	293
bone holding	114-118	FEILCHENFELD splinter	38	KIELLAND LUIKART obstetrical	301
Bonn iris	190,191	FERGUSSON bone holding	114	KIELLAND obstetrical	300
BOZEMANN DOUGLAS swab	63	FERRIS SMITH	36	KIRBY ARTHUR.iris	189
BOZEMANN swab	63	FERRIS SMITH laminectomy	173	KNAPP LUER trachoma	195
BRAUN tenaculum	286	fingerling saw	133	KNIGHT nasal cutting	215
BROWN tissue	35	FISCHER iris	189	KOCHER hemostatic	45
BRUENINGS nasal cutting	215	forceps flexible	242-244	KOCHER intestinal	261
BRUNNER intestinal	263	FOERSTER iris	188	LAHEY common duct	53
BRYANT swab	62	FOERSTER swab holding	61	LAHEY goitre seizing	247
CARMALT splinter	38	foreign body	244	LAMBERT chalazion	195
CASTROVIEJO capsular	193	FRAENKEL laryngeal polypus	239	LAMBOTTE bone holding	115
CASTROVIEJO fixation	192	FUCHS capsular	193	LANE	36
CASTROVIEJO suture	194	GAUSS scalp flap	303	LANE bone holding	115
CHAPUT hemostatic	47	GELLHORN biopsy	292	LANE for bone plates	144
CHEATLE sterilizing	105	Gemini dissecting/ligature	49	LANE for bone screws	144
CHERON dressing	62	Gemini mini dissecting/ligature	49	LANE stomach clamp	265
CHEVALIER JACKSON	241	GERALD thumb and tissue	37	LANE towel	59
CHILDE grasping	104	GILL ARRUGA capsular	192	LANGENBECK bone holding	114
cilia	197	GILL HESS iris	188	LAWRENCE	
COLLIN	104	GILL iris	188	hemost./diss./ligature	52
COLLIN dressing	62	GILLIES	37	LERCHE	36
COLLIN DUVAL	36	GRADLE cilia	197	LERICHE hemostatic	48
COLLIN hemostatic	47	GRAEFE	35	LESTER fixation	192
COLLIN tongue holding	231	GRAEFE fixation	192	LEWIN bone holding	117
COLLIN uterine elevating	288	GRAEFE iris	186,187	LISTER (sinus) swab	62
COLVER tonsil seizing	236	GREEN ARMYTAGE		LITON bone cutting	113
COOLEY Atrauma	40	uterine hemostatic	303	LITTAUER cilia	197
COTTLE KAZANJIAN		GREEN fixation	192	LITTAUER ear	204
bone cutting	113	grip (seizing) for wire drills etc	141	LITTAUER nasal polypus	215
CRILE hemostatic	45	GROSS MAIER dressing	60	LORNA towel	59
CRILE RANKIN hemostatic	45	HALSTED micro mosquito	43	LOVE GRUENWALD	
CRILE TITAN hemostatic	45	HALSTED mosquito	43	laminectomy	172
CUSHING laminectomy	172	HALSTED TITAN mosquito	43	LOVELACE hemostatic	46
CUSHING thumb and tissue	35	HARTMANN ear	204	LOVELACE lung grasping	254
DANDY hemostatic	46	HARTMANN hemostatic	42	LOWER common duct	53
DARTIGUES uterine elevating	288	HARTMANN HOFFMANN ear	204	LUBET BARBON nasal polypus	215
DASTOOR strabismus	190	HARTMANN nasal cutting	217	LUC nasal cutting	216
de LEE obstetric	300	HARTMANN nasal polypus	214	LUCAE ear	203
DEBAKEY Atrauma	40	HARTMANN WULLSTEIN ear	204	LUIKART obstetric	301
DeMARTEL WOLFSON		HAUGH ear	206	MAGILL catheter introducing	8
anastomosis	264	HEANEY hysterectomy	57	MARSCHIK tonsil	237
DeMARTEL WOLFSON closing	264	HEGENBARTH clip applying	104	MARTEL scalp flap	47
DESJARDINS gall stone	256	HEISS hemostatic	48	MARTIN cartilage holding	117
DESMARRES chalazion	195	HESS capsular	193	MARTIN muscular	247
DeVILBISS skull	169	HESS iris	188	MATHIEU foreign body	269
DEWEY	302	HEYMANN KNIGHT nasal	215	MAYO BLAKE gall stone	256
DINGMANN bone holding	117	HEYMANN nasal cutting	215	MAYO ROBSON intestinal	262
DOUGLAS cilia	197	HEYWOOD SMITH pile	275	McCULLOUGH strabismus	189
DOYEN intestinal	260	HUNTER splinter	38	McINDOE serrated	36
DOYEN towel with ring	59	IOWA vulsellum	287	McKENZIE clip applying	166
DOYEN uterus polypus	288	JACKSON tampon	239	McLEAN LUIKART obstetrical	301
forceps dressing	34	JACOBS vulsellum	287	McLEAN obstetrical	301
DUPLAY tenaculum	286	JAMESON strabismus	189	McLEAN TUCKER LUIKART	
DUVAL	36	JANSEN nasal	214	obestetrical	301
DUVAL grasping	260	JARCHO tenaculum	286	McLEAN TUCKER obstetrical	301
ear	204-209	JATHO nasopharyngeal cutting	228	McPHERSON tying	194
ear micro	205-209	JOHNS HOPKINS		MEEKER	
ELLIOT obstetric	300	hemost./common duct	53	hemost./dissect./ligature	52
ELSCHNIG capsular	193	JUDD ALLIS	259	MICHEL clips applying	104
ELSCHNIG fixation	192	JURASZ laryngeal polypus	239	MICHEL combined	
FARABEUF		KALT capsular	193	clip appl./removing	104
bone holding	114	KELLY hemostatic	45	microsurgical	39



	Page		Page		Page
MIDDLETON JANSEN cutting	219	sequester	117	WITTNER biopsy	293
MIKULICZ peritoneum	56	SIMPSON BRAUN obstetrical	300	WRIGLEY obstetrical	300
MILLIN capsule grasping	267	SIMPSON LUIKART obstetrical	301	YEOMAN rectum biopsy	275
MILLIN prostatic lobe holding	267	SIMPSON obstetrical	300	YOUNG prostatic	267
MIXTER baby hemostatic	52	SINGLEY	37	YOUNG tongue holding	231
MIXTER common duct	54	SKENE tenaculum	286	ZENKER dissecting/ligature	51
MIXTER gall stone	256	SMITHWICK clip applying	166	FORD BOWLES stethoscope	5
MIXTER		SNELLEN entropium	195	stethoscope	5
hemost./bronch./common duct	53	SOMER uterine elevating	288	FOREGGER laryngoscopes	9
MIXTER hemost. and bronchus	52	SPENCER WELLS hemostatic	46	foreign body forceps	244
MIXTER O'SHAUGNESSY	53	splinter	38	foreign body needles	181
MOORFIELD suture	194	splinter with mangifier	38	fork, BURCH fixation	181
MOYNIHAN towel	59	SPURLING laminectomy	172	tuning	199
MUSEUX vulsellum	287	St. MARTIN suture	194	HARTMANN tuning	199
NAEGELE obstetrical	300	STAUDE MOORE tenaculum	286	LUCAE tuning	200
forceps narrow	34	sterilizing	105	RYDEL SEIFFER tuning	200
forceps narrow dressing	34	STEVENS iris	187	FOX lupus curette	306
NEGUS tonsil hemostatic	236	STIEGLITZ splinter	38	FRAENKEL forceps tip	240
NELSON tissue	37	STILLE thumb and tissue	34	laryngeal polypus forceps	239
NOTO uterus polypus	288	STILLE HORSLEY bone cutting	114	FRANCESCHETTI trephine	196
OLDBERG laminectomy	173	STILLE LISTON bone cutting	113	FRANCIS foreign body needle	181
OLIVECRONA TOENNIS		STONE closing	263	FRANKE blood lancet	2
clip applying	166	STONE WATT intestinal	263	FRANKLIN SILVERMANN	
PAUFIQUE TITAN tying	194	STRUEMPPEL ear	204	biopsy needle	91
PAUFIQUE tying	194	STRUYCKEN nasal	217	SILVERMANN split needle	91
PEAN hemostatic delicate	45	SWEET clip applying	166	FRAZIER aspirating cannula	171
PEAN hemostatic	47	TARNIER	302	chordotome	170
PEET splinter	38	TEALE vulsellum	287	hooklet (dura)	68
PELKMANN dressing	62	TERSON capsular	193	puncture cannula	171
PENNINGTON hemostatic	46	THOMS ALLIS	259	spreader	83
PHANEUF peritoneum	56	THOMS GAYLOR biopsy	292	FREER septum knife	220
PIPER obstetrical	302	TILLEY ear	204	FREER gouge	224
POTTS SMITH thumb and tissue	34	TISCHLER MORGAN biopsy	293	mucosa knife	220
PRATT hemostatic	47	forceps tissue	34	septum chisel	222
PRATT vulsellum	287	TIVNEN tonsil seizing	237	septum elevator	221
PRINCE muscular	191	TOENNIS hemostatic	50	FRENZEL tongue depressor	230
PROVIDENCE HOSPITAL		TROELTSCH nasal dressing	214	FRIEDMAN rongeurs	109
hemostatic	44	TROUTMAN Coiibri iris	189	retractor perineorrhaphy	282
RADOLF nail extracting	133	TROUTMAN rectus muscle	191	FRITSCH retractor	73
RAMPLEY swab holding	61	Tübingen TITAN iris	191	FRYKHOLM bone rongeur	112
RANDALL kidney stone	258	Tübingen iris	191	FUCHS capsular forceps	193
RANEY applying and removing	167	Tübingen tying	194	GALLAHER antrum rasps	226
RICHTER HEATH clip applying	104	TUFFIER hemostatic	47	GAUSS scalp flap forceps	303
ROBERTS hemostatic	50	TURREL rectal biopsy	275	GELLHORN biopsy forceps	292
ROCHESTER CARMALT		TYDING tonsil seizing	237	GELPI perineal retractors	86
hemostatic	46	ULRICH swab holding	60	Gemini dissecting/ligature forceps	49
ROCHESTER OCHSNER		universal seizing	105	GERALD forceps	37
hemostatic	45	forceps USA patterns	34	GERSTER traction bar	118
ROCHESTER PEAN hemostatic	45	VAN BUREN sequester	117	GERZOG hammer	125
ROEDER towel	59	van DOREN biopsy	292	GIERTZ STILLE rib shears	249
ROGGE sterilizing	105	VERBRUGGE bone holding	116	GIGLI handle for wire saw	169
ROWE disimpaction	234	VIRTUS (RALK) splinter	38	GILL ARRUGA capsular forceps	192
RUBIN septum crushing	217	WACHENFELDT clip applying	104	corneal knife	181
RUSKIN LISTON bone cutting	113	WAGNER laminectomy	173	iris forceps	188
forceps Russian pattern	36	WALSHAM		GILLIES forceps	37
SAENGER placenta and ovum	304	septum straightening	228	hooklet	227
SAWTELL tonsil hemostatic	236	WANGENSTEEN	37	needleholder with scissors	95
SCHNIDT tonsil hemostatic	236	watchmaker's	38	glass boxes	308,309
SCHOENBURG grasping	260	WEIL BLAKESLEY	216	GLOVER clamp vascular atrauma	41
SCHROEDER tenaculum	286	WERTHEIM CULLEN		GLUCK rib shears	248
SCHROEDER vulsellum	287	hysterectomy	57	GOELET retractor double	65
SCHUBERT biopsy	291	WERTHEIM hysterectomy	57	GOLDSTEIN eye speculum	179
SCHUMACHER biopsy	293	WILDE TROELTSCH ear	203	goniometer, MOELTGEN	7
SCHWEIGGER capsular	193	WILLET MARTEL scalp flap	47	GOOD tonsil scissors	23
SEMB bone cutting	114	WILLIAMS grasping	260	GOODELL uterine dilator	285
SEMB bone holding	114	WINTER placenta and ovum	304	GOSSET abdominal retractor	83
SEMKEN thumb and tissue	37	wire cutting and bending	141	gouges	121-123,224



	Page		Page		Page
gouge, ALEXANDER	121	dura knife	170	HEGENBARTH	
DIX and needle	185	HARTMANN speculum nasal	212	clip applying forceps	104
ELLIS foreign body	182	TIECK speculum nasal	213	HEIFETZ brain spatula malleable	171
FREER	224	HALSEY needleholders	92	HEISS hemostatic forceps	48
HAJEK V-shape	224	HALSTED micro mosquito forceps	43	HEISTER mouth gag	231
HIBBS	123	mosquito forceps	43	hemostat, CORWIN tonsil	237
KILLIAN CLAUS V-shape	224	TITAN mosquito forceps	43	PASSOW	211
LEXER	123	Hamburg cannula buttoned	196	HENKE tonsil elevator	235
PARTSCH	121	hammers	125	HENNIG plaster spreader	108
SMITH PETERSEN	122	hammer, BABINSKY	6	HERRICK pedicle clamp	56
STILLE	121	BERLINER	6	HESS capsular forceps	193
WALTON foreign body	182	BUCK	6	GILL iris forceps	188
GRADLE cilia forceps	197	COLLIN	125	iris forceps	188
graduated measure	310	DEJERINE	6	HEYMANN KNIGHT nasal forceps	215
rulers	7	GERZOG	125	nasal cutting forceps	215
GRAEFE cataract knives	179	KIRK	125	nasal scissors	22
cataract spoon	183	hammer lead filled	125	HEYWOOD SMITH pile forceps	275
cystotome	182	LUCAE	125	HIBBS bone chisel	123
eye speculum	178	QUISLING intranasal	125	gouge	123
fixation forceps	192	slotted	143	osteotome	123
forceps	35	TAYLOR	6	HIRSCHMANN anoscope	274
hooklets (iris)	68	TRAUBE	6	HOESEL needleholder	95
iris forceps	186,187	TROEMNER	6	HOFER pillar retractor	235
scarifier	180	WILLIGER	125	HOHMANN bone levers	129,130
strabismus hooks	182	hammer with hook handle	125	mini bone lever	130
TITAN strabismus hooks	182	hand drill with		HOKE chisels	123
GRAHAM nerve hook	168	telescopic wire guide	135	HOLTH corneoscleral punch	185
grasper, polypus,		hand, lead, adult and child sizes	118	hook, ARRUGA extracting	182
endoscopic, flexible	244	handle, BARTON traction	301	BOSE trachea sharp	245
GRAVE speculum vaginal	276	battery, for laryngoscopes	9	BRAUN decapitation	305
speculum laser model vaginal	276	battery with coldlight, f. laryng	9	CASPAR	81
GRAY common duct clamp	54	BILL traction	302	CUSHING nerve	168
GREEN ARMYTAGE		brain knife	16	DANDY nerve	168
uterus hemost. forcep	303	COLLIN scalpel	10	EMMET fistula	296
corneal dissector	182	handle for laryngeal mirrors	241	extraction	143
fixation forceps	192	handle for vein stripper	89	GRAEFE strabismus	182
muscular hook	182	HUBER universal	240	GRAEFE TITAN strabismus	182
retractor	72	handle laryngeal mirrors	241	GRAHAM nerve blunt	168
SENN retractor	69	scalpel	10	GREEN muscular	182
GREVEN forceps wire bending	206	handle with Jacobs chuck	136	GROSS ear and spoon	202
grip (seizing) forceps	141	HANK uterine dilators	285	ITERSON trachea	245
grooved director	88	HARMTANN ear specula	198	JACKSON trachea	245
GROSS ear spoon and hook	202	HARRINGTON bronchus clamp	254	JAMESON strabismus	182
MAIER dressing forceps	60	retractor	67	Nail	146
GRUBER ear specula	198	HARTMANN COLLIN retractor	65	O'CONNOR iris	182
guide, hand drill telescopic	135	ear catheter	202	PRATT cystic	274
guide pin	143	ear forceps	204	ROSE trachea double end	246
telescopic for bone wires	135	HALLE speculum nasal	212	SACHS nerve	168
gum scissors	29	hemostatic forceps	42	SMELLIE obstetrical	303
GUTHRIE double hooklets	68	HOFFMANN ear forceps	204	SMITHWICK nerve	168
GUTMANN secretion scoop	270	nasal cutting forceps	217	STEVENS lens	182
GUYON dilating bougies	270,271	nasal polypus forceps	214	WIENER iris	182
mandrel for rubber catheter	270	tongue depressor	230	hooklet	211
MAYO pedicle clamp	55	tuning forks	199	hooklets, BARBARA	210
pedicle clamp	55	WULLSTEIN ear forceps	204	DAY ear	203
GUYTON LUNDGAARD		HAUGH ear forceps	206	FRAZIER (dura) sharp	68
sclerotome	181	head bands	4	GRAEFE (iris)	68
HABERER retractor malleable	66	HEANEY hysterectomy forceps	57	GUTHRIE double	68
HAGLUND STILLE		needleholders	93	JOSEPH mucous	68
plaster spreader	108	retractor	74	McGEE	211
HAIGHT rib spreader	252	HEATH ligature scissors	28	WAGENER buttoned	203
HAJEK BALLENGER		RICHTER clip forceps	104	hooks, extension	140
septum elevator	222	HEBRA chalazion curette	183	HOPKINS JOHNS	
CLAUS antrum punch	218	HEGAR dilators uterine	283,284	hemost./common duct forceps	53
gouge V-shape	224	MAYO needleholders	92	JOHNS serrefine	42
KOFLER punch	218	OLSEN needleholders	95	plaster knife	108
HALLE curette malleable shaft	120	uterus dilators	283,284	HORSLEY dura dissector	170

	Page		Page		Page
STILLE bone cutting forceps	114	speculum vaginal	280	ESMARCH plaster	108
hospital nurse set	307	KALT ARRUGA needleholder	97	FREEER septum	220
HOUSE curette	211	capsular forceps	193	FREER mucosa	220
HUBER universal handle	240	needleholder	97	GILL corneal	181
HUDSON brace	134	KANE umbilical cord clamp	303	GRAEFE cataract	179
HUNTER splinter forceps	38	KEITH suture needles	103	HALLE dura	170
HURD tonsil dissector	235	KELLY grip retractors	66	HOPKINS plaster	108
impactor, KUENTSCHER nail	143	gynecological scissors	25	KNAPP iris	180
impactor, nail, and extractor	142	hemostatic forceps	45	LANGENBECK resection	15
incision scissors	19	proctoscope	274	LISTON amputation	15
INGE spreader vertebrae	171	RANKIN hemostatatic forceps	45	MUCK periosteal	211
instrument, LAFORCE		retractor	66,74	PAUFIQUE keratoplasty	181
foreign body	182	TITAN hemostatic forceps	45	PLESTER flap	210
instrument tray	310	uterine polypus forceps	288	REINER plaster	108
interior box for needlecase	308	keratome, BERENS	180	ROSEN circular	210
intest. needles	103	CASTROVIEJO	180	SATO corneal	181
IOWA vulsellum forceps	287	JAEGER	180	SCHEIE goniotomy	181
iris scissors	21	KERN bone holding forceps	115	SCHUKNECHT roller	210
ISRAEL retractor	73	KERRISON punch	218	SCHUKNECHT sickle	210
ITARD ear catheter	202	KEVORKIAN biopsy forceps	293	SEGOND myoma	296
ITERSON trachea hooks	245	curette biopsy	290	SEXTON ear	202
IVES FANSLER anoscope	274	EPPENDORFER biopsy forceps	296	TABB sickle	210
JACKSON CHEVALIER forceps	241	Pacific biopsy punch	294	TOOK corneal	181
speculum	281	tips, biopsy	296	VIRCHOW cartilage	16
tampon forceps	239	TISCHLER punches	294,295	WHEELER discision	180
tracheostomy tubes	246	KEY elevator	128	WULLSTEIN sickle	210
trachea hooks	245	KEYES cutaneous punch	306	ZIEGLER capsulotomy	181
Jacobs chuck	136	kidney bowl	309	ZIEGLER iris	180
JACOBS vulsellum forceps	287	KIELLAND LUIKART		KNIGHT HEYMANN	
JAEGER keratomes	180	obstetrical forcep	301	nasal cutting forcep	215
lid plate	179	obstetrical forceps	300	KNOWLES bandage scissors finger	30
JAMESON strabismus forceps	189	KILLIAN CLAUS gouge V-shaped	224	KOCHER bladder retractor	268
strabismus hook	182	septum elevator	222	goitre directors	247
JAMISON needleholders	93	septum speculum	213	hemostatic forceps delicate	45
JANSEN DOYEN (MOLT)		wash cannula	219	intestinal forceps	261
mouth gag	231	KILNER DOUGHTY mouth gag	233	retractor	72,73
MIDDLETON cutting		DOUGHTY tongue depressor	233	KOENIG ligature conductor	100
forceps nasal	219	scissors	21	ROSER mouth gag	231
nasal forceps	214	skin retractor	306	suturing needles	103
retractors	76	KIRBY ARTHUR iris	189	KOERTE retractors	73
ZAUFAL rongeur	111	KIRK hammer	125	retractors	73
jars	310	KIRSCHNER abdominal retractors	85	KOGAN endo speculum	282
JARCHO tenaculum forceps	286	bow extension	140	KONRICH box for sterilization	311
JATHO nasopharyngeal		bow extension American	140	KRAUSE forceps tips	240
forceps cuttin	228	drill guide telescopic	135	nasal snare	219
JENNINGS mouth gag	232	ligature conductor	100	snare ear polypus	203
JEWETT nail	150	wiredrills	139	KRISTELLER	
JOBSON HORNE cotton applicator	89	kit, pocket		retractor vaginal	278-280
JOHNS HOPKINS		standard	105	specula vaginal	278-280
hemost./common duct	53	KLINKENBERGH LOTH		KRONECKER needle	98
HOPKINS serrefine	42	thorax scissors	27	KUENTSCHER extractor	
JOHNSON needleholder	94	KNAPP cataract spoon	183	f. intramed. nail	143
JONES towel clips	59	iris knives	180	medullary reamer	143
JOSEPH (LEWIS) nasal rasp	225	LUER trachoma forceps	195	nails	147,148
bone file	224	retractor	182	nail driver	143
knife nasal	220	knife, amputation	15	nail impactor	143
mucous hooklet	68	BALLENGER sviwel	221	reamer femur	143
nasal saws	227	BARKAN goniotomy	181	KUHNT corneal scarifier	181
periosteal elevator	222	BARRAQUER keratoplasty	181	LABORDE trachea dilator	245
plastic knives	220	BOWMAN discision	180	LAFORCE adenotome	229
scissors	21	BUCK ear	202	foreign body instrument	182
JUDD ALLIS forceps	259	CARPENTER and enucleator,		spare blade perforated	229
JUERS forceps wire bending	206	tonsill	235	Lag screw hip dynamic	151
JURASZ laryngeal		DEAN iris	180	LAHEY bronchus clamp	254
polypus forceps	239	DEUTSCHMANN cataract	179	common duct forceps	53
KABIERSKE powder blower	200,201	electrode for HF surgery	315	goitre seizing forceps	247
KALLMORGEN retractor vaginal	280	ELSCHNIG corneal	181	retractor	70

	Page		Page		Page
LAMBERT chalazion forceps	195	light, CLAR, head	4	St. suture forceps	194
LOWMAN bone holding clamp	118	lip and cheek retractor	231	uterine sounds	289
LAMBOTTE bone holding forceps	115	LISTER (sinus) swab forceps	62	MARTINI double curette	120
FARABEUF bone holding forceps	115	bandage scissors	30	MASSON JUDD bladder retractor	268
mini osteotome	122	BURCH eye speculum	178	needleholders	93
osteotome	122	LISTON amputation knife	15	MASTIN muscular forceps	247
periosteal	126	bone cutting forceps	113	MATHIEU foreign body forceps	269
lamp, spare for CLAR headlight	4	RUSKIN bone cutting forceps	113	needleholders	95
CLAR head	4	LITTAUER cilia forceps	197	rectal speculum	272
spare laryngoscope	9	ear forceps	204	retractor double pair	65
LANCASTER eye speculum	179	ligature scissors	28	MATSON ALEXANDER periosteal	128
lancet, electrodes	315	nasal polypus forceps	215	periosteal	128
FRANKE blood	2	LITTLE retractor	70	MAUNDER oral screw from wood	234
LANDAU speculum	282	LLOYD impactor/extractor	144	MAY ophthalmoscope	2
LANE bone holding forceps	115	loops ear, nasal	203,219	MAYO (HARRINGTON) scissors	19
bone plate wrench	144	loops, tonsil	237	BLAKE gall stone forceps	256
forceps thumb and tissue	36	LORENZ bandage scissors	30	gall stone scoop	257
forceps for bone plates	144	LORNA towel forceps	59	GUYON pedicle clamp	55
forceps for bone screws	144	LOUTE wire tightener/twister	141	HEGAR needleholders	92
MURPHY elevator double	129	LOVE GRUENWALD forceps lamnectomy	172	kidney stone probe	258
screw driver	144	nerve root retractor	168	NOBLE scissors	19
stomach clamp forceps	265	uvula retractor	235	ROBSON intestinal forceps	262
towel forceps	59	LOVELACE hemostatic forceps	46	safety needle	105
LANG lachrymal sac dissector	184	lung grasping forceps	254	scissors	19
LANGE forceps tip	240	LOWER gall duct forceps	53	STILLE scissors	19
LANGENBECK bone holding forceps	114	LOWMAN bone holding clamps	118	MAYO (HARRINGTON) scissors	19
elevator	128	LUBET BARBON nasal polypus forceps	215	McCULLOUGH strabismus forceps	189
finger protectors	234	LUC nasal cutting forceps	216	McDONALD elevator double	129
finger saw	133	LUCAE ear forceps	203	McGEE hooklets	211
periosteal	126	hammer	125	McGUIRE corneal scissors	32
resection knife	15	tuning forks	200	McINDOE cartilage scissors	27
retractor	71	LUER KNAPP trachoma forceps	195	McINDOE forceps serrated	36
laryngeal mirrors	241	rongeur	110	McINTOSH laryngoscopes	8,9
laryngoscope, FOREGGER	8,9	STILLE rongeur	111	McIVOR mouth gag	233
McINTOSH	8,9	tracheostomy tubes	246	McIVOR tongue depressor	233
LAWRENCE hemost./dissect./ligature forceps	52	LUIKART BILL tractor	302	McKENTY septum elevator	221
lead hand splints	118	KIELLAND obstetrical forceps	301	McKENZIE clip applying forceps	166
LEBSCHKE sternum chisel	124	McLEAN obstetrical forceps	301	McKENZIE cutter for HUDSON brace	134
LEGUEU bladder retractor	268,269	obstetrical forceps	301	McLAUGHLIN plate	149
LEKSELL (STILLE) rongeurs	112	SIMPSON obstetrical forceps	301	McLEAN LUIKART obstetrical forceps	301
LEMPERT curette	120	lumbar puncture needle	91	McLEAN obstetrical forceps	301
elevator	211	LUNDSGAARD GUYTON sclerotome	181	McLEAN TUCKER LUIKART obstetrical forceps	301
rongeur	110	sclerotome	181	McLEAN TUCKER obstetrical forceps	301
LERCHE forceps	36	LUNIATSCHKEK gauze packer	235	McPHERSON TITAN tying forceps	194
LERICHE hemostatic forceps	48	LURZ ureter clamps	258	McPHERSON tying forceps	194
LESTER fixation forceps	192	MAGILL catheter introducing forceps	8	MEAD hammer	125
lever, BENNETT bone	129	magnet, eye	197	rongeurs	109
BLOUNT bone	131	MAISONNEUVE urethrotome	269	measure graduated	310
bone	130	male catheter, metal	271	measure, tape	7
BUCK foreign bodies	204	malleolar screws	152,54	measuring probes	211
HOHMANN bone	129,130	MALTZ (COTTLE) nasal rasp	225	MEEKER hemost./dissect./ligature forceps	52
HOHMANN mini bone	130	mandrel, GUYON f. rubber catheters	270	MELLINGER AXENFELD eye speculum	178
QUIRE foreign bodies	204	manometre blood pressure apparatus	1	eye speculum	178
LEVINSON foreign body needle	181	marker, CASTROVIEJO	185	MENGHINI aspirating syringe	91
LEWIN bone holding forceps	117	CONNIN AMSLER	185	needle for liver puncture	91
LEXER baby scissors	20	MARSCHIK tonsil forceps	237	trocars for 2nd penetration	91
bone chisel	123	MARTEL De saw conductor	169	meniscotome, BIRCHER	131
gouge	123	scalp flap forceps	47	NEFF	131
mini chisel	123	WILLET scalp flap forceps	47	SMILLIE	131
mini gouge	123	MARTIN cartilage holding forceps	117	mercury blood pressure apparatus	1
scissors	20	pelvimeter	303		
LICHTWITZ antrum trocar needle	219				
antrum trocar	90				
ligature cutter	244				

	Page		Page		Page
MERCEDES thorax spreader	253	MUCK knife periostal	211	needleholder, ADSON	94
METZENBAUM fino scissors	20	MUELLER eye speculum	179	ARRUGA	96
needleholders	94	MURDOCK eye speculum	178	BARRAQUER	97
scissors	20,21	MURPHY LANE elevator double	129	BAUMGARTNER	92
MEYERDING retractor	70	muscle retractors	87	boomerang, YOUNG	99
MEYHOEFER chalazion curette	183	MUSEUX vulsellum forceps	287	BOYNTON	96
MICHEL clips	104	MYLES nasal cutting forceps	217	BOZEMANN	93
clips applying forceps	104	myrtle leaf probe	88	CASTROVIEJO	97
combined clip forceps	104	NABATOFF handle only	88	COLLIER	92
mirror postrhinoscopic	214	olive	88	CRILE	94
micro, BELLUCCI scissors	205	probe tip only	88	CRILE MURRAY	92
ear forceps	205	traction cable only	88	CRILE WOOD	92
micro forceps	39	varicous vein probe set	88	DE BAKEY	93
micro scissors	33,205,207	NAEGELE obstetrical forceps	300	DERF	92
micro scissors gynaecological	33	NAGER palate retractor	235	DIETHRICH	96
SHEA scissors	205	nail, BOEHLER	149	FINOCHIETTO	94
WULLSTEIN scissors	207	nail file	307	GILLIES with scissors	95
MIDDELDORPF retractor	72	nail hook	146	HALSEY	92
MIDDLETON JANSEN		nail impactor /extractor	142	HEANEY	93
cutting forceps	219	JEWETT	150	HOESEL	95
MIKULICZ peritoneum forceps	56	KUENTSCHER	147,148	JAMISON	93
retractor	74	nail nipper	307	JOHNSON	94
MILLIGAN dura dissector	169	nail scissors	307	KALT	97
MILLIN bladder neck spreader	269	SMITH PETERSEN	149	KALT ARRUGA	97
capsule forceps	267	narrow plates	157	MASSON	93
ligature conductor	267	nasal chisel WEST	224	MATHIEU	95
prostatic lobe holding forceps	267	nasal cutting forceps	217	MAYO HEGAR	92
mini clip applying		nasal gouge WEST	224	METZENBAUM	94
forceps YASARGIL	177	nasal knife CONVERSE, plastics	220	micro	96,97
BELLUCCI scissors ear	205	COTTLE plastics	220	NEIVERT	92
ear forceps	206-207,209	JOSEPH	220	OLSEN HEGAR	95
electrodes for coagulation	314,315	olive	201	RYDER	93
fragment plates	162	navicular Screw cannulated	152	SAROT	94
scissors	207	needle, BARBARA	210	STEVENS	96
screws cross slot	153	BOWMAN discission	181	STRATTE	94
WULLSTEIN scissors ear	207	needle cases	308	TOENNIS	94
miniclips, YASARGIL	176,177	cataract	181	WANGENSTEEN	93
mirror, laryngeal	241	COOPER	98	NEFF meniscotome	131
MICHEL, postrhinoscopic	214	DAVIS forceps f. syringes	105	NEGUS tonsil forceps	236
mirror replacement for headmirror	4	and needles	105	NEIVERT COTTLE retractor	227
ZIEGLER head	4	DAVIS foreign body	181	needleholder	92
MIXTER baby hemostatic forceps	52	DESCHAMPS ligature	98	NELSON forceps	37
common duct forceps	54	DUPUY WEISS tonsil	236	ligature needle	98
gall stone forceps	256	electrode	315	trocar thorax	90
hemost./bronchus/common		needle f. pudendus anesthesia	91	nerve preparation scissors	26
duct forc	53	foreign body	181	nipper, cuticle	307
hemostatic and bonchus forceps	52	FRANCIS foreign body	181	DIETER malleus	206
O'SHAUGNESSY forceps	53	FRANKLIN SILVERMANN	91	nail	307
MOELTGEN goniometer	7	intestinal suture	103	TURNBULL nail	307
MOLLISON spreader	79	KEITH suture	103	NORTHBENT (SPENCER)	
MOORE bone hand drill	134	KOENIG suture fish hook	103	ligature scissors	28
gall stone scoop	256	KRONECKER	98	NOTO uterus polypus forceps	288
STAUDE tenaculum forceps	286	LEVINSON foreign body	181	NOVAK aspiration curette	290
MOORFIELD suture forceps	194	LICHTWITZ antrum	219	NOYES iris scissors	32
mouth, DAVIS BOYLE gag	232	lumbar puncture	91	nasal polypus forceps	215
DENHART gag	231	MENGHINI liver puncture	91	nut for corticalis screws	155
DOYEN JANSEN (MOLT) gag	231	MENGHINI trocar		O'CONNOR iris hook	182
HEISTER gag	231	for 2nd penetration	91	O'SULLIVAN O'CONNOR	
JENNINGS gag	232	NELSON ligature	98	abdominal retractor	83
KILNER DOUGHTY gag	233	POLITZER paracentese	202	OCHSNER gall stone probe	256
McIVOR gag	233	REVERDIN ligature	99	ROCHESTER	
ROSER KOENIG gag	231	ROSEN	211	hemostatic forceps	45
SEEMANN SEIFFERT gag	232	suture	102,103	trocar thorax	90
WHITEHEAD gag	232	tonsil injection	238	OLDBERG forceps laminectomy	173
MOYNIHAN clamp	54	VERRES pneumoperitoneum	91	olive ear	201
gall stone probe	257	YOUNG spare for		olive nasal	201
towel forceps	59	boomerang needleholder	99	OLIVECRONA brain spatula	171

	Page		Page		Page
rongeur	110	PITHA mouth prop	234	KEYES	306
TOENNIS clip forceps	166	plaster shears	30	TISCHLER KEVORKIAN	294,295
wire saw	169	plaster spatula	89	TOWNSEND mini	294,295
OLLIER retractor	72	plaster spreaders	108	TOWNSEND oval bite	294
OLSEN HEGAR needleholder	95	Plate	151,156,161	TOWNSEND TISCHLER	
osteotomes	121-123	plate, angular, bone	160	MORGAN	294
osteotome, HIBBS	123	plate broad, bone	158	PUTTI bone rasp	132
LAMBOTTE	122	condylar	159	QUINBY gum scissors	29
STILLE	121	plate finger	162	QUIRE lever foreign bodies	204
otoscopy set	3	JAEGER lid	179	QUISLING hammer intranasal	125
OVERHOLT periosteal	128	McLAUGHLIN, femur	149	RADOLF nail extracting forceps	133
GEISSENDOERFER forceps	49	plate mini finger	163	RALK bone hand drill	135
packer, LUNIATSCHEK gauze	235	plate mini fragment	163	RAMPLEY swab forceps	61
parametrium scissors	24	plate mini	162	RANDALL aspirating curette	290
PARHAM band	118	plate narrow, bone	157	kidney stone forceps	258
band tightener	118	SHERMAN bone	164	RANEY applying and removing	
PARK eye speculum	179	skin straightening	15	forceps	167
PARKER retractor double pair	64	SMITH PETERSEN, bone	149	scalp hemostasis clip	167
scalpel	14	PLESTER flap knife	210	rasp, AUFRICHT nasal	224
PARTSCH bone chisel	121	retractors	76	bone	132
gouge	121	pliers, flat nose	141	FOMON nasal	225
PASSOW hemostat	211	POLITZER air bag	201	GALLAHER antrum fig	226
PATON corneal dissector	181	paracentese needle	202	JOSEPH (LEWIS) nasal	225
PAUFIQUE keratoplasty knife	181	polypus grasper	244	MALTZ (COTTLE) nasal	225
TITAN tying forceps	194	POOLE aspiration tube	8	PUTTI bone	132
tying forceps	194	post mortem set	124	WIENER (AUFRICHT) nasal	225
PAYR baby crushing clamp	266	POTTS DE MARTEL		WIENER antrum	225
intestinal crushing clamp	266	vascular scissors	23	razor blade for microsurgery	13
ligature conductor	100	SMITH forceps	34	razor knife	16
SCHMIEDEN ligature conductor	100	SMITH vascular scissors	24	reamer f. intramedullary pins	142
PEAN hemost. forceps delicate	45	powder blower KABERSKE	200,201	reamer, KUENTSCHER	143
hemostatic forceps	47	PRATT cystic hook	274	PERTHES square	138
ROCHESTER hemostatic		hemostatic forceps	47	reamers	138
forceps	45	rectal speculum	272	RECAMIER curettes uterine	299
PEDERSON speculum vaginal	276	vulsellum forceps	287	REICHERT epiglottis retractor	239
PEET splinter forceps	38	preparation scissors	26	REINER ear syringe	201
PELKMANN dressing forceps	62	PRICE THOMAS bronchus clamp	254	plaster knife	108
pelvimeter, COLLIN	303	PRINCE muscular forceps	191	replacement head band	4
COLLYER	303	tonsil scissors	23	mirror ZIEGLER	4
MARTIN	303	probe, BAKES gall stone	257	retractors	64-86
PENFIELD dissectors	170	BOWMAN lachrymal	186	retractor tracheal	68
PENNINGTON hemostatic forceps	46	probe buttoned	88	retractor, ADSON	77
PERCY retractor for amputation	133	DESJARDINS gall stone	257	ADSON baby	77
perforator, finger nail	133	MAYO kidney stone	258	ADSON dura	168
SMELLIE	305	measuring ear	211	ALM	76
periosteal, ALEXANDER	126	MOYNIHAN gall stone	257	AUFRICHT nasal	227
DOYEN costal	127	probe myrtle leaf	88	BALFOUR abdominal	84
FARABEUF	126	OCHSNER gall stone	256	BECKMANN	78
LAMBOTTE	126	STACKE ear	88	BECKMANN EATON	78
LANGENBECK	126	proctoscope, KELLY	274	BLOUNT knee	131
MATSON	128	prop, PITHA mouth	234	CASPAR	80,82
MATSON ALEXANDER	128	protector, ARRUGA	184	cheek Simplex	231
OVERHOLT	128	PROVIDENCE HOSPITAL		CLOWARD	79
SEDILLOT	126	hemostatic forceps	44	COLLIN abdominal	86
SEMB costal	127	pudendus, needle for anesthesia	91	CORYLLOS (thorax)	75
WILLIGER	126	punch, BAGGISH biopsy	295	COTTLE	227
PERTHES reamer	138	BEYER	218	COTTLE NEIVERT	227
PESTALOZZA abortion curette	304	BURKE biopsy	294	CRILE	65
PETRI dish	310	CITELLI	218	CUSHING	69
PHANEUF peritoneum forceps	56	COLCLOUGH	175	DEAVER	67
pick	211	EPPENDORFER biopsy	295,296	DESMARRES (eyelid)	69
PIERCE antrum trocar	90	FERRIS SMITH KERRISON	174	DOYEN abdominal	74
PIFFARD lupus curettes	306	HAJEK CLAUS antrum	218	FARABEUF double pair	64
pin, guide	143	HAJEK KOFLER	218	FINSEN	76
STEINMANN	139	HOLTH corneoscleral	185	FOMON alar	227
PINARD stethoscopes	5	KERRISON	218	FOMON posterior nares	227
PIPER obstetrical forceps	302	KEVORKIAN Pacific biopsy	294		



	Page		Page		Page
FRIEDMAN perineorrhaphy . . . . .	282	rib approximator . . . . .	253	needleholder . . . . .	94
FRITSCH . . . . .	73	rib shears . . . . .	248	SATINSKY anastomosis clamps . . . . .	255
GELPI perineal . . . . .	86	ribbon loop electrode . . . . .	315	thorax scissors . . . . .	27
GOELET double . . . . .	65	RIBBON retractor . . . . .	66	SATO corneal knife . . . . .	181
GOSSET abdominal . . . . .	83	RICHARDSON EASTMAN retractor . . . . .	66	SATTERLEE amputation saw . . . . .	133
GREEN . . . . .	72	retractor . . . . .	66	SAUERBRUCH bone rongeurs . . . . .	112
HARRINGTON . . . . .	67	RICHTER HEATH clip forceps . . . . .	104	FREY rib shears . . . . .	249
HEANEY . . . . .	74	RIGBY retractor . . . . .	86	needle case . . . . .	308
HOFER pillar . . . . .	235	ROBERTS hemostatic forceps . . . . .	50	retractor . . . . .	75
retractor hook-on, abdominal . . . . .	85	ROCHESTER CARMALT		rib shears . . . . .	249
ISRAEL . . . . .	73	hemostatic forcep . . . . .	46	saw, BERGMANN, plaster cast . . . . .	106
JUDD MASSON bladder . . . . .	268	OCHSNER hemostatic forceps . . . . .	45	saw blade, plaster cast . . . . .	107
JANSEN . . . . .	76	PEAN hemostatic forceps . . . . .	45	saw blade, amputating . . . . .	133
KALLMORGEN vaginal . . . . .	280	ROEDER towel forceps . . . . .	59	CHARRIERE amputation . . . . .	133
KELLY . . . . .	66,74	ROGER septum elevator . . . . .	221	circular, bone surgery . . . . .	138
KILNER skin . . . . .	306	ROGGE sterilizing forceps . . . . .	105	electric, plaster,	
KIRSCHNER abdominal . . . . .	85	ROLLET extirpation chisel . . . . .	182	oscillating . . . . .	107
KNAPP . . . . .	182	retractor . . . . .	182	ENGEL plaster cast . . . . .	106
KOCHER . . . . .	72,73	rongeur, bone, ADSON . . . . .	110	JOSEPH nasal . . . . .	227
KOCHER bladder . . . . .	268	BEYER . . . . .	111	LANGENBECK finger . . . . .	133
KOERTE . . . . .	73	BLUMENTHAL . . . . .	109	OLIVECRONA wire . . . . .	169
KRISTELLER vaginal . . . . .	278-280	BOEHLER . . . . .	111	SATTERLEE amputation . . . . .	133
LAHEY . . . . .	70	CLEVELAND . . . . .	109	WIGMORE plaster . . . . .	106
LANGENBECK . . . . .	71	ECHLIN . . . . .	112	SAWTELL tonsil forceps . . . . .	236
LEGUEU bladder . . . . .	268,269	FRIEDMAN . . . . .	109	SCAGLIETTI rongeurs . . . . .	112
lip and cheek . . . . .	231	FRYKHOLM . . . . .	112	scalpel blades sterile . . . . .	11
LITTLE . . . . .	70	LEMPERT . . . . .	110	scalpels disposable sterile . . . . .	12
LOVE nerve root . . . . .	168	LUER . . . . .	110	scalpel handles . . . . .	10
LOVE uvula . . . . .	235	MEAD . . . . .	109	scalpels . . . . .	14
MATHIEU double pair . . . . .	65	OLIVECRONA . . . . .	110	scalpel, PARKER . . . . .	14
MEYERDING . . . . .	70	RUSKIN . . . . .	111	scarifier, GRAEFE . . . . .	180
MIDDELDORPF . . . . .	72	SAUERBRUCH . . . . .	112	KUHNT corneal . . . . .	181
MIKULICZ . . . . .	74	SCAGLIETTI . . . . .	112	SCHAEDEL towel clip . . . . .	59
muscle . . . . .	87	SEMB . . . . .	113	SCHAMBERG comedo extractor . . . . .	306
NAGER palate . . . . .	235	STILLE LUER . . . . .	111	SCHEDE bone curettes . . . . .	119
O'SULLIVAN O'CONNOR		STILLE RUSKIN . . . . .	112	SCHEIE eye cannula . . . . .	196
abdominal . . . . .	83	ZAUFAL JANSEN . . . . .	111	SCHEINMANN forceps tip . . . . .	240
OLLIER . . . . .	72	ROSE trachea hook . . . . .	246	SCHIMMELBUSCH box,	
PARKER double pair . . . . .	64	ROSEN knife circular . . . . .	210	sterilizing . . . . .	311
PERCY for amputation . . . . .	133	needles . . . . .	210,211	SCHINK dermatome . . . . .	15
PLESTER . . . . .	76	ROSENBERG forceps tip . . . . .	240	SCHIOETZ tonometre . . . . .	197
REICHERT epiglottis . . . . .	239	ROSER KOENIG mouth gag . . . . .	231	SCHMIEDEN ligature conductor . . . . .	100
REVERDIN abdominal . . . . .	66	round bowl . . . . .	309	PAYR ligature conductor . . . . .	100
RIBBON . . . . .	66	ROUX baby retractor double . . . . .	64	TAYLOR dura scissors . . . . .	27
RICHARDSON EASTMAN . . . . .	66	mini retractor double . . . . .	64	SCHNIDT tonsil forceps . . . . .	236
RIGBY, rectum, vagina . . . . .	86	retractor . . . . .	64	SCHOENBORN thyroid retractor . . . . .	247
ROLLET . . . . .	182	ROWE forceps disimpaction . . . . .	234	SCHOENBURG grasping forceps,	
ROUX baby . . . . .	64	RUBIN septum crushing forceps . . . . .	217	intestinal . . . . .	260
ROUX . . . . .	64	rulers . . . . .	7	SCHROEDER tenaculum forceps . . . . .	286
ROUX mini . . . . .	64	RUMEL thorax forceps . . . . .	50	vulsellum forceps . . . . .	287
SAUERBRUCH . . . . .	75	RUSKIN LISTON bone		SCHUBERT biopsy forceps . . . . .	291
SENN . . . . .	66	cutting forceps . . . . .	113	SCHUKNECHT roller knife . . . . .	210
SENN GREEN . . . . .	69	bone rongeur . . . . .	111	sickle knife . . . . .	210
SIMON abdominal . . . . .	74	STILLE bone rongeur . . . . .	112	SCHULTZE salpingograph . . . . .	297
STERNBERG lip . . . . .	230	Russian pattern forceps . . . . .	36	SCHUMACHER biopsy forceps . . . . .	293
TAYLOR spinal . . . . .	131	RYDEL SEIFFER tuning fork . . . . .	200	forceps tip . . . . .	240
THOMSON WALKER bladder . . . . .	268	RYDER needleholder . . . . .	93	umbilical cord scissors . . . . .	26
US Army double pair . . . . .	65	SAALFELD comedo extractor . . . . .	306	SCHWEIGGER capsular forceps . . . . .	193
VOLKMANN . . . . .	69,70	SACHS dura dissector . . . . .	169	scissors, BARRAQUER colibri iris . . . . .	32
WEITLANER . . . . .	76	nerve hook . . . . .	168	BEEBEE, plate and wire . . . . .	29
WEITLANER WULLSTEIN . . . . .	76	SAENGER placenta and		BERGMANN bandage . . . . .	30
retractor with spring shaft . . . . .	68	ovum forceps . . . . .	304	BEUSE . . . . .	23
YOUNG prostatic . . . . .	267	safety needle BUNT . . . . .	105	BOETTCHER tonsil . . . . .	23
REVERDIN abdominal retractor . . . . .	66	needle MAYO . . . . .	105	BRAUN STADLER episiotomy . . . . .	26
needle, ligature . . . . .	99	salpingograph SCHULTZE . . . . .	297	BRUNS bandage . . . . .	30
REYNOLDS scissors . . . . .	21	SANVENERO scissors . . . . .	21	BUSCH umbilical cord . . . . .	26
rhachiotome . . . . .	124	SARQT bronchus clamps . . . . .	51,255	CASTROVIEJO corneal . . . . .	33

	Page		Page		Page
CASTROVIEJO iridectomy	32	obstetrical forceps	300	BODENHAMMER rectal	272
COTTLE nasal	23	SIMS curettes uterine	299	BOUCHERON ear	198
CRAFOORD lung (thorax)	27	rectal speculum	272	BOWMAN eye	178
cuticle	307	specula set vaginal	281	BREISKY vaginal	282
DANDY neurosurgical	27	speculum	281	BRUENINGS ear pneumatic	198
DEAN tonsil	23	uterine sound	289	CASPAR lumbar vertebrae	82
DEAVER	19	uterine depressor	289	CASTROVIEJO eye	179
DEBAKEY vascular/thorax	24	uterine dilator	285	CLARK eye	178
bandage eccentric	30	uterus scissors	25	COLLIN vaginal	276
DOYEN gynecological	25	SINGLEY forceps	37	COTTLE nas	213
DUBOIS gynecological	25	sinker, corticalis	145	CRITCHETT eye	178
enterotomy	28	SKENE tenaculum forceps	286	CUSCO laser	277
enucleation	22	skin straightening plate	15	CUSCO, vaginal	276,277
ESMARCH bandage	30	slotted hammer	143	CZERNY rectal	272
FOMON nasal	22	SLUDER BALLENGER		DOYEN vaginal	281
GILLIES with needleholder	95	tonsillectome	238	GOLDSTEIN eye	179
GOOD tonsil	23	small fragment plate	163	GRAEFE eye	178
gum	29	screws cancellous	152,153,155	GRAVE vaginal	276
HEATH ligature	28	SMELLIE obstetrical hook	303	GRAVE laser model, vaginal	276
HEYMANN nasal	22	perforator	305	GRUBER ear	198
incision	19	SMILLIE meniscotomes	131	HARMTANN ear	198
iris	21	SMITH BUIE rectal spreader	273	HARTMANN HALLE nasal	212
JOSEPH	21	eye speculum	178	JACKSON	281
KELLY fistula	25	FERRIS forceps, tissue	36	KALLMORGEN vaginal	280
KILNER	21	FERRIS forceps laminectomy	173	KILLIAN septum	213
KLINKENBERGH LOTH thorax	27	HEYWOOD pile forceps	275	KOGAN endo	282
LEXER baby	20	PETERSEN chisels	122	KRISTELLER vaginal	278-280
LEXER	20	PETERSEN gouges	122	LANCASTER eye	179
LISTER bandage	30	PETERSEN nail	149	LANDAU	282
LITTAUER ligature	28	PETERSEN plate	149	LISTER BURCH eye	178
LORENZ bandage	30	POTTS forceps	34	MATHIEU rectal	272
MAYO (HARRINGTON)	19	POTTS vascular scissors	24	MELLINGER AXENFELD eye	178
MAYO	19	US Army gauze scissors	29	MELLINGER eye	178
MAYO NOBLE	19	SMITHWICK clip applying forceps	166	MUELLER eye	179
MAYO STILLE	19	nerve hook	168	MURDOCK eye	178
McGUIRE corneal	32	snare, BRUENINGS tonsil	237	PARK eye	179
McINDOE cartilage	27	EVES tonsil	237	PEDERSON vaginal	276
METZENBAUM	20,21	KRAUSE nasal	219	PRATT rectal	272
trocar universal abdominal	90	TYDING tonsil	238	SEMM vaginal	277
universal diagnostic	3	WESTON rectal polypus	275	SIEGLE ear pneumatic	198
vBUREN dilators	271	WILDE nasal	219	SIMS vaginal	281
SEXTON ear knife	202	SNELLEN entropium forceps	195	SIMS rectal	272
SHEA scissors micro	205	lens scoop	184	SMITH eye	178
shears, BETHUNE rib	249	solution bowl	309	STEVENSON eye	179
BRUNNER rib	249	SOMER uterine elevating forceps	288	THUDICHUM nasal	212
CORYLLOS rib	249	sound, COLLIN uterine	289	TIECK HALLE nasal	213
GIERTZ STILLE rib	249	MARTIN uterine	289	TOYNBEE ear	198
GLUCK rib	248	SIMS uterine	289	TRELAT vaginal	277
rib	248,249	spare blade for dermatome	15	Vienna Mod. nasal	212
SAUERBRUCH FREY rib	249	spare lamp cold light handle, laryngoscope	9	VOLTOLINI nasal	212
SAUERBRUCH rib	249	spare lamp laryngoscope	9	WEEK eye	178
STILLE plaster cast	106	spatula, ALLISON lung	253	WILLIAMS eye	178
STILLE rib	248	BANGERTER cyclodialysis	184,185	YANKAUER postnasal	214
SHERMAN bone plate	164	CULLER iris	184	ZIEGLER eye	179
screw	164	CUSHING brain	171	SPENCER ligature scissors	28
STILLE bone drill	134	ELSCHNIG cyclodialysis	184	WELLS hemostatic forceps	46
SIEBOLD gynaecological scissors	25	OLIVECRONA brain	171	spherical burr	134
SIEGLE ear speculum pneumatic	198	plaster	89	splinter forceps	38
SILVER chisel plastics	224	WECKER iris	184	SPRATT bone curettes	119
silver clips stomach suturing	266	WHEELER cyclodialysis	185	spreader, BEESON plaster	108
SIMCOE suturing cannula	196	specula, GRUBER ear	198	BOSE tracheal	245
SIMON abdominal retractor	74	speculum, ALAN PARKS rectal	273	CASPAR laminectomy	81
bone curette	120	ARRUGA eye	178	CASPAR soft tissue	80,81
uterus scoop sharp	297	AUVARD vaginal	282	CASTANEDA ALU, thorax	252
SIMPSON BRAUN		BARR rectal	272	CLOWARD cervical spine	79
obstetrical forceps	300	BARRAQUER Colibri eye	178	CLOWARD lamina	171
LUIKART obstetrical forceps	301			DARLING	79

	Page		Page		Page
FINOCHIETTO, rib	250	suture clip set in metal case	105	TOOK corneal knife	181
FINOCHIETTO BURFORD, rib	251	suturing set in metal box	105	TOTI drill	137
FRAZIER	83	SWEET clip applying forceps	166	tourniquet „clip“	2
HAGLUND STILLE plaster	108	syringe, MENGHINI aspiration	91	towel clamps	59
HAIGHT rib	252	REINER ear	201	TOWNSEND KEVORKIAN	
HENNIG plaster	108	tonsil	238	punch biopsy	294
INGE vertebrae	171	TABB sickle knife	210	mini punch	295
MERCEDES thorax	253	tap for cannulated screws	145	mini punch rotating	294
MILLIN bladder neck	269	tape measure	7	mini tip	294
MOLLISON	79	TARNIER cranioclast	305	TISCHLER MORGAN	
SMITH BUIE rectal	273	forceps, obstetrical	302	punch biopsy	294
TUFFIER rib	252	TAYLOR hammer	6	TOYNBEE ear specula	198
spud, DIX foreign body	182	SCHMIEDEN dura scissors	27	tracheostomy set	
DIX and needle	185	spinal retractor	131	tractor, LUIKART BILL	302
SPURLING forceps laminectomy	172	TEALE vulsellum forceps	287	TRAUBE hammer	6
St. MARTIN suture forceps	194	telescopic wire guide	135	tray, instrument	310
STACKE ear probe	88	TERSON capsular forceps	193	sterilization	312
STAUDE MOORE		THOMAS PRICE bronchus clamps	254	TRELAT speculum	277
tenaculum forceps	286	THOMS ALLIS forceps	259	trephine, CASTROVIEJO	196
StCLAIR THOMSON curette	229	GAYLOR biopsy forceps	292	FRANCESCHETTI keratoplastic	196
steel case	308	THOMSON StCLAIR currettes	229	trephines, ELLIOT	197
STEINMANN pin	139	WALKER bladder retractor	268	trocar abdominal	90
sterilization trays sheet metal	312	THOREK lung (thorax) scissors	27	trocar, COAKLEY antrum	90
sterilization trays wire mesh	312	THUDICHUM nasal speculum	212	FLEURANT for bladder	90
sterilizing forceps	105	TIECK HALLE nasal speculum	213	LICHTWITZ antrum	90
STERNBERG lip retractor	230	tightener for wiredrills	140	NELSON thorax	90
stethoscope, BOWLES	5	tightener for PARHAM band	118	OCHSNER thorax	90
Duplex	5	TILLEY ear forceps	204	UCKERMANN, tracheostomy	245
FORD	5	tip, BRUENINGS forceps	240	trocar universal abdominal	90
FORD BOWLES	5	CORDES forceps	240	TROELTSCH nasal	
PINARD	5	FRAENKEL forceps	240	dressing forceps	214
STEVENS iris forceps	187	KEVORKIAN biopsy	296	WILDE ear forceps	203
lens hook	182	KRAUSE forceps	240	TROEMNER hammer	6
needleholder	96	LANGE forceps	240	TROUSSEAU tracheal dilator	245
tenotomy scissors	22	NABATOFF probe only	88	TROUTMAN CHRIS blade breaker	13
STEVENSON eye speculum	179	ROSENBERG forceps	240	Colibri iris forceps	189
STIEGLITZ splinter forceps	38	SCHEINMANN forceps	240	rectus forceps	191
STILLE bone chisel	121	SCHUMACHER forceps	240	tube, ADSON aspirating	171
bone hand drill	134	SEIFFERT forceps	240	BRUENINGS extension,	
forceps, thumb and tissue	34	TISCHLER KEVOPRKIAN	294	laryngeal	240
GIERTZ rib shears	249	TISCHLER MORGAN	294,296	JACKSON tracheostomy	246
gouge	121	TOWNSEND mini	294	LUER tracheostomy	246
HAGLUND plaster spreader	108	TISCHLER KEVOPRKIAN tip	294	POOLE aspiration	8
HORSLEY bone cutting forceps	114	KEVORKIAN punch	295	WAGENER MOSHER	246
LISTON bone cutting forceps	113	MORGAN biopsy		YANKAUER aspiration	8
LUER rongeur	111	specimen forceps	293	tubing clamps	58
MAYO scissors	19	MORGAN tip	294,296	Tübingen TITAN iris forceps	191
osteotome	121	TOWNSEND MORGAN punch	294	Tübingen air cannula	196
pedicle clamp	55	tissue forceps	34	Tübingen iris forceps	191
plaster cast shears	106	tissue protector f.		Tübingen tying forceps	194
rib shears	248	cannulated screws	145	TUFFIER hemostatic forceps	47
RUSKIN bone rongeur	112	TIVNEN tonsil seizing forceps	237	rib spreader	252
SHERMAN bone drill	134	TOBOLD laryngeal		tuning forks	199,200
STOCKMANN penile clamp	270	cotton applicator	89	TURNBULL nail nipper	307
STONE closing forceps	263	tongue depressor	230	TURREL rectal biopsy forceps	275
WATT intestinal forceps	263	TOENNIS ADSON		twist drill (drill bit)	134,137
WATT locking ferrule	263	neurosurgical scissors	26	TYDING tonsil snare	238
strabismus scissors	22	dura dissector	169	tonsil seizing forceps	237
STRATTE needleholder	94	hemostatic forceps	50	UCKERMANN cotton applicator	89
STRAUSS penile clamp	270	needleholder	94	trocar, tracheostomy	245
rectoscope	273	OLIVECRONA clip forceps	166	ULRICH swab forceps	60
stripper, BUNNELL tendon	132	tongs, CRUTCHFIELD traction	167	umbilical cord scissors	26
vein	89	tongue depressor, wood	230	universal wire scissors	29
STRUEMPPEL ear forceps	204	tonsil injection needles	238	universal seizing forceps	105
STRULLY neurosurgical scissors	26	tonsil loops	237	universal bandage scissors	30
STRUYCKEN nasal forceps	217	tonsil syringe	238	universal diagnostic set	3
suture needles	102,103	tonsillectome, SLUDER BALLENGER	238	universal wire scissors	29

	Page		Page
UNNA comedo extractor	306	WIGMORE plaster saw	106
urethrotome, MAISONNEUVE	269	WILDE nasal snare bayonet	219
US Army retractor double pair	65	snare ear polypus	203
SMITH Army gauze scissors	29	TROELTSCH ear forceps	203
VAN BUREN sequestrum forceps	117	WILDER lachrymal dilator	186
van DOREN biopsy forceps	292	lens scoops	184
VANNAS iridectomy scissors	33	WILLET MARTEL scalp flap forceps	47
Varifocal ophthalmoscope	2	WILLIAMS eye speculum	178
vascular/coronary scissors	23	grasping forceps	260
vBUREN dilating bougie	271	screw driver/holder	144
vBUREN dilation set	271	WILLIGER double curette	120
vein stripper	89	hammer	125
VERBRUGGE		periosteal	126
bone holding forceps	116	WINTER placenta	
VERRES pneumoperitoneum		and ovum forceps	304
needle	91	wire, bone	141
Vienna Model nasal specula	212	wire cutters	142
VIRCHOW cartilage knife	16	wire cutting and bending forceps	141
skull breaker	124	loop electrode	315
VIRTUS (RALK) splinter forceps	38	wire guide telescopic	135
VOLKMANN bone curettes	119,120	LOUTE tightener/twister	141
retractors	69,70	wiredrill, KIRSCHNER	139
VOLTOLINI nasal speculum	212	WITTNER biopsy forceps	293
vPETZ suturing apparatus	266	WOLFF plaster cast breaker	108
WACHENFELDT clip applying		WOOD CRILE needleholder	92
forceps	104	wrench for extension bows	140
clips	104	wrench, LANE bone plate	144
WADSWORTH TODD cautery	184	wrenches, pair of,	
WAGENER hooklet, ear,	203	for plaster cutter	107
MOSHER tube	246	WRIGLEY obstetrical forceps	300
WAGNER forceps laminectomy	173	WULLSTEIN HARTMANN	
scissors	29	ear forceps	204
WALLICH abortion scoop	304	scissors micro mini	207
WALSHAM septum		sickle knife	210
straightening forceps	228	WEITLANER retractors	76
WALTON comedo extractor	306	WYLIE uterine dilator	285
foreign body gouges	182	YANKAUER aspiration tube	8
WANGENSTEEN forceps	37	postnasal speculum	214
needleholders	93	YASARGIL clips	176
WARTENBERG pin-wheel	7	miniclips	177
washers for bone screws	152,153,155	YEOMAN rectum biopsy forceps	275
watchmaker's forceps	38	YOUNG boomerang needle holder	99
WATSON CHEYNE elevator	129	prostatic forceps	267
WEBER lens scoop	184	prostatic retractor	267
WECKER iris scissors	32	spare needle	99
iris spatula	184	tongue holding forceps	231
WEEK eye speculum	178	ZAUFAL JANSEN rongeur	111
WEIL BLAKESLEY forceps	216	ZENKER dissecting/ligature	
WEITLANER retractors	76	forceps	51
WULLSTEIN retractors	76	ZIEGLER capsulotomy knife	181
WELLS enucleation scoop	184	eye speculum	179
SPENCER hemostatic forceps	46	head mirror	4
WERTHEIM CULLEN		iris knife	180
hysterectomy forceps	57	lachrymal dilators	186
hysterectomy forceps	57	mirror	4
preparation scissors	25		
WEST chisel nasal	224		
gouge nasal	224		
WESTCOTT iridectomy scissors	39		
tendon scissors	32		
WESTON rectal polypus snare	275		
WHEELER cyclodialysis spatula	185		
discission knife	180		
WHITE tonsil seizing forceps	236		
WHITEHEAD mouth gag	232		
WIEDER tongue depressor	230		
iris hook	182		

## Table des matières

Groupe		Page
102	Diagnostic	1- 7
104	Anesthésie	8- 9
106	Bistouris, Couteaux	10- 16
108, 109	Ciseaux	18- 33
110, 111	Pincés à dissection	34- 40
112	Pincés hémostatiques	42- 57
112	Pincés serre-tube	58
114	Pincés à champs	59
116	Pincés à pansements et à polypes	60- 63
118	Ecarteurs	64- 87
120	Stylets, Sondes, Porte-coton	88- 89
122	Trocarts, Aiguilles à ponction	90- 91
124, 126	Suture	92- 104
128	Instruments pour stérilisation	105
130	Bandages plâtrés	106- 108
132 -136	Chirurgie osseuse, Ostéosynthèse	109- 166
140	Neurochirurgie, Laminectomie	167- 177
142	Ophthalmologie	178- 197
144	Otologie	198- 211
146	Rhinologie	212- 229
148	Bouche et langue	230- 234
150	Amygdales	235- 238
152	Larynx	239- 241
153	Pincés flexibles endoscopiques	242- 244
154	Trachéotomie	245- 246
154	Goitre	247
156	Thorax	248- 255
162	Vesicule biliaire	256- 257
164	Rein	258
164	Intestin, Estomac	259- 266
166	Urologie	267- 271
168	Rectum	272- 275
170	Gynécologie	276- 299
172	Obstétrique	300- 305
174	Dermatologie, Hygiène	306- 307
188	Boîtes et plateaux à instruments	308- 312
190	Chirurgie à haute fréquence	314- 319



	Page		Page		Page
abaisse-langue, ANDREW	230	alésoir p. clous		BAKES sondes biliaires	257
abaisse-langue bois	230	centromédullaires	142	BALFOUR écarteurs abdominaux	84
BRUENINGS	230	ALEXANDER ciseau	121	BALLENGER couteau mobile	221
DAVIS BOYLE	232	gouge	121	élévateur p. cloison	222
FRENZEL	230	MATSON rugine	128	HAJEK élévateur cloison	222
HARTMANN	230	pince à biopsie	292	pince à préhension	
KILNER DOUGHTY	233	rugine raspatoire	126	amygdalienne	237
McIVOR	233	ALLIS ADAIR pince	259	SLUDER amygdalotome	238
TOBOLD	230	baby pince	259	bandages, BERGMANN ciseaux à	30
WIEDER	230	JUDD pince	259	ciseaux à, universels	30
ADLERKREUTZ pince	36	pince intestinale	259	LISTER ciseaux à	30
ADSON baby écarteur	77	THOMS pince	259	bandes frontales	4
baby pince hémostatique	48	ALLISON spatule pulmonaire	253	BANGERTER spatule à	
BROWN pince	35	ALM écarteurs	76	cyclodialyse	184
écarteur	77	ALVIS curette à corps étrangers	182	BARANY assourdisseur	200
écarteur à duremère	168	amniotome, BEACHAM	289	BARBARA aiguilles	210
élévateur	128	ampoules de rechange	4,9	crochet	210
micro pince	35	amputation, CHARRIERE scie à	133	picks	210
pince	35	couteaux à	15	BARKAN couteau à goniotomie	181
pince à hypophyse	170	ANDREW abaisse-langue	230	BARNHILL couteau à végétations	229
pince gouge	110	angiotribe, FERGUSSON	46	BARR spéculum rectal	272
pince hémostatique	48	anse, BILLEAU auriculaire	203	BARRAQUER Colibri blépharostat	178
pince à dissection	35	avec aimant oculaire	197	Colibri pince à iris	189
porte-aiguille	94	électrodes a haute		Colibri ciseaux à iris	32
rongeur	110	fréquence	314,315	couteau p. kératoplastie	181
TOENNIS ciseaux	26	SNELLEN	184	KATZIN pince à iris	189
tube d'aspiration	171	WEBER	184	pince à épilation	197
AEBLI ciseaux cornéens	22	WILDER	184	pince à fixation	192
agrafes, boîte à suture	105	anses	203,219	pince chambre antérieure	191
agrafes en argent p.		anses amygdaliennes	237	porte-aiguille	97
suture intestinale	266	anuscope, HIRSCHMANN	274	BARRETT pince utérine	286
MICHEL	104	IVES FANSLER	274	BARTON forceps	301
WACHENFELDT	104	appareil compressif complet	132	tracteur	301
aiguille à injections		ARCHER pince a échardes	38	BAUMGARTNER porte-aiguille	92
amygdaliennes	238	Arkansas pierre a repasser	16	BEACHAM amniotome	289
aiguille à ponction lombaire	91	ARRUGA blépharostat	178	BECKER cystotome	182
aiguille à cataracte	181	crochets	182	BECKMANN couteau	
aiguille, BARBARA	210	GILL pince capsulaire	192	à végétations	229
BOWMANN dissection	181	KALT porte-aiguille	97	EATON écarteur	78
COOPER	98	pince capsulaire	193	écarteur	78
DAVIS pour corps étrangers	181	porte-aiguille	96	BEEBEE ciseaux	29
DESCHAMPS à ligatures	98	protecteur	184	BEER pince à épiler les cils	197
DIX et ciseau-burin	185	ASCH pince à redresser la cloison	228	BEESON écarteur à plâtre	108
DUPUY WEISS amygdalienne	236	aspirateur, DASTOOR capsulaire	185	BELLUCCI ciseaux micro	205
FRANCIS pour corps étrangers	181	aspiration, ADSON tube à	171	BENGOLEA pince hémostatique	48
FRANKLIN SILVERMANN	91	BUIE tube à	275	BENNETT levier à os	129
aiguille intestinale	103	POOLE tube à	8	BERENS kérateome	180
KEITH à sutures	103	YANKAUER tube à	8	BERGMANN ciseaux à bandages	30
KOENIG à sutures	103	assourdisseur, BARANY	200	scie à plâtres	106
KRONECKER à ligature	98	AUFRIEHT écarteur nasal	227	BERKE pince musculaire	191
LEVINSON pour corps		râpe nasale	224	BERLINER marteau à percussion	6
étrangers	181	autopsie, jeu d'instruments à	124	BERNHARD pince à champs	59
LICHTWITZ sinus maxillaire	219	AUVARD spéculums vaginaux	282	BERTILLON céphalometre	7
MENGHINI biopsie du foie	91	AXENFELD curette à chalazion	183	BEST pince intestinale	263
NELSON à ligature	98	AYER pinces à chalazion	195	BETHUNE costotome	249
aiguille p. anesthésie du pudendus	91	BABCOCK pinces à intestins		BEUSE ciseaux	23
aiguille p. corps étrangers	181	et tissus	259	BEYER pince emporte-pièce	218
POLITZER à paracentèse	202	BABINSKY marteau	6	pince gouge	111
REVERDIN	99	BACKHAUS pince à champs	59	BILL LUIKART tracteur	302
ROSEN	211	BAGGISH pince à biopsie	295	BILLEAU anse auriculaire	203
aiguilles à suture	102,103	BAILEY baby rapprocheur		bipol pince à coagulation	316-318
VERRES à pneumopéritoine	91	des côtes	253	BIRCHER GANSKE	
YOUNG de rechange	99	GIBBON rapprocheur des côtes	253	davier porte-os	117
ALAN PARKS spéculum rectal	273	rapprocheurs des côtes	253	méniscotome	131
ALBEE fraises	137	bâillon, MAUNDER en bois	234	BISHOP HARMAN pince à iris	190
alésoir, CRUTCHFIELD	167	PITHA en silicone	234	HARMAN pince à iris	190
KUENTSCHER fémur	143	BAINBRIDGE pince hémostatique	53	bistouri, CARPENTER amygdalien	235

	Page		Page		Page
CARPENTER amygdalien		BOWLES FORD stéthoscope	5	bistouri amygdalien	
et énucléateur	235	stéthoscope	5	et énucléateur	235
CONVERSE à plastique nasale	220	BOWMAN blépharostat	178	CASPAR écarteurs	80-82
COTTLE à plastique nasale	220	couteau à dissection	180	speculum vertébral	82
FREER à muqueuse	220	stylet lacrymal	186	valves	80,82
HALLE à duremère	170	BOWMANN aiguilles à dissection	181	casse-lames, CASTROVIEJO	13
JOSEPH a plastique	220	BOYNTON porte-aiguille	96	TROUTMAN CHRIS	13
JOSEPH nasal	220	BOZEMANN DOUGLAS		CASTAÑEDA ALU écarteur	252
lame stérile	11	pince à pansements	63	CASTROVIEJO blépharostat	179
bistouri manche métal	14	porte-aiguille	93	casse-lames	13
PARKER fin	14	BRAUN cranioclaste	305	ciseaux cornéens	33
bistouri usage unique stérile	12	crochet à décapitation	305	ciseaux à iridectomie	32
bistouris, manches de	10	dépresseur utérin	289	compas marqueur	185
BLAKE curette utérine	297	pince utérine	286	dilatateur lacrymal	186
MAYO pince à calculs biliaires	256	SIMPSON forceps	300	kératome	180
pincés à calculs biliaires	256	STADLER ciseaux à épisiotomie	26	pince a fixation	192
blépharostat, ARRUGA	178	BREISKY spéculum vaginal	282	pince capsulaire	193
BARRAQUER Colibri	178	broche de guidage	143	pince à sutures	194
BOWMAN	178	broche, KIRSCHNER	139	porte-aiguille	97
CASTROVIEJO	179	BROWN ADSON pincés	35	spatule à cyclodialyse	184,185
CLARK	178	BRUENINGS abaisse-langue	230	trépan	196
CRITCHETT	178	couteau p. cloison	221	cautére, WADSWORTH TODD	184
GOLDSTEIN	179	embout pince laryngienne	240	céphalomètre, BERTILLON	7
GRAEFE	178	pince coupante nasale	215	cerclage, fil pour	141
LANCASTER	179	rallonges	240	CHAPUT pince hémostatique	47
LISTER BURCH	178	serre-nœud amygdalien	237	CHARRIERE scie à amputation	133
MELLINGER	178	spéculum auriculaire		chasse-clous, KUENTSCHER	143
MELLINGER AXENFELD	178	pneumatique	198	CHEATLE pince à instruments	105
MUELLER	179	BRUNETTI burin spinal	124	CHERON pince à pansements	62
MURDOCK	178	BRUNNER conducteur bois		CHEVALIER JACKSON pince	241
PARK	179	artificiel	100	CHILDE pince pour bords	
SMITH	178	costotome	249	de la plaie	104
STEVENSON	179	pince intestinale	263	chordotome, FRAZIER	170
WEEK	178	sonde conductrice	100	CINELLI ciseau-burin	223
WILLIAMS	178	BRUNS ciseaux à bandes	30	ciseau, ALEXANDER	121
ZIEGLER	179	curettes tranchantes	120	DIX à corps étrangers	182
BLOHMKE pince à préhension		BRYANT pince à pansement	62	LEBSCHÉ sternal	124
amygdaliennne	237	boîte en verre avec		PASSOW hémostatique	211
BLOUNT écarteur à genou	131	couvercle	308,309	ROLLET à extirpation	182
levier à os	131	BUCHWALD abaisse langue	230	SMITH PETERSEN	122
BLUMENTHAL pince gouge	109	BUCK couteau auriculaire	202	ciseau-burin	121
BODENHAMMER spéculum rectal	272	curettes auriculaires	201	ciseau-burin, CINELLI	223
BOEHLER clou	149	levier corps étrangers	204	COTTLE	223
étrier à extension	140	marteau à percussion	6	FOMON	223
pince coupante à os	113	BUIE SMITH écarteur rectal	273	FREER	222
pince gouge	111	tube d'aspiration	275	HIBBS	123
BOERMA forceps	302	BUMM curettes utérines	299	HOKE	123
BOETTCHER ciseaux à amygdales	23	BUNGE curette p. exentération	183	LEXER	123
boîtes à aiguilles	308	BUNNELL écorcheur de tendons	132	PARTSCH	121
boîte à suture par agrafes	105	perforateur à main	135	SILVER	224
boîte à sutures	105	BUNT 'épingle de sécurité'	105	STILLE	121
boîte acier inoxydable	308	BURCH fourchette à fixation	181	WEST nasal	224
à poche	105	LISTER blépharostat	178	ciseaux à bandages	30
GUYON, jeu de dilatateurs	270	burin, BRUNETTI spinal	124	ciseaux à cordon ombilical	26
de trachéotomie		VIRCHOW p. crâne	124	ciseaux à entérotomie	28
KONRICH à filtre	311	BURKE pince à biopsie	294	ciseaux à énucléation	22
PETRI	310	BUSCH ciseaux à cordon ombilical	26	ciseaux à envies	307
SCHIMMELBUSCH	311	canule, Bonn à irrigation	196	ciseaux à gencives	29
STRAUSS à rectoscopie	273	Hamburg, boutonnée	196	ciseaux à iris	21
BONACCOLTO pince à strabisme	190	JACKSON trachéale	246	ciseaux à ongles	307
Bonn canule à irrigation	196	LUER trachéale	246	ciseaux à parametrium	24
Bonn pince à iris	190,191	SCHEIE ophtalmique	196	ciseaux à plâtre	30
BORCHARDT fraise olivaire	137	Tübingen à air	196	ciseaux à préparation de nerfs	26
BOSE éarteur trachéal	245	CARMALT pince à échardes	38	ciseaux à préparation	26
BOUCHERON spéculum		ROCHESTER pince		ciseaux à strabisme	22
auriculaire	198	hémostatique	46	ciseaux, AEBLI cornéens	22
bougie, GUYON dilatatrice	271	CARPENTER bistouri amygdalien	235		

	Page		Page		Page
BEEBEE .....	29	TOENNIS ADSON		COLVER pince à préhension	
BELLUCCI micro .....	205	neurochirurgicaux .....	26	amygdalienne .....	236
BEUSE .....	23	universels à fil métallique .....	29	compas, COLLIN pelvimètre .....	303
BOETTCHER à amygdales .....	23	VANNAS à iridectomie .....	33	COLLYER pelvimètre .....	303
BRAUN STADLER à épisiotomie .....	26	ciseaux vasculaires/coronaires .....	23	MARTIN pelvimètre .....	303
BRUNS à bandages .....	30	WAGNER .....	29	compresseur, CORWIN	
BUSCH à cordon ombilical .....	26	WERTHEIM à préparation .....	25	amygdalien .....	237
CASTROVIEJO cornéens .....	33	WESTCOTT à tendons .....	32	conducteur, BRUNNER .....	100
CASTROVIEJO à iridectomie .....	32	WESTCOTT iridectomie .....	39	CONNIN AMSLER marqueur .....	185
COTTLE nasaux .....	23	WULLSTEIN microchir.		CONVERSE bistouri	
CRAFOORD pulmonaires .....	27	à otologie .....	207	à plastique nasale .....	220
DANDY neurochirurgicaux .....	27	ciseaux .....	18-33,205,207	COOLEY Atrauma pince .....	40
DEAN à amygdales .....	23	CITELLI pince emporte-pièce .....	218	COOPER aiguille .....	98
DEAVER .....	19	clamp, COLLIN p. cordon		CORDES embout de pince	
DEBAKEY		ombilical .....	303	laryngienne .....	240
vasculaires/thoraciques .....	24	CRAFOORD pince à bronches .....	51	CORWIN compresseur	
à bandages		DEBAKEY Bulldog atrauma .....	41	amygdalien .....	237
excentriques .....	30	DESJARDINS p. conduit biliaire .....	54	CORYLLOS costotome .....	249
DOYEN gynécologiques .....	25	FINOCHIETTO bronchique .....	254	écarteur thoracique .....	75
DUBOIS gynécologiques .....	25	GLOVER cardiovasc. atrauma .....	41	COS pince à fil métallique .....	206
ESMARCH à bandages .....	30	GRAY pour conduit biliaire .....	54	costotome .....	248
FOMON nasaux .....	22	GREEN ARMYTAGE		costotome, BETHUNE .....	249
GILLIES porte-aiguille .....	95	pince utérine .....	303	BRUNNER .....	249
HEATH à ligatures .....	28	KANE p. cordon ombilical .....	303	CORYLLOS .....	249
HEYMANN nasaux .....	22	LAHEY p. conduit biliaire .....	53	GIERTZ STILLE .....	249
JOSEPH .....	21	LANE pince stomacale .....	265	GLUCK .....	248
KELLY à fistules .....	25	LOWER p. conduit biliaire .....	53	SAUERBRUCH .....	249
KILNER .....	21	MIXTER p. conduit biliaire .....	54	SAUERBRUCH FREY .....	249
KLINKENBERGH LOTH		MOYNIHAN .....	54	STILLE .....	248
thoraciques .....	27	PRICE THOMAS .....	254	COTTLE bistouri plastique nasale .....	220
KNOWLES à bandages		SAROT bronchique .....	255	ciseau-burin .....	223
des doigts .....	30	SEMB bronchique .....	255	ciseaux nasaux .....	23
LEXER .....	20	CLAR lampes frontales .....	4	couteau plastique nasale .....	220
LITTAUER à ligatures .....	28	CLARK blépharostat .....	178	écarteur .....	227
LORENZ à bandages .....	30	CLEVELAND pince gouge .....	109	élèveur pour la cloison .....	222
MAYO (HARRINGTON) .....	19	clips, YASARGIL .....	176,177	KAZANJIAN pince	
MAYO .....	19	clou, BOEHLER .....	149	coupante à os .....	113
MAYO NOBLE .....	19	JEWETT .....	150	NEIVERT écarteur double .....	227
MAYO STILLE .....	19	Clou à crochet .....	146	périostotome .....	222
McGUIRE cornéens .....	32	KUENTSCHER .....	147,148	spéculum nasal .....	213
McINDOE à cartilages .....	27	SMITH PETERSEN .....	149	coupe-bague .....	133
METZENBAUM .....	20,21	STEINMANN .....	139	coupe-cors, Credo .....	307
microchirurgicaux .....	33	CLOWARD écarteurs .....	79	coupe-fil, Diamant .....	142
ciseaux micro à otologie .....	207	écarteur vertébral .....	171	pince à double articulation .....	142
micro gynécologiques .....	33	coagulation, électrodes à .....	314,315	coupe-ligature .....	244
NORTHBENT(SPENCER)		pincés bipolaires à .....	316-318	couteau à amputation .....	15
à ligatures .....	28	COAKLEY curette p. sinus .....	228	couteau à cerveau .....	16
POTTS DE MARTEL		trocart sinus maxillaire .....	90	couteau, BALLENGER mobile .....	221
vasculaires .....	23	COLCLOUGH pincés		BARKAN à goniotomie .....	181
POTTS SMITH vasculaires .....	24	emporte-pièce .....	175	BARNHILL à végétations .....	229
ciseaux pour incisions .....	19	COLLIER porte-aiguille .....	92	BARRAQUER	
PRINCE à amygdales .....	23	COLLIN clamp p. cordon ombilical .....	303	p. kératoplastique .....	181
REYNOLDS .....	21	compas pelvimètre .....	303	BECKMANN à végétations .....	229
SANVENERO .....	21	DUVAL pince .....	36	BOWMAN à discission .....	180
SATINSKY thoraciques .....	27	dynamomètres .....	2	BRUENINGS p. cloison .....	221
SCHMIEDEN TAYLOR duremère .....	27	écarteurs abominaux .....	86,87	BUCK auriculaire .....	202
SCHUMACHER à cordon		HARTMANN écarteur .....	65	COTTLE à plastique nasale .....	220
ombilical .....	26	hystéromètre .....	289	DEAN à iridectomie .....	180
SHEA micro à otologie .....	205	manche de bistouri .....	10	DEUTSCHMANN à cataracte .....	179
SIEBOLD gynécologiques .....	25	marteau .....	125	ELSCHNIG cornéen .....	181
SIMS utérins .....	25	pince à pansements .....	62	FREER p. cloison .....	220
SMITH US Army à gaze .....	29	pince hémostatique .....	47	GILL cornéen .....	181
SPENCER à ligatures .....	28	pince hystérolabe .....	288	GRAEFE à cataracte .....	179
STEVENS à ténotomie .....	22	pince pour agrafes .....	104	KNAPP à iridectomie .....	180
STILLE à plâtres .....	106	pince tirelangue .....	231	LANGENBECK à résection .....	15
STRULLY neurochirurgicaux .....	26	spéculum vaginal .....	276	MUCK à périoste .....	211
THOREK pulmonaires .....	27	COLLYER compas pelvimètre .....	303	PAUFIQUE p. kératoplastique .....	181

	Page		Page		Page
PLESTER lobaire	210	COAKLEY p. sinus	228	pince à saisir des seringues	105
ROSEN circulaire	210	DAVIEL à cataracte	183	DAY crochet auriculaire	203
SATO cornéen	181	FAULKNER tranchante	228	DE BAKEY porte-aiguille	93
SCHEIE à goniotomie	181	FOX p. lupus	306	de LEE forceps obstétriques	300
SCHUKNECHT à serpette	210	GRAEFE à cataracte	183	De MARTEL guide-scie	169
SCHUKNECHT circulaire	210	HALLE malléable, tranchante	120	POTTS MARTEL	
SEXTON auriculaire	202	HEBRA à chalazion	183	ciseaux vasculaires	23
StCLAIR THOMSON	229	HOUSE double	211	DEAN ciseaux à amygdales	23
TABB à serpette	210	KEVORKIAN à biopsie utérine	290	couteau à iridectomie	180
TOOK cornéen	181	KNAPP à cataracte	183	DEAVER ciseaux	19
VIRCHOW à cartilages	16	LANG, et dissecteur		écarteurs	67
WHEELER à dissection	180	p.sac lacrymal	184	DEBAKEY Atrauma pince	40
WULLSTEIN à serpette	210	LEMPERT	120	Bulldog clamp atrauma	41
ZIEGLER à capsulotomie	181	MARTINI double	120	ciseaux vasculaires	
ZIEGLER à iridectomie	180	MEYHOEFER à chalazion	183	et thoraciques	24
COXETER sonde prostatique	271	NOVAK à biopsie utérine		décolleur, FISCH	211
CRAFOORD ciseaux pulmonaires	27	par aspiration	290	HURD amygdalien	235
pince clamp bronchique	51	PESTALOZZA à faux germes	304	DEJERINE marteaux	6
cranioclaste, BRAUN	305	PIFFARD pour lupus	306	DeMARTEL WOLFSON pinces	264
TARNIER	305	RANDALL à biopsie utérine		DeMARTEL WOLFSON	
Credo coupe-cors	307	par aspiration	290	porte clamps	264
CRILE écarteur double	65	RECAMIER utérine	299	DENHART ouvre-bouche	231
MURRAY porte-aiguille	92	SCHEDE	119	dépresseur, BRAUN utérin	289
pince hémostatique	45	SIMON	120	REICHERT épiglottis	239
porte-aiguille	94	SIMS utérine	299	SIMS utérin	289
RANKIN pince hémostatique	45	SPRATT	119	DERF porte-aiguille	92
TITAN pince hémostatique	45	VOLKMANN tranchante	119,120	dermatome, SCHINK	15
WOOD porte-aiguille	92	WILLIGER double	120	DESCHAMPS aiguilles à ligatures	98
CRITCHETT blépharostat	178	CUSCO spéculums vaginaux	276,277	DESJARDINS clamp p. conduit	
crochet ARRUGA	182	CUSHING écarteur	69	biliaire	54
BARBARA	210	écarteur à nerfs	168	cuiller calc. bil. élastique	257
BRAUN, à décapitation	305	perforateur plat	134	pince à calculs biliaires	256
CASPAR	81	pince à dissection	35	sonde à calculs biliaires	257
DAY auriculaire	203	pince à laminectomie	172	DESMARRES écarteur (paupière)	69
EMMET à fistule	296	spatule cérébrale	171	pince à chalazion	195
GILLIES	227	cuvette ronde	309	DEUTSCHMANN	
GRAEFE TITAN à strabisme	182	CUZZI cuiller pour faux germes	304	couteau à cataracte	179
GRAEFE à iris	68	cystotome GRAEFE	182	DeVILBISS pince crâniale	169
GREEN musculaire	182	CZERNY spéculum rectal	272	DEWEY forceps obstétrique	302
GROSS et curette	202	DANDY ciseaux neurochirurgicaux	27	diagnostic, sets à	3
GUTHRIE	68	écarteur à nerfs	168	Diamant pince coupe-fil	142
JOSEPH à muqueuse	68	pince hémostatique	46	diapason	199
KILNER à peau	306	DARLING écarteur	79	HARTMANN	199
McGEE	211	DARTIGUES pince hystérolabe	288	LUCAE	200
SMELLIE obstétrique	303	DASTOOR aspirateur capsulaire	185	diapason neurologique	200
STEVENS p. lentille cristalline	182	pince à strabisme	190	RYDEL SEIFFER	200
tire-clous	143	DAVIDSON écarteur (scapula)	75	DIEFFENBACH serre-fine	42
WAGNER boutoné	203	DAVIEL curette à cataracte	183	DIETER pince coupe-maillet	206
CRUTCHFIELD alésoir	167	davier, BIRCHER GANSKE		DIETHRICH porte-aiguille	96
tracteur crânéen	167	porte-os	117	dilatateur, HANK utérin	285
cuiller, CUZZI à faux germes	304	DINGMANN porte-os	117	HEGAR utérin	284
DESJARDINS à calculs biliaires	257	FARABEUF LAMBOTTE		vBUREN	271
FERGUSSON à calculs biliaires	257	porte-os	115	WILDER lacrymal	186
GUTMANN à sécrétion	270	FARABEUF porte-os	114	ZIEGLER lacrymal	186
HARTMANN pinces auriculaires	204	FERGUSSON porte-os	114	aimant oculaire	
MAYO à calculs biliaires	257	KERN porte-os	115	avec anse	197
MOORE à calculs biliaires	256	LAMBOTTE porte-os	115	boîte à poche standard	105
SIMON utérine tranchante	297	LANE porte-os	115	casse-lames	13
WALLICH à faux germes	304	LANGENBECK porte-os	114	ciseaux à bandages excentriques	30
CULLER spatule pour l'iris	184	LEWIN porte-os	117	coupe-bague	133
curette, ALVIS à corps étrangers	182	LOWMAN à os	118	diapasons	199
AXENFELD à chalazion	183	daviers porte-os	114-118	écarteurs	76
BLAKE utérine, double	297	SEMB porte-os	114	porte-coton	89
BRUNS	119,120	VERBRUGGE porte-os	116	DINGMANN davier porte-os	117
BUCK auriculaire	201	DAVIS aiguille p. corps étrangers	181	disque à limiter la coupe	138
BUMM utérine	299	BOYLE ouvre-bouche	232	dissecteur, DAVIS à duremère	169
BUNGE p. exentération	183	dissecteur à duremère	169	GREEN cornéen	182

	Page		Page		Page
HORSLEY à duremère	170	FARABEUF double paire	64	TAYLOR spinal	131
MILLIGAN à duremère	169	FINOCHIETTO, acier et ALU	250	THOMSON WALKER vesical	268
dissecteur p. la durèmère	169	FINOCHIETTO BURFORD,		TUFFIER	252
PATON cornéen	181	acier et ALU	251	US Army double paire	65
PENFIELD	170	FINSEN	76	VOLKMANN	69,70
SACHS à duremère	169	FOMON	227	WEITLANER	76
TOENNIS à duremère	169	FRAZIER	83	WEITLANER WULLSTEIN	76
dissection, pinces à	34	FRIEDMAN à perinéorrhaphie	282	YOUNG prostatique	267
DIX aiguille et ciseau-burin	185	FRITSCH	73	écarteur (trachéal)	68
aiguille et gouge	185	GELPI périnéal	86	échardes, ARCHER pince à	38
ciseau à corps étrangers	182	GERSTER pour daviers	118	CARMALT pince à	38
doigtier, LANGENBECK	234	GOELET double	65	FEILCHENFELD pince à	38
DOUGLAS BOZEMANN		GOSSET abdominal	83	HUNTER pince à	38
pince à pansements	63	GRAHAM à nerfs	168	PEET pince à	38
pince à épiler les cils	197	GREEN	72	pinces à	38
trocart et canule	90	HABERER malléable	66	STIEGLITZ pince à	38
DOYEN baby pince intestinale	260	HAIGHT	252	VIRTUS (RALK) pince à	38
ciseaux gynécologiques	25	HARRINGTON	67	ECHLIN pince gouge	112
écarteur abdominal	74	HEANEY	74	Econom set de diagnostic	3
fraises	137	HOFER piliaire	235	Econom tensiomètre à mercure	1
JANSEN ouvre-bouche	231	INGE vertébral	171	écorcheur, BUNNELL à tendons	132
pince à champs	59	ISRAEL	73	écraseur, PAYR intestinal	266
pinces intestinales	260	JANSEN	76	écrou p. vis corticales	155
pince à polypes utérins	288	JUDD MASSON vesical	268	électrodes à coagulation	
rugine costale	127	KELLY	66,74	par HF	314,315
sonde cannelée	88	KIRSCHNER abdominal	85	élévateur, ADSON	128
spéculum vaginal	281	KNAPP	182	BALLENGER p. la cloison	222
tracteur p. fibromes	296	KOCHER	72,73	COTTLE p. la cloison	222
DUBOIS ciseaux gynécologiques	25	KOERTE	73	FREER p. la cloison	221
DUPLAY pince utérine	286	LAHEY	70	FREER p. la cloison	221
Duplex stéthoscope	5	LANGENBECK	71	HAJEK BALLENGER	
DUPUY WEISS		LEGUEU vesical	269	p. la cloison	222
aiguille amygdalienne	236	écarteur des lèvres et des joues	231	HENKE amygdalien	235
DUVAL COLLIN pince	36	LITTLE	70	KEY	128
pince	36	LOVE racine de nerfs	168	KILLIAN p. la cloison	222
pince pour les tissus et intestins	260	LOVE uvulaire	235	LANGENBECK	128
dynamomètre, COLLIN	2	MATHIEU double paire	65	LEMPERT	211
écarteurs		MERCEDES thoracique	253	McDONALD double	129
..... 64-87,246,251-253,267-269		MEYERDING	70	McKENY p. la cloison	221
écarteur à plâtre,	10	MIDDELDORPF	72	MURPHY LANE double	129
écarteur, ADSON	77	MIKULICZ	74	ROGER p. la cloison	221
ADSON à duremère	168	MILLIN col de vessie	269	WATSON CHEYNE double	129
ALM	76	MOLLISON	79	ELLIOT forceps obstétrique	300
AUFRIEHT nasal	227	écarteur à ressort (tige flexible)	68	tréphine	197
BALFOUR abdominal	84	écarteur musculaire (égrigne)	87	ELLIS gouge à corps étrangers	182
BECKMANN	78	NAGER pour le palais	235	ELSCHNIG couteau coméen	181
BECKMANN EATON	78	O'SULLIVAN O'CONNOR		pince à fixation	192
BLOUNT à genou	131	abdominal	83	pince capsulaire	193
BOSE trachéal	245	OLLIER	72	spatule à cyclodialyse	184
CASPAR	80-82	PARKER double paire	64	embout, KEVORKIAN,	
CASTAÑEDA ALU	252	PLESTER	76	pince à biopsie	296
CLOWARD	79	PRATT cystique	274	embouts pour pinces à biopsie	294
CLOWARD vertébral	171	REVERDIN abdominal	66	TISCHLER KEVORKIAN	
COLLIN abdominal	86,87	RIBBON	66	à biopsie	294
COLLIN HARTMANN	65	RICHARDSON	66	TISCHLER MORGAN	
CORYLLOS (thoracique)	75	RICHARDSON EASTMAN	66	à biopsie	294,296
COTTLE	227	ROLLET	182	TOWNSEND mini, à biopsie	294
COTTLE NEIVERT double	227	ROUX	64	EMMET crochet à fistules	296
CRILE double	65	SACHS à nerfs	168	ENGEL scie à appareils plâtrés	106
CUSHING	69	SAUERBRUCH	75	entérotomie, ciseaux à	28
CUSHING à nerfs	168	SCHOENBORN à thyroïde	247	énucléation, ciseaux à	22
DANDY à nerfs	168	SENN double	66	EPPENDORFER KEVORKIAN	
DARLING	79	SENN GREEN	69	pince à biopsie	296
DEAVER	67	SIMON abdominal	74	pinces à biopsie	295,296
DESMARRES (et à paupières)	69	SMITH BUIE rectal	273	TISCHLER MORGAN	
DOYEN abdominal	74	SMITHWICK à nerfs	168	pince à biopsie	296
		STERNBERG des lèvres	230	ESMARCH ciseaux à bandages	30



	Page		Page		Page
couteau à plâtre	108	FOREGGER laryngoscopes	8,9	GOSSET écarteur abdominal	83
étrier à extension	140	foret perforé à vis cannelées	145	gouges	121
étrier, BOEHLER à extension	140	fourchette, BURCH à fixation	181	gouge, ADSON pince	110
KIRSCHNER à extension	140	FOX curette p. lupus	306	ALEXANDER	121
EVES serre-nœud amygdalien	237	FRAENKEL embout de pince		BEYER pince	111
évideur, SEGOND de fibromes	296	laryngienne	240	BLUMENTHAL pince	109
extraction, crochet à clous	143	pince à polypes laryngiens	239	BOEHLER pince	111
extracteur, KUENTSCHER à clous	143	fraises	134,137	CLEVELAND pince	109
FARABEUF davier porte-os	114	fraise, ALBEE	137	DIX et aiguille	185
écarteur double paire	64	BORCHARDT	137	ECHLIN pince	112
LAMBOTTE davier porte-os	115	DOYEN	137	ELLIS à corps étrangers	182
rugine	126	McKENZIE	134	FREER	224
FARREL porte-coton	89	fraise plate	137	FRIEDMAN pince	109
FAULKNER curette tranchante	228	fraise pour corticalis	145	FRYKHOLM pince	112
FAURE pince à biopsie utérine	291	TOTI	137	HAJEK forme V	224
pincés à péritoine	56	FRANCESCHETTI trépan		HIBBS	123
FEHLAND pince intestinale	263	à kératomie	196	KILLIAN CLAUS en V	224
FEILCHENFELD pince à échardes	38	FRANCIS aiguille p. corps		LEKSELL (STILLE) pince	112
FERGUSSON angiotribe	46	étrangers	181	LEMPERT pince	110
cuiller à calculs biliaires	257	FRANKE lancette à prise de sang	2	LEXER	123
davier porte-os	114	FRANKLIN SILVERMANN		LUER pince	110
FERRIS SMITH KERRISON		aiguille à ponction	91	MEAD pince	109
pince emporte-pièce	174	FRAZIER chordotome	170	OLIVECRONA pince	110
SMITH pince à dissection	36	crochet à duremère	68	PARTSCH	121
SMITH pince à laminectomie	173	écarteur	83	RUSKIN pince	111
fil p. cerclage malléable	141	tube d'aspiration	171	SAUERBRUCH pince	112
FINOCHIETTO ALU écarteurs	250	tube à ponction	171	SCAGLIETTI pince	112
FINOCHIETTO BURFORD ALU		FREER bistouri à muqueuse	220	SEMB pince	113
écarteurs	251	ciseau-burin	222	SMITH PETERSEN	122
FINOCHIETTO BURFORD		couteau p. la cloison	220	STILLE	121
écarteurs	251	élevateurs pour la cloison	221	STILLE LUER pince	111
FINOCHIETTO écarteurs	250	gouge	224	STILLE RUSKIN pince	112
clamp bronchique	254	FRENZEL abaisse-langue	230	WALTON à corps étrangers	182
porte-aiguille	94	FRIEDMAN écarteur		WEST nasale	224
FINSEN écarteur	76	à péri-neorrhapie	282	ZAUFAL JANSEN pince	111
FISCH décolleur	211	pince gouge	109	GRADLE pince à épiler les cils	197
FISCHER pince à iris	189	FRITSCH écarteur	73	GRAEFE blépharostat	178
FLEURANT trocart p. la vessie	90	FRYKHOLM pince gouge	112	couteau à cataracte	179
FOERSTER pincés à éponges	61	FUCHS pince capsulaire	193	crochets à iris	68
pince à iris	188	GALLAHER râpe à os	226	crochets à strabisme	182
FOMON ciseau-burin	223	GAUSS pince péricraniale	303	curette à cataracte	183
ciseaux nasaux	22	GELLHORN pince à biopsie	292	cystotomes	182
écarteur aux ailes	227	GELPI écarteur péri-neal	86	pince	35
écarteur aux orifices postérieurs	227	Gemini pince		pincés à iris	186,187
râpes nasales	225	à dissection/à ligature	49	pincés à fixation	192
forceps, BARTON, obstétrique	301	gencives, ciseaux à	29	scarificateur	180
BOERMA, obstétrique	302	QUINBY ciseaux à	29	TITAN crochet à strabisme	182
de LEE, obstétrique	300	GERALD pincés à dissection	37	GRAHAM écarteur de nerfs	168
DEWEY, obstétrique	302	GERSTER écarteur pour daviers	118	GRAVE spéculums vaginaux	276
ELLIOT, obstétrique	300	GERZOG marteau	125	GRAY clamp p. conduit biliaire	54
KIELLAND, obstétrique	300	GIERTZ STILLE costotome	249	GREEN ARMYTAGE	
KIELLAND LUIKART,		GIGLI manche p. scie		pince clamp utérine	303
obstétrique	301	en fil métallique	169	crochet musculaire	182
LUIKART, obstétrique	301	GILL ARRUGA pince capsulaire	192	dissecteur cornéen	182
McLEAN, obstétrique	301	couteau cornéen	181	écarteur	72
McLEAN LUIKART, obstétrique	301	HESS pince à iris	188	pince à fixation	192
McLEAN TUCKER, obstétrique	301	pince à iris	188	SENN écarteur	69
NAEGELE, obstétrique	300	GILLIES crochet	227	GREVEN pince à fil métallique	206
PIPER, obstétrique	302	pince à dissection	37	GROSS curette et crochet	202
SIMPSON, obstétrique	300	porte-aiguille avec ciseaux	95	MAIER pince à pansements	60
SIMPSON BRAUN, obstétrique	300	GLOVER clamp cardiovascul.		GRUBER spéculums auriculaires	198
SIMPSON LUIKART,		Atrauma	41	guide p. broches, télescopique	135
obstétrique	301	GLUCK costotome	248	GUTHRIE crochets doubles	68
TARNIER, obstétrique	302	GOELET écarteur double	65	GUTMANN cuiller à sécrétion	270
WRIGLEY, obstétrique	300	GOLDSTEIN blépharostat	179	GUYON bougie dilatatrice	271
FORD BOWLES stéthoscope	5	GOOD ciseaux à amygdales	23	jeu dilateur en boîte complet	270
stéthoscope	5	GOODELL dilateur utérin	285	mandrin p. sondes en caoutchouc	270

	Page		Page		Page
MAYO pince à pédicule	55	HOESEL porte-aiguille	95	jeu de trachéotomie en boîte	246
pince à pédicule rénal	55	HOFER écarteur pilaire	235	JEWETT clou	150
GUYTON LUNDGAARD		HOHMANN leviers à os	129,130	JOBSON HORNE porte-coton	89
sclérotome	181	HOKE ciseau-burin	123	JOHNS HOPKINS	
HABERER écarteur malléable	66	HOLTH pince p.		pince hémostatique	53
HAGLUND STILLE		capsulotomie/iridotomie	185	HOPKINS serre-fine	42
écarteur à plâtre	108	HOPKINS couteau à plâtre	108	JOHNSON porte-aiguille	94
HAIGHT écarteur	252	JOHNS pince		JONES pince à champs	59
HAJEK BALLENGER élévateur		hémostatique/cond.billi	53	JOSEPH (LEWIS) râpe nasale	225
à cloison	222	JOHNS serre-fine	42	bistouri à plastique nasale	220
CLAUS pince sinus maxillaire	218	horloger, pinces	38	bistouri nasal	220
gouge forme V	224	HORSLEY dissecteur à duremère	170	ciseaux	21
KOFER pince emporte-pièce	218	STILLE pince coupante pour os	114	crochet à muqueuse	68
HALLE bistouri à duremère	170	HOUSE curette double	211	lime à os	224
curette malléable	120	HUBER manche universel	240	périostotome	222
HARTMANN spéculum nasal	212	HUDSON perforateur complet	134	scie nasale	227
TIECK spéculum nasal	213	HUNTER pince à échardes	38	JUDD ALLIS pince	259
HALSEY porte-aiguille	92	HURD décolleur amygdalien	235	MASSON écarteur vésical	268
HALSTED mosquito pince	43	hystéromètre, COLLIN	289	JUERS pince à fil métallique	206
TITAN mosquito pince	43	MARTIN gradué	289	JURASZ pince à polypes	
Hamburg canule boutonnée	196	SIMS gradué	289	laryngiens	239
HANK dilateur utérin	285	impacteur et extracteur pour clous	142	KABIERSKE lance-poudre	200,201
haricot	309	impacteur, KUENTSCHER final	143	KALLMORGEN spéculums	
HARRINGTON écarteur	67	INGE écarteur vertébral	171	vaginaux	280
pince à bronches	254	instrument, LAFORCE		KALT ARRUGA porte-aiguille	97
HARTMANN abaisse-langue	230	à corps étrangers	182	pince capsulaire	193
COLLIN écarteur	65	plateau pour	310	porte-aiguille	97
diapasons	199	insufflateur, POLITZER	201	KANE clamp p. cordon ombilical	303
HALLE spéculum nasal	212	IOWA pince utérine	287	KEITH aiguilles à suture	103
HOFFMANN pince auriculaire	204	iris, BARRAQUER, ciseaux colibri	32	KELLY ciseaux gynécologiques	25
pinces auriculaires	204	BISHOP HARMAN pince	190	écarteur	66,74
pince coupante nasale	217	Bonn pince à	191	pince hémostatique	45
pince hémostatique	42	ciseaux à	21	pince à polypes utérins	288
pince à polypes nasaux	214	FISCHER pince à	189	proctoscope	274
sonde auriculaire	202	FOERSTER pince à	188	RANKIN pince hémostatique	45
spéculums auriculaires	198	GRAEFE pince à	186,187	TITAN pince hémostatique	45
WULLSTEIN pince auriculaire	204	NOYES ciseaux à	32	kératome, BERENS	180
HAUGH pince auriculaire	206	O'CONNOR crochet à	182	CASTROVIEJO	180
HEANEY écarteur	74	STEVENS pince à	187	JAEGER	180
pince à hystérectomie	57	Tübingen, pince à	191	KERN davier porte-os	115
porte-aiguille	93	WECKER ciseaux à	32	KERRISON pince emporte-pièce	218
HEATH ciseaux à ligatures	28	WIENER crochet à	182	KEVORKIAN curettes	
RICHTER pince p. agrafes	104	ISRAEL écarteur	73	à biopsie utérine	290
HEBRA curette à chalazion	183	ITARD sonde auriculaire	202	embout p. pince	
HEGAR dilateurs utérins	283,284	ITERSON écarteur trachéal	245	à biopsie utérine	296
MAYO porte-aiguille	92	IVES FANSLER anoscope	274	EPPENDORFER pince	
OLSEN porte-aiguille	95	JACKSON canule trachéale	246	à biopsie utérine	296
HEGENBARTH pince pour agrafes	104	CHEVALIER pince laryngienne	241	Pacific pince à biopsie utérine	294
HEIFETZ spatule		écarteur trachéal	245	pince à biopsie	293
cérébrale malléable	171	pince porte-tampons	239	TISCHLER embout p.pince	
HEISS pinces hémostatiques	48	spéculum vaginal	281	à biopsie utérine	294
HEISTER ouvre-bouche	231	JACOBS pince utérine	287	TISCHLER pince	
HENKE élévateur amygdalien	235	JAEGER kératome	180	à biopsie utérine	295
HENNIG écarteur à plâtre	108	plaque à paupières	179	TOWNSEND à biopsie utérine	294
HERRICK pince à pédicule rénal	56	JAMESON crochet à strabisme	182	KEY élévateur	128
HESS GILL pince à iris	188	pinces à strabisme	189	KEYES set de trépan cutanés	306
pince à iris	188	JAMISON porte-aiguille	93	KIELLAND forceps obstétrique	300
pince capsulaire	193	JANSEN DOYEN ouvre-bouche	231	LUIKART forceps obstétrique	301
HEYMANN ciseaux nasaux	22	écarteurs	76	KILLIAN CLAUS gouge en V	224
KNIGHT pince coupante nasale	215	MIDDLETON pince coupante	219	élévateur pour la cloison	222
pince coupante nasale	215	pince nasale	214	sonde à irrigation	219
HEYWOOD SMITH		ZAUFAL pince gouge	111	spéculum p. la cloison nasale	213
pince à hémorroïdes	275	JARCHO pince utérine	286	KILNER ciseaux	21
HIBBS ciseau-burin	123	JATHO pince		crochet à peau	306
gouge	123	nasopharyngienne coupante	228	DOUGHTY ouvre-bouche	233
ostéotome	123	JENNINGS ouvre-bouche	232	KIRBY ARTHUR pince à iris	189
HIRSCHMANN anoscope	274	jeu d'instruments à autopsie	124	KIRK marteau	125

	Page		Page		Page
KIRSCHNER broches	139	levier p. modeler attelles	144	LORENZ ciseaux à bandages	30
crochets à extension	140	MURPHY élévateur double	129	LORNA pince à champs	59
crochets à extraction	143	pince à dissection	36	LOUTE tendeur serre-fil	141
écarteurs abdominaux	85	pince à champs	59	LOVE écarteur de racines de nerfs	168
étrier à extension	140	pince à saisir les attelles	144	écarteur uvulaire	235
perforateur à main	135	pince à saisir les vis	144	GRUENWALD pince	
sonde conductrice	100	pince clamp stomacale	265	à laminectomie	172
KLINKENBERGH LOTH		tournevis	144	LOVELACE hémostatique	46
ciseaux thoraciques	27	LANG curette et		pince pulmonaire	254
KNAPP couteau à iridectomie	180	dissect.p.sac lacrymal	184	LOWER clamp p. conduit biliaire	53
curette à cataracte	183	LANGE embout de pince		LOWMAN davier à os	118
écarteur	182	laryngienne	240	LUBET BARBON pince	
LUER pince à		LANGENBECK couteau à résection	15	à polypes nasaux	215
granulations du trachome	195	davier porte-os	114	LUC pince coupante nasale	216
KNIGHT HEYMANN		doigtier	234	LUCAE diapason	200
pince coupante nasale	215	écarteur	71	marteau	125
KNOWLES ciseaux à		élévateur	128	pince auriculaire	203
bandades des doigts	30	rugine raspatoire	126	LUER canule trachéale	246
KOCHER écarteur	72,73	scie à doigt	133	KNAPP pince	
pince hémostatique	45	laryngoscope, FOREGGER	8,9	à granulations du trachome	195
pincés intestinales	261	McINTOSH	8,9	pince gouge	110
sonde à goitre	247	LAWRENCE pince hémost./		STILLE pince gouge	111
spatule vésicale	268	à dissect./à ligatures	52	LUIKART BILL tracteur	302
KOENIG aiguille à suture	103	LEBSCHÉ ciseau sternal	124	forceps obstétrique	301
ROSER ouvre-bouche	231	LEGUEU écarteur vésical	269	KIELLAND forceps obstétrique	301
sonde conductrice	100	spatule vésicale	268	McLEAN forceps obstétrique	301
KOERTE écarteurs	73	LEKSELL (STILLE) pince gouge	112	SIMPSON forceps obstétrique	301
KOGAN endospéculum	282	LEMPERT curette	120	LUNDSGAARD GUYTON	
KONRICH boîte filtre	311	élévateur	211	sclérotome	181
KRAUSE embout de pince		pince gouge	110	sclérotome	181
laryngienne	240	LERCHE pince à dissection	36	LUNIATSCHEK obturateur à gaze	235
serre-nœud	203,219	LERICHE pince hémostatique	48	LURZ pince urétérale	258
KRISTELLER spéculums		LESTER pince à fixation	192	MAGILL pince à introd. sondes	8
vaginaux	278-280	levier à os	130	mains en plomb	118
KRONECKER aiguille à ligature	98	levier, BENNETT à os	129	MAISONNEUVE uréthrotome	
KUENTSCHER alésoir		BLOUNT à os	131	compl	269
pour le fémur	143	BUCK à corps étrangers	204	MALTZ (COTTLE) râpe nasale	225
chasse-clous	143	HOHMANN à os	129,130	manche a piles p. laryngoscopes	9
clou	147,148	LANE p. modeler attelles	144	manches de bistouris	
extracteur de clous	143	QUIRE pour corps étrangers	204	interchangeables	10
impacteur final	143	SELLHEIM p. abaissement		HUBER universel	240
perforateur	143	de la tête	305	manche pour miroirs laryngiens	241
KUHNT rugine cornéenne	181	LEVINSON aiguille		mandrin, GUYON p. sondes,	
LABORDE dilatateur trachéal	245	p. corps étrangers	181	en caoutchouc	270
LAFORCE adénotome	229	LEWIN davier porte-os	117	mandrin Jacobs	136
instrument à corps étrangers	182	LEXER ciseaux	20	marqueur, CASTROVIEJO	
lame de rechange p. adénotome	229	ciseau-burin	123	compas	185
LAHEY clamp p. conduit biliaire	53	gouge	123	CONNIN AMSLER	185
écarteur	70	LICHTWITZ aiguille pour		MARSCHIK pince à amygdales	237
pince à saisir le goitre	247	sinus maxillaire	219	marteaux chirurgicaux	125
pince bronchique	254	trocart pour sinus maxillaire	90	marteau à fente	143
LAMBERT LOWMAN davier à os	118	lien, PARHAM métallique	118	marteau, BABINSKY	6
pince à chalazion	195	lime à ongles	307	BERLINER	6
LAMBOTTE davier porte-os	115	lime, JOSEPH à os	224	BUCK	6
FARABEUF davier porte-os	115	LISTER (sinus) pince à pansement	62	COLLIN	125
ostéotomes	122	BURCH blépharostat	178	DÉJÉRINE	6
rugine	126	ciseaux à bandages	30	marteau fourré de plomb	125
lame de bistouri stérile	11	LISTON couteau à amputation	15	GERZOG	125
lames à rasoir	13	pince coupante à os	113	KIRK	125
lampes frontales CLAR	4	RUSKIN pince coupante à os	113	LUCAE	125
de rechange pour lampe CLAR	4	STILLE pince coupante à os	113	marteau manche à crochet	125
LANCASTER blépharostat		LITTAUER ciseaux à ligatures	28	marteau matière artificielle	125
lance-poudre, KABIERSKE	200,201	pince à épiler	197	MEAD à plaques	
lancettes, électrodes à coagulation	315	pince auriculaire	204	interchangeables	125
FRANKE à prise de sang	2	pince à polypes nasaux	215	QUISLING intranasal	125
LANDAU spéculum vaginal	282	LITTLE écarteur	70	TAYLOR	6
LANE davier porte-os	115	LLOYD impacteur/extracteur	144	TRAUBE	6

	Page		Page		Page
TROEMNER .....	6	NEFF .....	131	NORTHBENT(SPENCER)	
WILLIGER .....	125	SMILLIE .....	131	ciseaux à ligature .....	28
MARTEL De,guide-scie .....	169	MERCEDES écarteur thoracique ..	253	NOTO pince à polypes utérins .....	288
pince p. le cuir chevelu .....	47	mesure graduée .....	310	NOVAK curette aspirante	
WILLET pince p.le cuir chevelu ..	47	METZENBAUM ciseaux .....	20,21	à biopsie .....	290
MARTIN compas pelvimètre .....	303	fino ciseaux .....	20	NOYES ciseaux à iris .....	32
hysteromètres .....	289	porte-aiguille .....	94	pince à polypes nasaux .....	215
pince à cartilages .....	117	MEYERDING écarteur .....	70	O'CONNOR crochet à iris .....	182
St.,pince à suture .....	194	MEYHOEFER curette à chalazion ..	183	O'SULLIVAN O'CONNOR	
MARTINI curette double .....	120	MICHEL agrafes .....	104	écarteur abdominal .....	83
MASSON JUDD écarteur vésical ..	268	miroir postrhinoscopique .....	214	obturateur, LUNIATSCHEK	
porte-aiguille .....	93	pince à poser agrafes .....	104	de gaze .....	235
MASTIN pince musculaire .....	247	pince combinée pour agrafes ...	104	OCHSNER ROCHESTER	
MATHIEU écarteur double paire ...	65	micro ciseaux .....	33	pince hémostatique .....	45
pince à corps étrangers .....	269	micro pince .....	39	sonde à calculs biliaires .....	256
porte-aiguille .....	95	MIDDELDORPF écarteur .....	72	trocart thoracique .....	90
spéculum rectal .....	272	MIDDLETON JANSEN		OLDBERG pince à laminectomie ..	173
MATSON ALEXANDER rugine .....	128	pince coupante .....	219	olive auriculaire .....	201
rugine à périoste .....	128	MIKULICZ écarteur .....	74	olive nasale .....	201
MAUNDER bâillon en bois .....	234	pince à péritoine .....	56	OLIVECRONA pince gouge .....	110
MAY ophtalmoscope .....	2	MILLIGAN dissecteur à duremère ..	169	scie en fil métallique .....	169
MAYO 'épingle de sécurité' .....	105	MILLIN écarteur col de vessie ...	269	spatule cérébrale .....	171
(HARRINGTON) ciseaux .....	19	pince à capsule prastatique ....	267	TOENNIS pince à poser les clips .	166
BLAKE pince à calculs biliaires ..	256	pince p. saisir lambeaux		OLLIER écarteur .....	72
ciseaux .....	19	prostatiques .....	267	OLSEN HEGAR porte-aiguille .....	95
cuiller à calculs biliaires .....	257	pince porte-fil prostatique ....	267	ophtalmoscope .....	2
GUYON pince à pédicule rénal ...	55	miniclip, YASARGIL .....	176,177	ostéotomes .....	121-123
HEGAR porte-aiguille .....	92	miroirs laryngiens .....	241	ostéotome, LAMBOTTE .....	122
NOBLE ciseaux .....	19	miroir, MICHEL,		otoscopie, set pour .....	3
ROBSON pince intestinale .....	262	postrhinoscopique .....	214	ouvre-bouche, DAVIS BOYLE ....	232
sonde à calculs rénaux .....	258	ZIEGLER frontal .....	4	DENHART .....	231
STILLE ciseaux .....	19	MIXTER baby pince hémostatique ..	52	DOYEN JANSEN .....	231
MAYO(HARRINGTON)ciseaux .....	19	clamp pour le conduit biliaire ...	54	HEISTER .....	231
McCULLOUGH		O'SHAUGNESSY pince		JENNINGS .....	232
pincés à strabisme .....	189	hémostatique .....	53	McIVOR .....	233
McDONALD élévateur double .....	129	pince à calculs biliaires .....	256	ROSER KOENIG .....	231
McGEE crochets .....	211	pince hémostatique/bronch./		WHITEHEAD .....	232
McGEE pince à fil métallique .....	206	à ligature .....	52,53	OVERHOLT GEISSENDOERFER ...	49
McGUIRE ciseaux cornéens .....	32	MOELTGEN goniomètre .....	7	rugines à périoste .....	128
McINDOE ciseaux à cartilages .....	27	MOLLISON écarteur .....	79	PARHAM lien métallique .....	118
McINDOE pince striée .....	36	MOORE cuiller à calculs biliaires ..	256	serre-liens .....	118
McINTOSH laryngoscopes .....	8,9	perforateur à main .....	134	PARK blépharostat .....	179
McIVOR ouvre-bouche .....	233	STAUDE pince utérine .....	286	PARKER bistouri fin .....	14
McKENTY élévateur p. cloison .....	221	MOORFIELD pince à suture .....	194	écarteur double paire .....	64
McKENZIE fraise .....	134	moteur à main électrique .....	136	PARTSCH ciseau-burin .....	121
McKENZIE pince à poser clips .....	166	MOYNIHAN pince à champs .....	59	gouge .....	121
McLAUGHLIN plaque .....	149	pince clamp .....	54	PASSOW ciseau hémostatique ...	211
McLEAN forceps obstétrique .....	301	sonde à calculs biliaires .....	257	PATON dissecteur cornéen .....	181
McLEAN LUIKART forceps		MUCK couteau à périoste .....	211	PAUFIQUE couteau	
obstétrique .....	301	MUELLER blépharostat .....	179	p. kératoplastique .....	181
McLEAN TUCKER forceps		MURDOCK blépharostat .....	178	pincés à ligatures .....	194
obstétrique .....	301	MURPHY LANE élévateur double ..	129	PAYR écraseurs intestinaux .....	266
McLEAN TUCKER LUIKART		MUSEUX pince utérine .....	287	SCHMIEDEN	
forceps obstétrique .....	301	MYLES pince coupante nasale ...	217	sonde conductrice .....	100
McPHERSON pince à ligature .....	194	myrte, stylet en feuille de .....	88	sonde conductrice .....	100
MEAD marteau .....	125	NABATOFF trousse à varices .....	88	PEAN pince hémostatique .....	45,47
pince gouge .....	109	NAEGELE forceps obstétrique ...	300	ROCHESTER pince	
mèches .....	134,137	NAGER écarteur		hémostatique .....	45
MEEKER pince hémost./diss./		pour le palais .....	235	PEDERSON spéculum vaginal ....	276
à ligature .....	52	NEFF méniscotome .....	131	PEET pince à échardes .....	38
MELLINGER AXENFELD		NEGUS pince amygdalienne .....	236	PELKMANN pince à pansements ..	62
blépharostat .....	178	NEIVERT COTTLE		PENFIELD dissecteur .....	170
blépharostat .....	178	écarteur double .....	227	PENNINGTON pince hémostatique .	46
MENGHINI aiguille à biopsie .....	91	porte-aiguille .....	92	perce-crâne, SMELLIE .....	305
seringue d'aspiration .....	91	NELSON aiguille à ligatures .....	98	PERCY retracteur a amputation ...	133
trocart p. deuxième ponction ...	91	pince à dissection .....	37	perforateurs à main .....	134-136
méniscotome, BIRCHER .....	131	trocart thoracique .....	90	perforateur à ongles .....	133



	Page		Page		Page
perforateur av. mandrin Jacobs	136	BERKE musculaire	191	DOYEN à champs	59
perforateur, BUNNELL à main	135	BERNHARD à champs	59	DOYEN intestinales	260
CUSHING, plat	134	BEST intestinale	263	DOYEN à polypes utérins	288
HUDSON	134	BEYER emporte-pièce	218	DUPLAY utérine	286
KIRSCHNER avec guide		pince à biopsie et à coagulation	243	DUVAL à tissus	36
téléscopique	135	pince à biopsie flexible	242	DUVAL p. tissus et intestins	260
KOCHER spatule à goitre	247	bipolaire à coagulation	316-318	ELSCHNIG à fixation	192
KUENTSCHER	143	BISHOP HARMAN à iris	190	ELSCHNIG capsulaire	193
MOORE à main	134	BLAKE à calculs biliaires	256	EPPENDORFER	
PERTHES	138	BLOHMKE a préhension		à biopsie utérine	295,296
RALK	135	amygdalienne	237	pince étroite à dissection	34
STILLE à main	134	BLUMENTHAL, gouge	109	FAURE à biopsie utérine	291
STILLE SHERMAN à main	134	BOEHLER coupante, à os	113	FAURE à péritoine	56
périostotome, COTTLE	222	Bonn iris	190,191	FEHLAND intestinale	263
JOSEPH	222	BOZEMANN à pansements	63	FERRIS SMITH KERRISON	
PERTHES perforateur	138	BOZEMANN DOUGLAS		à lames intervertéb	174
PESTALOZZA curette		à pansements	63	FERRIS SMITH à dissection	36
à faux germes	304	BRAUN utérine	286	FERRIS SMITH à laminectomie	173
PETRI boîte	310	BROWN dentelée	35	pincés flexibles	242-242
PHANEUF pince à peritoine	56	BRUENINGS coupante nasale	215	FOERSTER à éponges	61
picks	210,211	BRUNNER intestinale	263	FRAENKEL à polypes	
BARBARA	210,211	BRYANT à pansement	62	laryngiens	239
PIERCE trocart sinus maxillaire	90	BURKE a biopsie utérine	294	FRAENKEL, embout de	240
Pierre, Arkansas à repasser	16	CASTROVIEJO à fixation	192	FUCHS capsulaire	193
PIFFARD curette pour lupus	306	CASTROVIEJO capsulaire	193	GAUSS péricranienne	303
PINARD stéthoscopes	5	CASTROVIEJO à suture	194	GELLHORN à biopsie	292
pincés à champs	59	CHAPUT hémostatique	47	Gemini à dissection	
pince à couper et plier le fil	141	CHEATLE à instruments	105	et à ligature	49
pincés à dissection	34-37	CHERON à pansements	62	Gemini mini à dissection	
pincés à échardes	38	CHEVALIER JACKSON,		et à ligature	49
pince à échardes avec loupe	38	lar./bronch./œsoph	241	GERALD à dissection	37
pince à envies	307	CHILDE p. bords de la plaie	104	GILL à iris	188
pince à épiler les cils	197	CITELLI emporte-pièce	218	GILL ARRUGA capsulaire	192
pince à ongles	307	COLCLOUGH à disques		GILL HESS à iris	188
pince à poser clips YASARGIL	177	intervertébraux	175	GILLIES à dissection	37
pince à séquestres	117	COLLIN à pansements	62	GRADLE à épiler les cils	197
pince à stérilisation	105	COLLIN DUVAL à saisir tissus	36	GRAEFE	35
pince, ADLERKREUTZ	36	COLLIN hémostatiques	47	GRAEFE à fixation	192
ADSON à dissection	35	COLLIN hystérolabe	288	GREEN à fixation	192
ADSON à hypophyse	170	COLLIN pour agrafes	104	GREVEN à fil métallique	206
ADSON baby hémostatique	48	COLLIN tirelangue	231	GROSS MAIER à pansements	60
ADSON BROWN à dissection	35	COLVER à préhension		GUYON à pédicule rénal	55
ADSON hémostatique	48	amygdalienne	236	HAJEK CLAUS sinus maxillaire	218
ADSON micro, à dissection	35	COOLEY Atrauma	40	HAJEK KOFLER sinus maxillaire	218
ALEXANDER à biopsie	292	CORDES, embout de	240	HALSTED micro mosquito	43
ALLIS ADAIR à intestins	259	pince à corps étrangers	244	HALSTED mosquito	43
ALLIS baby à intestins	259	COS à fil métallique	206	HALSTED TITAN mosquito	43
ALLIS à intestins	259	COTTLE KAZANJIAN		HARRINGTON bronchique	254
ARRUGA capsulaire	193	coupante pour os	113	HARTMANN auriculaire	204
ASCH pour redresser la cloison	228	pince coupe-fil	142	HARTMANN coupante nasale	217
pincés auriculaires	204-209	CRILE hémostatique	45	HARTMANN hémostatique	42
AYER à chalazion	195	CRILE RANKIN hémostatique	45	HARTMANN HOFFMANN	
BABCOCK à intestins et tissu	259	CRILE TITAN hémostatique	45	auriculaire	204
BACKHAUS à champs	59	CUSHING à dissection	35	HARTMANN polypes nasaux	214
BAGGISH à biopsie utérine	295	CUSHING à laminectomie	172	HARTMANN WULLSTEIN	
BAINBRIDGE hémostatique	53	DANDY hémostatique	46	auriculaire	204
BALLENGER à préhens.		DARTIGUES hystérolabe	288	HAUGH auriculaire	206
amygdalienne	237	DAVIS à saisir les seringues	105	HEANEY à hystérectomie	57
BARRAQUER à épilation	197	DEBAKEY Atrauma	40	HEISS hémostatique	48
BARRAQUER à fixation	192	DeMARTEL WOLFSON à fermer	264	HERRICK à pédicule rénal	56
BARRAQUER p. la chambre		DeMARTEL WOLFSON		HESS à iris	188
antérieure	191	à anastomose	264	HESS capsulaire	193
BARRAQUER Colibri à iris	189	DESJARDINS à calculs biliaires	256	HEYMANN coupante nasale	215
BARRAQUER KATZIN à iris	189	DESMARRES à chalazion	195	HEYMANN KNIGHT	
BARRETT utérine	286	DeVILBISS craniale	169	coupante nasale	215
BEER à épiler les cils	197	DIETER coupe-mallet	206	HEYWOOD SMITH	
BENGOLEA hémostatique	48	DOUGLAS à épiler	197	hémorroïdale	275



	Page		Page		Page
HOLTH p. capsulotomie		MAYO GUYON à pédicule rénal	55	ROEDER à champs	59
et iridotomie	185	MAYO ROBSON intestinale	262	ROGGE a stérilisation	105
pince horloger	38	McCULLOUGH à strabisme	189	ROSENBERG, embout de	240
IOWA utérine	287	McGEE à fil métallique	206	ROWE, à disimpaction	234
JACKSON porte-tampons	239	McINDOE striée	36	RUBIN à cloison nasale	217
JACOBS utérine	287	McKENZIE à poser clips	166	RUMEL thoracique	50
JAMESON à strabisme	189	McPHERSON à ligature	194	RUSKIN gouge	111
JANSEN nasale	214	McPHERSON TITAN à ligature	194	RUSKIN LISTON	
JARCHO utérine	286	MEAD, gouge	109	coupante pour os	113
JATHO nasopharyngienne		MEEKER hémost./à dissect.		SAENGER à faux germes	304
coupante	228	/à ligature	52	SATINSKY anastomose	255
JOHNS HOPKINS hémost./		microchirurgicale	39	SAWTELL amygdalienne	236
conduit./à ligature	53	MIDDLETON JANSEN		SCHAEDEL à champs	59
JONES à champs	59	coupante, nasale	219	SCHEINMANN, embout de	240
JUDD ALLIS à intestins	259	MIKULICZ à péritoine	56	SCHNIDT amygdalienne	236
JUERS à fil métallique	206	MILLIN à capsule		SCHOENBURG p. saisir	
JURASZ à polypes laryngiens	239	prostatique atrauma	267	intestins	260
KALT capsulaire	193	MILLIN p. saisir		SCHROEDER utérine	286,287
KELLY hémostatique	45	lambeaux prostatiques	267	SCHUBERT à biopsie utérine	291
KELLY à polypes utérins	288	MILLIN porte-fil	267	SCHUMACHER	
KELLY RANKIN hémostatique	45	MIXTER à calculs biliaires	256	à biopsie utérine	293
KELLY TITAN hémostatique	45	MIXTER baby hémostatique	52	SCHUMACHER, embout de	240
KERRISON emporte-pièce	218	MIXTER hémost./		SCHWEIGGER capsulaire	193
KEVORKIAN à biopsie utérine	293	bronch./conductrice	53	scie a bagues	133
KEVORKIAN Pacific		MIXTER hémost./bronchique	52	SEIFFERT, embout de	240
à biopsie utérine	294	MIXTER O'SHAUGNESSY		SEMB coupante à os	114
KIRBY ARTHUR à iris	189	hémostatique	53	SEMKEN à dissection	37
KNAPP LUER p. granulations		pince modèle russe	36	pince serre-tubes	58
du trachome	195	MOYNIHAN à champs	59	SINGLEY	37
KNIGHT coupante nasale	215	MUSEUX utérine	287	SKENE utérine	286
KOCHER hémostatique délicate	45	MYLES coupante nasale	217	SMITHWICK à poser clips	166
KOCHER intestinale	261	NEGUS amygdalienne	236	SNELLEN entropion	195
KRAUSE, embout de	240	NELSON à dissection	37	SOMER hystérolabe	288
LAHEY à saisir le goitre	247	NOTO à polypes utérins	288	SPENCER WELLS hémostatique	46
LAHEY bronchique	254	NOYES à polypes nasaux	215	SPURLING à laminectomie	172
LAMBERT à chalazion	195	OLDBERG pour laminectomie	173	STAUDE MOORE utérine	286
LANE à dissection	36	OLIVECRONA TOENNIS		STILLE à dissection	34
LANE à champs	59	à poser les clips	166	STILLE à pédicule rénal	55
LANE à saisir les attelles	144	PAUFIQUE à ligature	194	STILLE HORSLEY	
LANGÉ, embout de	240	PEAN hémostatique délicate	45	coupante pour os	114
LAWRENCE hémost./		PEAN hémostatique	47	STILLE LISTON	
à dissect./à ligature	52	PELKMAN à pansements	62	coupante pour os	113
LERCHE à dissection	36	PENNINGTON hémostatique	46	STOCKMANN p. le pénis	270
LERICHE hémostatique	48	PHANEUF à péritoine	56	STONE à fermer pinces	
LESTER à fixation	192	pince plate	141	intestinales	263
LISTER (sinus) à pansement	62	POTTS SMITH à dissection	34	STONE WATT intestinale	263
LISTON coupante à os	113	PRATT hémostatique	47	STRAUSS p. le pénis	270
LITTAUER à épiler les cils	197	PRATT utérine	287	STRUEMPEL auriculaire	204
LITTAUER auriculaire	204	PRICE THOMAS p. les		STRUYCKEN nasale	217
LITTAUER à polypes nasaux	215	bronches	254	SWEET à poser clips	166
LORNA à champs	59	PRINCE musculaire	191	TEALE utérine	287
LOVE GRUENWALD		PROVIDENCE HOSPITAL		TERSON capsulaire	193
à laminectomie	172	hémostatique	44	THOMS ALLIS pour l'intestin	259
LOVELACE pulmonaire	254	RADOLF à extraire ongles	133	THOMS GAYLOR	
LOVELACE hémostatique	46	RAMPLEY à éponges	61	à biopsie utérine	292
LUBET BARBON		RANDALL à calculs rénaux	258	TILLEY auriculaire	204
à polypes nasaux	215	RANEY à poser et enlever		TISCHLER KEVORKIAN	
LUC coupante nasale	216	pince p.cuir chevelu	167	à biopsie utérine	295
LUCAE auriculaire	203	RANEY hémostatique		TISCHLER MORGAN à	
LURZ urétérale	258	pour cuir chevelu	167	biopsie utérine	293
MAGILL à introduire des sondes	8	ROBERTS hémostatique	50	TIVNEN a préhension	
MARSCHIK à amygdales	237	ROCHESTER CARMALT		amygdalienne	237
MARTEL p. le cuir chevelu	47	hémostatique	46	TOENNIS hémostatique	50
MARTIN à cartilages	117	ROCHESTER OCHSNER		TOWNSEND KEVORKIAN	
MASTIN musculaire	247	hémostatique	45	à biopsie utérine	294
MATHIEU à corps étrangers	269	ROCHESTER PEAN		TOWNSEND mini à biopsie	
MAYO BLAKE à calculs biliaires	256	hémostatique	45	utérine	295

	Page		Page		Page
TOWNSEND TISCHLER MORGAN		poignée avec mandrin Jacobs	136	pudendus, aiguille	
à biopsie utérine	294	POLITZER aiguille à paracentèse	202	p. anesthésie	91
TOWNSEND à biopsie utérine	294	insufflateur complet	201	PUTTI râpe à os double	132
TROELTSCH nasale	214	ponction lombaire, aiguille à	91	QUINBY ciseaux à gencives	29
TROUTMAN Colibri, à iris	189	FRAZIER tube gradué	171	QUIRE levier à corps étrangers	204
TROUTMAN rectus	191	MENGHINI, du foie, aiguille à	91	QUISLING marteau intranasal	125
Tübingen à ligatures	194	POOLE tube d'aspiration	8	RADOLF pince à extraire ongles	133
TUFFIER hémostatique	47	porte-agrales	166	RALK perforateur à main	135
TURNBULL à ongles	307	porte-aiguille, ADSON	94	rallonge, BRUENINGS, tube de	240
TUREL à biopsie rectale	275	ARRUGA	96	RAMPLEY pince à éponges	61
TYDING à préhension		BARRAQUER	97	RANDALL curette aspirante	
amygdalienne	237	BAUMGARTNER	92	à biopsie	29.0
ULRICH à tampons	60	BOYNTON	96	pince à calculs rénaux	258
pince universelle pour saisir	105	BOZEMANN	93	RANEY pince à poser	
pince USA à dissection	34	COLLIER	92	et enlever pinces	167
van DOREN à biopsie utérine	292	CRILE	94	pince hémostatique	
WAGNER à laminectomie	173	CRILE MURRAY	92	p. cuir chevelu	167
WALSHAM pour redresser		CRILE WOOD	92	râpe à os	132
la cloison	228	DE BAKEY	93	râpe, AUFRICHT nasale	224
WANGENSTEEN	37	DERF	92	FOMON nasale double	225,226
WEIL BLAKESLEY, nasale	216	DIETHRICH	96	GALLAHER p. le sinus	226
WERTHEIM a hystérectomie	57	FINOCHIETTO	94	JOSEPH (LEWIS) nasale	225
WERTHEIM CULLEN		HALSEY	92	MALTZ (COTTLE) nasale	225
à hystérectomie	57	HEANEY	93	PUTTI à os, double	132
WERTHEIM à hystérectomie	57	HOESEL	95	WIENER (AUFRICHT) nasale	225
WHITE à préhension		JAMISON	93	WIENER pour le sinus	225
amygdalienne	236	JOHNSON	94	râpe/lime à os	132
WILDE TROELTSCH auriculaire	203	KALT	97	rapprocheur, BAILEY baby,	
WILLET MARTEL p. le		KALT ARRUGA	97	des côtes	253
cuir chevelu	47	MASSON	93	BAILEY des côtes	253
WILLIAMS p. l'intestin	260	MATHIEU	95	BAILEY GIBBON des côtes	253
WINTER à faux germes	304	MAYO HEGAR	92	rapprocheurs des côtes	253
WITTNER à biopsie utérine	293	METZENBAUM	94	rasoir	16
YEOMAN à biopsie rectale	275	NEIVERT	92	rasoir, lames à microchirurgie	13
YOUNG à saisir la prostate	267	OLSEN HEGAR	95	RECAMIER curette utérine	299
YOUNG tirelangue	231	RYDER	93	réceptif cylindrique	310
PIPER forceps obstétrique	302	SAROT	94	règle graduée	7
PITHA bâillon en silicone	234	STEVENS	96	REICHERT dépresseur épiglottis	239
plaque condyalaire	159	STRATTE	94	REINER couteau à plâtre	108
plaque coudée	160	TOENNIS	94	seringue auriculaire	201
plaque à doigts	162,163	WANGENSTEEN	93	REVERDIN aiguille	99
plaque à ostéosynthèse	156-163	YOUNG boomerang	99	écarteur abdominal	66
plaque, JAEGER à paupières	179	porte-coton	89	REYNOLDS ciseaux	21
McLAUGHLIN	149	FARREL	89	rhachiotome	124
plaque mini doigt	163	JOBSON HORNE	89	RIBBON écarteur	66
plaque mini fragments	163	TOBOLD laryngien	89	RICHARDSON EASTMAN écarteur	66
plaque petits fragments	163	UCKERMANN	89	écarteur	66
plaque pour étendre la peau	15	POTTS DE MARTEL		RICHTER HEATH pince p. agrafes	104
SHERMAN pour os	164	ciseaux vasculaires	23	RIGBY écarteur, rectum, vagina	86
SMITH PETERSEN pour clou	149	SMITH ciseaux vasculaires	24	ROBERTS pince hémostatique	50
plateau à stériliser en		SMITH pince à dissection	34	ROCHESTER CARMALT	
fil métallique	312	PRATT écarteur cystique	274	pince hémostatique	46
plateau à stériliser en		pince hémostatique	47	OCHSNER pince hémostatique	45
tôle perforée	312	pince utérine	287	PEAN pince hémostatique	45
plateau pour instruments	310	spéculum rectal	272	ROEDER pince à champs	59
plâtre, BEESON écarteur à	108	PRICE THOMAS pince		ROGER élévateur pour la cloison	221
ciseaux à	30	clamp bronchique	254	ROGGE pince à stérilisation	105
ESMARCH couteau à	108	THOMAS pince pour bronches	254	ROLLET ciseau à extirpation	182
HAGLUND STILLE écarteur à	108	PRINCE ciseaux à amygdales	23	écarteur	182
HENNIG écarteur à	108	pince musculaire	191	rondelles pour vis	
HOPKINS couteau à	108	proctoscope, KELLY	274	à ostéosynthèse	152,153,155
REINER couteau à	108	protecteur, ARRUGA	184	rongeur, ADSON	110
scie électrique oscillante, à	107	protecteur de tissu		ROSE écarteur trachéal double	246
WOLFF pince à	108	p. vis à perf. longitud	145	ROSEN aiguilles	210,211
PLESTER couteau lobaire	210	PROVIDENCE HOSPITAL		couteau circulaire	210
écarteur	76	pince hémostatique	44	ROSENBERG embout de pince	240
plomb, main en	118			ROSER KOENIG ouvre-bouche	231

	Page		Page		Page
ROUX baby écarteur	64	couteau circulaire	210	SIEGLE spéculum auriculaire	198
écarteurs	64	SCHULTZE salpingographe	297	SILVER ciseau-burin	224
mini écarteur	64	SCHUMACHER ciseaux		SIMCOE canule à suture	196
ROWE pinces à désimpaction	234	à cordon ombilical	26	SIMON cuiller utérine	297
ruban métrique	7	embout de pince	240	curette tranchante à os	120
RUBIN pince à cloisin nasale	217	pince à biopsie	293	écarteur abdominal	74
rugine, ALEXANDER, raspatoire	126	SCHWEIGGER pince capsulaire	193	SIMPSON BRAUN forceps	
DOYEN costale	127	scie à bagues	133	obstétrique	300
FARABEUF	126	scie à plâtre		forceps obstétrique	300
KUHNT cornéenne	181	électrique oscillante	107	LUIKART forceps obstétrique	301
LAMBOTTE	126	scie, BERGMANN à plâtre	106	SIMS ciseaux utérins	25
LANGENBECK, raspatoire	126	CHARRIERE à amputation	133	curette utérine	299
MATSON à périoste	128	scie circulaire	138	dépresseur utérin	289
MATSON ALEXANDER	128	ENGEL à appareils plâtrés	106	dilatateur utérin	285
OVERHOLT à périoste	128	GIGLI manche pour,	169	hysteromètre	289
SEDILLOT	126	JOSEPH nasales	227	spéculum rectal	272
SEMB costale	127	LANGENBECK à doigts	133	spéculum vaginal	281
WILLIGER, raspatoire	126	OLIVECRONA en fil métallique	169	SINGLEY pince à dissection	37
RUMEL pince thoracique	50	SATTERLEE à amputation	133	SKENE pince utérine	286
RUSKIN LISTON		WIGMORE à plâtres	106	SLUDER BALLENGER	
pince coupante pour os	113	sclérotome,		amygdalotome	238
pince gouge	111	GUYTON LUNDSGAARD	181	SMELLIE crochet obstétrique	303
STILLE pince gouge	112	LUNDSGAARD	181	perce-crâne	305
RYDEL SEIFFER diapason	200	SEDILLOT rugine	126	SMILLIE méniscotomes	131
RYDER porte-aiguille	93	SEEMANN SEIFFERT		SMITH blépharostat	178
SAALFELD tire-comédons	306	ouvre-bouche	232	BUIE écarteur rectal	273
SACHS dissecteur à duremère	169	SEGOND évideur de fibromes	296	FERRIS pince à dissection	36
écarteur de nerfs	168	SEIFFERT embout de pince	240	FERRIS pince à laminectomie	173
SAENGER pince à faux germes	304	SEEMANN ouvre-bouche	232	HEYWOOD pince	
SANVENERO ciseaux	21	SELLHEIM levier p. abaisser		hémorroïdale	275
SAROT clamp bronchique	255	la tête	305	PETERSEN ciseau-burin	122
pince clamp bronchique	51	SEMB clamp bronchique	255	PETERSEN gouge	122
porte-aiguille	94	davier porte-os	114	PETERSEN plaque à os	149
SATINSKY ciseaux thoraciques	27	pince coupante à os	114	POTTS ciseaux vasculaires	24
pince à anastomose	255	pince gouge	113	POTTS pince à dissection	34
SATO couteau cornéen	181	rugine costale	127	US Army ciseaux à gaze	29
SATTERLEE scie à amputation	133	SEMKEN pince à dissection	37	SMITHWICK écarteur de nerfs	168
SAUERBRUCH boîte à aiguilles	308	SEMM spéculum	277	pince à poser les clips	166
costotome	249	SENN écarteur double	66	SNELLEN anse	184
écarteur	75	GREEN écarteur	69	pince à entropion	195
FREY costotome	249	sensimètre, WARTENBERG	7	SOMER pince hystérolabe	288
pince gouge	112	séquestres, pince à	117	sonde à mesurer	
SAWTELL pince amygdalienne	236	VAN BUREN, pince à	117	prothèse du tympan	211
SCAGLIETTI pince gouge	112	seringue amygdalienne	238	sonde, BAKES à calculs biliaires	257
scarificateur, GRAEFE	180	seringue, MENGHINI d'aspiration	91	BRUNNER conductrice	100
SCHAEDEL pince à champs	59	REINER auriculaire	201	ciseaux à entérotomie	28
SCHAMBERG tire-comédons	306	serre-fine, DIEFFENBACH	42	COXETER prostatique	271
SCHEDE curette tranchante	119	JOHNS HOPKINS	42	DESJARDINS à calculs biliaires	257
SCHEIE canule ophtalmique	196	serre-liens, PARHAM	118	HARTMANN auriculaire	202
couteau à goniectomie	181	serre-nœud, BRUENINGS		ITARD auriculaire	202
SCHEINMANN embout de pince	240	à amygdales	237	KILLIAN à irrigation	219
SCHIMMELBUSCH boîte		EVES à amygdales	237	KIRSCHNER conductrice	100
à stérilisation	311	KRAUSE nasal	219	KOENIG conductrice	100
SCHINK dermatome	15	TYDING à amygdales	238	MAYO à calculs rénaux	258
SCHIOETZ tonomètre	197	WILDE nasal	219	sonde métal pour femmes	271
SCHMIEDEN PAYR		serre-tubes	58	sonde métal pour hommes	271
sonde conductrice	100	serrenœud, KRAUSE auriculaire	203	MOYNIHAN à calculs biliaires	257
TAYLOR ciseaux à duremère	27	WESTON à polypes rectaux	275	OCHSNER à calculs biliaires	256
SCHNIDT pince amygdalienne	236	WILDE auriculaire	203	PAYR conductrice	100
SCHOENBORN écarteur		sets de diagnostic	3	SCHMIEDEN conductrice	100
à thyroïde	247	set pour otoscopie	3	SCHMIEDEN PAYR	
SCHOENBURG pince		SEXTON couteau auriculaire	202	conductrice	100
pour l'intestin	260	SHEA ciseaux micro	205	STACKE	
SCHROEDER pince utérine	286,287	SHERMAN plaque à os	164	auriculaire en argent	88
SCHUBERT pince à biopsie	291	STILLE perforateur à main	134	spatule à pommade	89
SCHUKNECHT couteau		vis à os	164	spatule, BANGERTER	
à serpette	210	SIEBOLD ciseaux gynécologiques	25	à cyclodialyse	184

	Page		Page		Page
CASTROVIEJO		costotome	248	UNNA	306
à cyclodialyse	184,185	GIERTZ costotome	249	WALTON	306
CUSHING cérébral	171	gouge	121	tire-veines	89
HEIFETZ cérébral	171	HAGLUND écarteur à plâtre	108	TISCHLER KEVORKIAN	
OLIVECRONA cérébral	171	HORSLEY pince		embout p. pince à biopsie	294
spéculum, ALAN PARKS rectal	273	coupante pour os	114	KEVORKIAN pince	
AUVARD vaginal	282	LISTON pince coupante pour os	113	à biopsie utérine	295
BARR rectal	272	LUER pince gouge	111	MORGAN embout à pince	
BODENHAMMER rectal	272	MAYO ciseaux	19	à biopsie utérine	294,296
BOUCHERON auriculaire	198	ostéotome	121	MORGAN pince a biopsie	
BREISKY vaginal	282	perforateur à main	134	utérine	293
BRUENINGS auriculaire	198	pince à dissection	34	TOWNSEND MORGAN pince	
CASPAR pour le lombaire		pince à pédicule rénal	55	à biopsie utérine	294
vertébral	82	pince à dissection	34	TIVNEN pince à préhension	
COLLIN vaginal	276	RUSKIN pince gouge	112	amygdalienne	237
COTTLE nasal	213	SHERMAN perforateur à main	134	TOBOLD abaisse-langue	230
CUSCO vaginal	276,277	STOCKMANN pince p. le pénis	270	porte-coton laryngien	89
CZERNY rectal	272	STONE pince à fermer les pinces	263	TOENNIS ADSON ciseaux	
DOYEN vaginal	281	WATT pince intestinale	263	neurochirurgicaux	26
GRAVE vaginal	276	WATT serrure seule	263	dissecteur à duremère	169
GRUBER auriculaire	198	strabisme, BONACCOLTO pince à	190	OLIVECRONA pince à clips	166
HARTMANN auriculaire	198	ciseaux à	22	pince hémostatique	50
HARTMANN HALLE nasal	212	DASTOOR pince à	190	porte-aiguille	94
JACKSON vaginal	281	GRAEFE crochet	182	tonomètre, SCHIOETZ	197
KALLMORGEN vaginal	280	JAMESON crochets	182	TOOK couteau cornéen	181
KILLIAN pour cloison	213	McCULLOUGH pince	189	TOTI fraise	137
KRISTELLER vaginal	278-280	STRATTE porte-aiguille	94	tournevis hexagonal	144
LANDAU vaginal	282	STRAUSS pince p. le pénis	270	tournevis, LANE	144
MATHIEU rectal	272	rectoscope	273	tournevis p. vis à perfor.	
PEDERSON vaginal	276	STRUEMPPEL pince auriculaire	204	longitudinale	145
PRATT rectal	272	STRULLY ciseaux		tourniquet „clip“	2
SEMM vaginal	277	neurochirurgicaux	26	TOWNSEND KEVORKIAN pince	
SIEGLE auriculaire	198	STRUYCKEN pince nasale	217	à biopsie utérine	294
SIMS vaginal	281	stylets et sondes	88	mini pince à biopsie utérine	294,295
SIMS rectal	272	stylet, BOWMAN lacrymal	186	TISCHLER MORGAN	
THUDICHUM nasal	212	DOYEN cannelé	88	pince à biopsie utérine	294
TIECK HALLE nasal	213	suture, MOORFIELD pince à	194	TOYNBEE spéculum auriculaire	198
TOYNBEE auriculaire	198	SIMCOE canule à	196	tracteur, BARTON	301
TRELAT vaginal	277	St. MARTIN pince à	194	CRUTCHFIELD,cranial	167
Vienne nasal	212	SWEET pince à poser les clips	166	DOYEN p. fibromes	296
YANKAUER pour le pharynx	214	TABB couteau à serpette	210	LUIKART BILL	302
SPENCER ciseaux à ligatures	28	taraud p. vis à perfor. longitudinale	145	TRAUBE marteau	6
WELLS pince hémostatique	46	TARNIER cranioclaste	305	TRELAT spéculum vaginal	277
SPRATT curette tranchante	119	forceps obstétrique	302	trépan, CASTROVIEJO	196
SPURLING pince à laminectomie	172	TAYLOR écarteur spinal	131	FRANCESCHETTI à keratomie	196
St. MARTIN pince à suture	194	marteau	6	KEYES cutanéen	306
STACKE sonde auriculaire		SCHMIEDEN ciseaux à duremère	27	trépan, ELLIOT jeu de	197
en argent	88	TEALE pince utérine	287	trocart abdominal	90
STAUDE MOORE pince utérine	286	tendeur à broches	140	trocart, COAKLEY sinus maxillaire	90
StCLAIR THOMSON		tendeur, LOUTE serre-fil	141	DOUGLAS,et canule	90
couteau à végétations	229	tensiomètres	1	FLEURANT p. la vessie	90
STEINMANN clou à os	139	TERSON pince capsulaire	193	LICHTWITZ sinus maxillaire	90
stérilisation, pince à	105	THOMAS PRICE pince clamp		NELSON thoracique	90
STERNBERG écarteur des lèvres	230	bronchique	254	OCHSNER thoracique	90
stéthoscope, BOWLES	5	PRICE pince bronchique	254	PIERCE sinus maxillaire	90
Duplex	5	THOMS ALLIS pince à intestins	259	UCKERMANN pour	
FORD	5	GAYLOR pince à biopsie	292	trachéotomie	245
FORD BOWLES	5	THOMSON StCLAIR couteau		TROELTSCH pince nasale	214
PINARD	5	à végétations	229	WILDE pince auriculaire	203
STEVENS ciseaux à ténotomie	22	WALKER écarteur vésical	268	TROEMNER marteau	6
crochet pour lentille cristalline	182	THOREK ciseaux pulmonaires	27	trousse a manucure pour infirmière	307
pince à iris	187	THUDICHUM spéculum nasal	212	trousse, NABATOFF à varices	88
porte-aiguille	96	TIECK HALLE spéculum nasal	213	TROUSSEAU dilateur trachéal	245
STEVENSON blépharostat	179	TILLEY pince auriculaire	204	TROUTMAN CHRIS casse-lames	13
STIEGLITZ pince à échardes	38	tire-clous, crochet	143	Colibri, pince à iris	189
STILLE ciseau-burin	121	tire-comédons, SAALFELD	306	pince rectus	191
ciseaux à plâtres	106	SCHAMBERG	306	tube, FRAZIER d'aspiration	171

	Page		Page		Page
WAGENER MOSHER .....	246	WEBER anse .....	184	couteau à iridectomie .....	180
Tübingen canule à air .....	196	WECKER ciseaux à iris .....	32	dilatateur lacrymal .....	186
Tübingen pince à iris .....	191	spatule pour l'iris .....	184	miroir frontal .....	4
Tübingen pince à ligatures .....	194	WEEK blépharostat .....	178		
TUFFIER écarteur .....	252	WEIL BLAKESLEY pince			
pince hémostatique .....	47	nasale coupante .....	216		
TURNBULL pince à ongles .....	307	WEITLANER écarteur .....	76		
TURREL pince à biopsie rectale ..	275	WULLSTEIN écarteur .....	76		
TYDING pince		WELLS spatule à enucléation ....	184		
à préhension amygdalienne ....	237	SPENCER pince hémostatique ..	46		
serre-nœud .....	238	WERTHEIM ciseaux à préparation ..	25		
UCKERMANN porte-coton .....	89	CULLEN pince à hystérectomie ..	57		
trocart .....	245	pinces à hystérectomie .....	57		
ULRICH pince à tampons .....	60	WEST ciseau-burin nasal .....	224		
universal ciseaux		gouge nasale .....	224		
à fil métallique .....	29	WESTCOTT ciseaux à tendons ....	32		
UNNA tire-comédons .....	306	ciseaux à iridectomie .....	39		
US Army écarteur double paire ....	65	WESTON serrenœud			
SMITH Army ciseaux à gaze ....	29	à polypes rectaux .....	275		
valve, BALFOUR centrale .....	84	WHEELER couteau à discision ...	180		
CASPAR .....	80,82	spatule à cyclodialyse .....	185		
CLOWARD .....	79	WHITE pince à préhension			
KALLMORGEN vaginale .....	280	amygdalienne .....	236		
KRISTELLER vaginale ....	278-280	WHITEHEAD ouvre-bouche .....	232		
van BUREN pince à séquestres ...	117	WIEDER abaisse-langue .....	230		
van DOREN pince		WIENER (AUFRIEHT) râpe nasale ..	225		
à biopsie utérine .....	292	crochet à iris .....	182		
VANNAS ciseaux à iridectomie ....	33	râpe pour le sinus maxillaire ...	225		
Varifocal ophtalmoscope .....	2	WIGMORE scie à plâtres .....	106		
vBUREN bougie dilatatrice .....	271	WILDE serre-nœud nasal .....	219		
VERBRUGGE davier porte-os ....	116	serrenœud auriculaire .....	203		
VERRES aiguille à pneumopéritoine .	91	TROELTSCH pince auriculaire ..	203		
Vienne spéculum nasal .....	212	WILDER anse .....	184		
vis à compression .....	151	dilatateur lacrymal .....	186		
VIRCHOW burin p. crâne .....	124	WILLET MARTEL pince			
couteau à cartilages .....	16	pour le cuir chevelu .....	47		
VIRTUS (RALK) pince à échardes ..	38	WILLIAMS blépharostat .....	178		
vis à perforation longitudinale ....	152	pince pour les intestins .....	260		
vis corticale .....	153/154	WILLIGER curette double .....	120		
vis dynamique à fémur .....	151	marteau .....	125		
vis malléolaire .....	154	rugine raspatoire .....	126		
vis mini à ostéosynthèse .....	153	WINTER pince à faux germes ....	304		
SHERMAN .....	164	WITTNER pince à biopsie utérine ..	293		
vis à spongieuse .....	153-155	WOLFF pince à plâtre .....	108		
VOLKMANN curette		WOOD CRILE porte-aiguille .....	92		
tranchante .....	119,120	WRIGLEY forceps obstétrique ....	300		
écarteur .....	69,70	WULLSTEIN ciseaux micro .....	207		
VOLTOLINI spéculum nasal .....	212	couteau à serpette .....	210		
vPETZ appareil à sutures		HARTMANN pince auriculaire ..	204		
intestinales .....	266	WEITLANER écarteur .....	76		
WACHENFELDT agrafes .....	104	WYLIE dilatateur utérin .....	285		
pince pour agrafes .....	104	YANKAUER spéculum pour			
WADSWORTH TODD cautère ....	184	le pharynx .....	214		
WAGENER crochet .....	203	tube d'aspiration .....	8		
MOSHER tube auriculaire .....	246	YASARGIL clips			
WAGNER ciseaux .....	29	neurochirurgicaux .....	176,177		
pince à laminectomie .....	173	YEOMAN pince à biopsie rectale ..	275		
WALLICH cuiller à faux germes ...	304	YOUNG aiguille de rechange .....	99		
WALSHAM pince à		boomerang porte-aiguille .....	99		
redresser la cloison .....	228	écarteur prostatique .....	267		
WALTON gouge à corps étrangers .	182	pince à saisir la prostate .....	267		
tire-comédons .....	306	pince tirelangue .....	231		
WANGENSTEEN pince .....	37	ZAUFAL JANSEN pince gouge ...	111		
porte-aiguille .....	93	ZENKER pince à dissection			
WARTENBERG sensimètre .....	7	et à ligatures .....	51		
WATSON CHEYNE		ZIEGLER blépharostat .....	179		
élévateur double .....	129	couteau à capsulotomie .....	181		



## Tabla del contenido

Grupo		Página
102	Diagnóstico	1- 7
104	Anestesia	8- 9
106	Bisturíes, Cuchillos	10- 16
108, 109	Tijeras	18- 33
110, 111	Pinzas de disección	34- 40
112	Pinzas hemostáticas	42- 57
112	Pinzas para tubos	58
114	Pinzas para campos	59
116	Pinzas para pólipos y esponjas	60- 63
118	Separadores	64- 87
120	Estiletes, Sondas, Porta-algodón	88- 89
122	Trócares, Aguja para punción	90- 91
124, 126	Sutura	92- 104
128	Auxilios para la esterilización	105
130	Vendajes enyesados	106- 108
132 -136	Cirugía ósea, osteosíntesis	109- 166
140	Neurocirugía, Laminectomía	167- 177
142	Oftalmología	178- 197
144	Otología	198- 211
146	Rinología	212- 229
148	Boca y lengua	230- 234
150	Amígdalas	235- 238
152	Laringe	239- 241
153	Pinzas flexibles endoscópicas	242- 244
154	Traquetomía	245- 246
154	Bocio	247
156	Tórax	248- 255
162	Vesícula biliar	256- 257
164	Riñón	258
164	Intestinos, Estómago	259- 266
166	Urología	267- 271
168	Recto	272- 275
170	Ginecología	276- 299
172	Obstetricia	300- 305
174	Dermatología, Higiene	306- 307
188	Contenedores y bandejas	308- 312
190	Cirugía de alta frecuencia	314- 319

	Página		Página		Página
abajalengua, ANDREW	230	ALEXANDER cincel	121	GIBBON aproximador	
BRUENINGS	230	gubia	121	de costillas	253
BUCHWALD	230	MATSON periostótomo	128	BAINBRIDGE pinza hemostática	53
FRENZEL	230	periostótomo	126	BAKES sonda para	
HARTMANN	230	pinza p. biopsia	292	cálculos biliares	257
abajalengua de madera	230	alicate plana	141	BALFOUR baby separador	
TOBOLD	230	ALLIS ADAIR pinza		abdominal	84
WIEDER	230	para intestinos	259	BALLENGER cuchillo	
abreboca, DAVIS BOYLE	232	baby pinza para		p. vegetaciones	221
DENHART	231	intestinos y tejidos	259	elevador p. tabique	222
DOYEN JANSEN	231	JUDD pinza para intestinos	259	HAJEK elevador p. tabique	222
HEISTER	231	THOMS pinza para intestinos	259	pinza p. coger amígdalas	237
JENNINGS	232	ALLISON espátula pulmonar	253	SLUDER amigdalótomo	238
KILNER DOUGHTY	233	ALM separador	76	bandeja p. esterilizar	
McIVOR	233	ALVIS cureta p.		instrumentos	312
ROSER KOENIG	231	cuerpos extranjeros	182	bandeja p. instrumentos	310
SEEMANN SEIFFERT	232	amigdalótomo,		BANGERTER espátula	
WHITEHEAD	232	SLUDER BALLENGER	238	p. ciclodíalisis	184
ADLERKREUTZ pinza de disección	36	amniótomo, BEACHAM	289	BARANY ensordecedor	200
ADSON baby pinza hemostática	48	amputación,		BARBARA aguja	210
baby separador	77	CHARRIERE sierra para	133	ganchito	210
BROWN pinza de disección	35	cuchillo para	15	pick	210,211
elevador	128	LISTON cuchillo para	15	BARKAN cuchillo p. goniomía	181
micro pinza	35	PERCY retractor para	133	BARNHILL cucharilla	
micro pinza de disección	35	ANDREW abajalengua	230	p. vegetaciones	229
pinza de disección	35	anoscopio, HIRSCHMANN	274	BARR espéculo rectal	272
pinza gubia	110	IVES FANSLER	274	barra, GERSTER de tracción	118
pinza hemostática	48	aparato de compresión completo	132	BARRAQUER Colibri blefarostato	178
pinza pituitaria	170	aparato, vPETZ		Colibri pinza para iris	189
porta aguja	94	p. suturas intestinales	266	Colibri tijeras para iris	32
separador	77	aproximador, BAILEY baby,		cuchillo p. queratoplástica	181
separador duramadre	168	de costillas	253	KATZIN pinza para iris	189
TOENNIS tijeras		BAILEY de costillas	253	pinza para cámara anterior	191
neuroquirúrgicas	26	BAILEY GIBBON de costillas	253	pinza de fijación	192
tubo de aspiración	171	aproximador de costillas	253	pinza depilatoria	197
AEBLI tijeras corneales	22	arandela p. tornillos		porta aguja	97
aguja BARBARA	210	de osteosíntesis	152,153,155	barrena hueca	145
COOPER para ligaduras	98	ARCHER pinza para espinas	38	BARRETT pinza uterina	286
aguja de inyección		Arkansas piedra de afilar	16	BARTON fórceps obstétrico	301
para amígdalas	238	ARRUGA blefarostato	178	tractor para fórceps	
DESCHAMPS para ligaduras	98	gancho para extracción	182	obstétricos	301
DUPUY WEISS para amígdalas	236	GILL pinza capsular	192	BAUMGARTNER porta aguja	92
FRANKE para tomar sangre	2	KALT porta aguja	97	BEACHAM amniótomo	289
FRANKLIN SILVERMANN,		pinza capsular	193	BECKER quistótomo	182
punción del hígado	91	porta aguja	96	BECKMANN cucharilla	
aguja intestinal, p. suturas	103	protector	184	p. vegetaciones	229
KEITH para suturas	103	asa, BILLEAU auricular	203	EATON separador	78
KOENIG para suturas	103	con imán oculístico	197	separador	78
KRONECKER para ligaduras	98	SNELLEN	184	BEEBEE tijeras	29
LICHTWITZ para		WEBER	184	BEER pinza depilatoria	197
punción del seno maxilar	219	WILDER	184	BEESON separador. p. yesos	108
MENGHINI para la		asas para cierranudos	203,219,237	BELLUCCI tijeras	
biopsia del hígado	91	ASCH pinza para		microquirúrgicas	205
NELSON para ligaduras	98	enderezar tabique nasal	228	BENGOLEA pinza hemostática	48
aguja para anestesia de pudendus	91	aspirador, DASTOOR,capsular	185	BENNETT elevador p. huesos	129
aguja para catarata	181	AUFRIEHT lima nasal	224	BERENS querátomo	180
aguja para cuerpos extranjeros	181	separador nasal	227	BERGMANN sierra para yesos	106
aguja para punción lumbar	91	autopsia, juego de instrumentos	124	tijeras para vendajes	30
POLITZER de paracentesis	202	AUVARD espéculos vaginales	282	BERKE pinza muscular	191
REVERDIN para suturas	99	AXENFELD cucharilla p. chalazión	183	BERLINER martillo	6
ROSEN para oídos	210	AYER pinza p. chalazión	195	BERNHARD pinza para campos	59
aguja para suturas	102,103	BABCOCK pinza para intestinos	259	BERTILLON cefalómetro	7
VERRES para el neumoperitoneo	91	BABINSKY martillo	6	BEST pinza intestinal	263
YOUNG de repuesto	99	BACKHAUS pinza para campos	59	BETHUNE costótomo	249
ALAN PARKS adaptador luz fría	273	BAGGISH pinza biopsia uterina	295	BEUSE tijeras	23
PARKS espéculo rectal	273	BAILEY aproximador de costillas	253	BEYER pinza gubia	111
ALBEE fresas	137	baby aproximador de costillas	253	pinza sacabocado	218

	Página		Página		Página
BILL LUIKART tractor		BOUCHERON espéculo auricular	198	CARMALT pinza para espinas	38
p. fórceps obstétricos	302	BOWLES estetoscopio	5	ROCHESTER pinza hemostática	46
tractor p. fórceps obstétricos	302	FORD estetoscopio	5	CARPENTER cuchillo	
BILLEAU asa auricular	203	BOWMAN aguja p. discisión	181	p. amígdalas y disecador	235
bipolar, pinza	316-318	blefarostato	178	cuchillo p. amígdalas	
BIRCHER GANSKE		cuchillo de discisión	180	y enucleador	235
pinza p. huesos	117	sonda lacrimal	186	CASPAR espéculo lumbar vertebral	82
meniscótomo	131	BOYNTON porta aguja	96	separadores	80-82
BISHOP HARMAN pinza para iris	190	BOZEMANN DOUGLAS		separador para laminectomía	81
bisturí, CONVERSE		pinza p. pólipos	63	separador p. tejido blando	80
para plástica nasal	220	porta aguja	93	valvas	80,82
COTTLE para plástica nasal	220	BRAUN cranioclasto	305	CASTAÑEDA ALU separador	
bisturí desechable estéril	12	depresor uterino	289	para costillas	252
FREER p. mucosa	220	gancho de decapitación	305	CASTROVIEJO blefarostato	179
HALLE p. duramadre	170	pinza uterina	286	compás marcador	185
hoja de, estéril	11	SIMPSON forceps obstétricos	300	dilatador lacrimal	186
JOSEPH nasal	220	STADLER tijeras p. episiotomía	26	espatula para ciclodíalisis	184,185
bisturí con mango de metal	14	BREISKY espéculo vaginal	282	pinza capsular	193
PARKER fino	14	BROWN ADSON pinza		pinza de fijación	192
SEGOND p. fibroma	296	de disección	35	pinza para suturas	194
bisturíes, mangos para hojas	10	BRUENINGS abajalengua	230	porta aguja	97
BLAKE cureta doble	297	cierranudos para amígdalas	237	querátomo	180
MAYO pinza para		cuchillo p. tabique nasal	221	rompe hojas	13
cálculos biliares	256	espatula auricular neumático	198	tijeras corneales	33
blefarostato, ARRUGA	178	pinza cortante nasal	215	tijeras de iridectomía	32
BARRAQUER Colibri	178	punta de pinza laríngea	240	trefinas corneales	196
BOWMAN	178	tubos de extensión	240	catarata, agujas para	181
CASTROVIEJO	179	BRUNETTI cincel espinal	124	GRAEFE cuchillo para	179
CLARK	178	BRUNNER conductor		cateter, COXETER prostático	271
CRITCHETT	178	de madera artificial	100	HARTMANN auricular	202
GOLDSTEIN	179	costótomo	249	ITARD auricular	202
GRAEFE	178	pinza intestinal	263	MAGILL pinza para introducir	8
LANCASTER	179	sonda conductora	100	cateter metal p. hombre	271
LISTER BURCH	178	BRUNS cucharilla cortante	119,120	cateter metal p. mujer	271
MELLINGER	178	tijeras p. vendajes	30	cefalómetro, BERTILLON	7
MELLINGER AXENFELD	178	BRYANT pinza para medicación	62	CHAPUT pinza hemostática	47
MUELLER	179	BUCHWALD abajalengua	230	CHARRIERE sierra p. amputación	133
MURDOCK	178	BUCK cuchillo auricular	202	CHEATLE pinza p.	
PARK	179	cureta auricular	201	instrumentos esterilizados	105
SMITH	178	elevador para		CHERON pinza para pólipos	62
STEVENSON	179	cuerpos extranjeros	204	CHEVALIER JACKSON	
WEEK	178	martillo de percusión	6	pinzas endoscópicas	241
WILLIAMS	178	BUIE SMITH separador rectal	273	CHILDE pinza p. borde de herida	104
ZIEGLER	179	tubo de aspiración	275	cierranudos, BRUENINGS	
BLOHMKE pinza p. coger		bujía, GUYON dilatadora	271	para amígdalas	237
amígdalas	237	vBUREN dilatadora	271	EVES para amígdalas	237
BLOUNT elevador p. huesos	131	BUMM cureta uterina	299	KRAUSE auricular	203
separador para rodilla	131	BUNGE cucharilla		KRAUSE nasal	219
BLUMENTHAL pinza gubia	109	p. exenteración	183	WESTON, para pólipos rectales	275
BODENHAMMER espéculo rectal	272	BUNNELL perforador a mano	135	WILDE auricular	203
BOEHLER clavo para huesos	149	separador para tendones	132	WILDE nasal	219
estribo de extensión	140	BUNT clip p. esterilizar pinzas	105	cincel, ALEXANDER	121
pinza cortante p. huesos	113	BURCH horquilla fijadora	181	BRUNETTI espinal	124
pinza gubia	111	LISTER blefarostato	178	CINELLI p. plástica	223
BOERMA fórceps obstétricos	302	BURKE pinza sacabocados		COTTLE p. plástica. grad	223
BOETTCHER tijeras p. amígdalas	23	p. biopsia uterina	294	DIX y aguja	185
bombilla de repuesto p.		BUSCH tijeras p. cordón umbilical	26	FOMON	223
laringoscopios	9	caja de cristal con tapa	308,309	FREER para tabique nasal	222
bombilla de repuesto		caja para agujas	308	HIBBS	123
p. lámpara CLAR	4	campos, pinzas para	59	HOKE	123
BONACCOLTO pinza p.		cánula, Bonn p. irrigación	196	LEXER	123
estrabismo	190	DOUGLAS y trocar	90	LEXER mini	123
Bonn cánula p. irrigación	196	Hamburg abotonada	196	cincel p. huesos	121
Bonn pinza para iris	190,191	KILLIAN p. irrigación	219	PARTSCH	121
BORCHARDT fresa olivar	137	SCHEIE oftalmológica	196	PASSOW hemostático	211
BOSE gancho traqueal	245	SIMCOE para sutura	196	ROLLET para extirpación	182
separador traqueal	245	Tübingen para aire	196	SILVER para plástica	224

	Página		Página		Página
SMITH PETERSEN	122	UNNA saca-	306	DESJARDINS para	
STILLE	121	WALTON saca-	306	cálculos biliares	257
WEST nasal	224	compresión, aparato de	132	GRAEFE p. catarata	183
CINELLI cincel p. plástica	223	tornillo de	151	HALLE maleable	120
cinta frontal	4	compresor, CORWIN		HARTMANN pinza auricular	204
cinta métrica	7	p. amígdalas	237	HEBRA p. chalazión	183
PARHAM para huesos	118	CONNIN AMSLER marcador	185	LEMPERT	120
CITELLI pinza sacabocado	218	CONVERSE bisturí para		MAYO para cálculos biliares	257
clamp, COLLIN umbilical	303	plástica nasal	220	MEYHOEFER p. chalazión	183
CRAFOORD pinza bronquial	51	COOLEY Atrauma pinza	40	PLESTER lobar	210
DEBAKEY Bulldog atrauma	41	COOPER aguja	98	SCHUDE cortante	119
DESJARDINS para		copa graduada	310	SIMON cortante	120
conducto biliar	54	CORDES punta de pinza laríngea	240	VOLKMANN cortante	119,120
FERGUSSON pinza de		cordótomo, FRAZIER	170	ZIEGLER para capsulotomía	181
presión progresiva	46	corta-callos, Credo	307	ZIEGLER para iridectomía	180
FINOCHIETTO bronquial	254	corta-ligadura	244	cuchillo,	
GLOVER cardiovascular atrauma	41	CORWIN compresor p. amígdalas	237	BALLENGER p. vegetaciones	221
GRAY p. conducto biliar	54	CORYLLOS costótomo	249	BARKAN p. goniectomía	181
GREEN ARMYTAGE		separador torácico	75	BARRAQUER	
pinza uterina	303	COS pinza para doblar hilo	206	p. queratoplástica	181
KANE umbilical	303	costótomo	248,249	BOWMAN para discisión	180
LAMBERT LOWMAN p. huesos	118	COTTLE bisturí p. plástica nasal	220	BRUENINGS para tabique	221
LANE pinza estomacal	265	cincel p. plástica	223	BUCK auricular	202
LOWMAN p. huesos	118	cincel p. plástica nasal	220,223	COTTLE para plástica nasal	220
MOYNIHAN pinza	54	elevador p. tabique nasal	222	DEUTSCHMANN para catarata	179
PAYR baby pinza intestinal	266	espéculo nasal	213	ELSCHNIG corneal	181
PAYR pinza intestinal	266	KAZANJIAN pinza corta hueso	113	ESMARCH p. yeso	108
SAROT pinza bronquial	51	NEIVERT separador doble	227	FREER para tabique nasal	220
CLAR lámpara frontal	4	periostótomo	222	GILL corneal	181
mini lámpara frontal	4	separador	227	HOPKINS p. yeso	108
CLARK blefarostato	178	tijeras nasales	23	LANGENBECK p. resección	15
clavo, BOEHLER, para huesos	149	COXETER cateter prostático	271	MUCK p. periostio	211
clavo con gancho	146	CRAFOORD pinza clamp bronquial	51	cuchillo p. cerebro	16
JEWETT	150	tijeras pulmonares	27	cuchillo para amputación	15
KUENTSCHER	147,148	Credo corta-callos	307	PAUFIQUE p. queratoplástica	181
SMITH PETERSEN	149	CRILE MURRAY porta aguja	92	REINER p. yeso	108
STEINMANN	139	pinza hemostática	45	ROSEN circular	210
CLEVELAND pinza gubia	109	porta aguja	94	SATO corneal	181
clip, YASARGIL		RANKIN pinza hemostática	45	SCHIE p. goniectomía	181
para aneurisma	176,177	separador doble	65	SCHUKNECHT circular	210
CLOWARD separador	79	TITAN pinza hemostática	45	SCHUKNECHT forma de hoz	210
separador vertebral	171	WOOD porta aguja	92	SEXTON auricular	202
valvas	79	CRITCHETT blefarostato	178	StCLAIR THOMSON	229
COAKLEY cureta para		CRUTCHFIELD perforador		TABB forma de hoz	210
seno maxilar	228	inicial	167	TOOK corneal	181
trocar para seno maxilar	90	tractor cranial	167	VIRCHOW para cartilago	16
COLCLOUGH pinzas sacabocado	175	cubeta, PETRI c. tapa	310	WULLSTEIN forma de hoz	210
COLLIER porta aguja	92	cubeta redonda	309	cuerpos extraños,	
COLLIN clamp umbilical	303	cuchara, CUZZI p. aborto	304	aguja para	181
dinamómetros	2	FERGUSSON p. cálculos		extranjeros, ALVIS,	
DUVAL pinza	36	biliares	257	cureta para	182
espéculo vaginal	276	GUTMANN p. secreciones	270	extranjeros, BUCK,	
HARTMANN separador	65	MAYO p. cálculos biliares	257	cureta para	204
histerómetro	289	MOORE p. cálculos biliares	256	extranjeros, DAVIS,	
mango de bisturíes	10	SIMON uterina cortante	297	aguja para	181
martillo	125	WALLICH p. aborto	304	extranjeros, DIX,	
pelvímetro	303	cucharilla, AXENFELD		cincel para	182
pinza hemostáticas	47	p. chalazión	183	extranjeros, ELLIS,	
pinza histerólabo	288	BARNHILL p. vegetaciones		gubia para	182
pinza para agrafes	104	adenoides	229	extranjeros, FRANCIS,	
pinza para pólipos	62	BRUNS cortante	120	aguja para	181
pinza tira-lengua	231	BUNGE p. exenteración	183	extranjeros, LEVINSON,	
separador abdominal	86,87	CARPENTER, y disecador		aguja para	181
COLLYER pelvímetro	303	para amígdalas	235	extranjeros, QUIRE,	
COLVER pinza p. coger amígdalas	236	CARPENTER, y enucleador		elevador para	204
comedones, SAALFELD saca-	306	para amígdalas	235	CULLER espátula para iris	184
SCHAMBERG saca-	306	DAVIEL p. catarata	183	cureta, BLAKE doble	297

	Página		Página		Página
BUCK auricular	201	DERF porta aguja	92	LANG, y cureta para	
BUMM uterina	299	dermatomo, SCHINK	15	saco lacrimal	184
COAKLEY para seno maxilar	228	DESCHAMPS aguja para ligaduras	98	PATON corneal	181
FAULKNER cortante	228	descolador, DAVIS		PENFIELD	170
FOX para lupus	306	para duramadre	169	disección, Gemini pinza,	
HOUSE doble	211	FISCH	211	y para ligaduras	49
KEVORKIAN para biopsia	290	MILLIGAN para duramadre	169	pinzas de	34-37
MARTINI doble	120	descolador p. duramadre	169	DIX aguja y cincel	185
NOVAK aspiradora para biopsia	290	SACHS para duramadre	169	aguja y gubia	185
PESTALOZZA para aborto	304	TOENNIS para duramadre	169	cincel p. cuerpos extranjeros	182
PIFFARD p. lupus	306	DESJARDINS clamp para		DOUGLAS BOZEMANN	
RANDALL aspiradora		conducto biliar	54	pinza p. pólipos	63
para biopsia	290	cucharilla para		pinza depilatoria	197
RECAMIER uterina	299	cálculos biliares	257	trocar y cánula	90
SIMS uterina	299	pinza para cálculos biliares	256	DOYEN baby pinza intestinal	260
VOLKMANN cortante		sonda para cálculos biliares	257	espéculo vaginal	281
para huesos	119,120	DESMARRES pinza chalazión	195	estilete acanalado	88
WILLIGER doble	120	separador (también de párpados)	69	fresas	137
CUSCO espéculo vaginal	277	desobliterador de vena	89	JANSEN abreboca	231
CUSHING espátula cerebral	171	destornillador hexagonal	144	periestótomos costal	127
gancho para nervios	168	destornillador, LANE	144	pinza intestinal	260
perforador plano	134	destornillador p. tornillos		pinza p. campos	59
pinza de disección	35	perforados longit	145	pinza para pólipos uterinos	288
pinza para laminectomía	172	WILLIAMS, y soporte	144	separador abdominal	74
separador	69	DEUTSCHMANN cuchillo		tijeras ginecológicas	25
CUZZI cuchara p. aborto	304	para catarata	179	tirabuzón p. fibroma	296
CZERNY espéculo rectal	272	DeVILBISS pinza craneana	169	DUBOIS tijeras ginecológicas	25
DANDY pinza hemostática	46	DEWEY fórceps obstétricos	302	DUPLAY pinza uterina	286
separador p. nervios	168	diagnóstico, juego	3	Duplex estetoscopio	5
tijeras neuroquirúrgicas	27	Diamant corta-hilos	142	DUPUY WEISS aguja	
DARLING separador	79	diapasón, aluminio	199	para amígdalas	236
DARTIGUES pinza histerólabo	288	HARTMANN	199	DUVAL COLLIN pinza	36
DASTOOR aspirador capsular	185	LUCAE	200	pinza	36
pinza para estrabismo	190	diapasón neurológico	200	pinza p. tejido	260
DAVIDSON separador		RYDEL SEIFFER	200	ECHLIN pinza gubia	112
para escápula	75	DIEFFENBACH serra-fina	42	Econom juego de diagnóstico	3
DAVIEL cucharilla p. catarata	183	DIETER pinza p. cabeza		Econom tensiómetro	1
DAVIS aguja p.		del martillo	206	electrodo de coagulación por	
cuerpos extranjeros	181	DIETHRICH porta agujas	96	alta frecuencia	314,315
BOYLE abreboca	232	dilatador, CASTROVIEJO lacrimal	186	elevador, ADSON	128
descolador de duramadre	169	GOODELL uterino	285	BALLENGER p. tabique	222
pinza p. coger jeringas	105	HANK uterino	285	BENNETT p. huesos	129
DAY gancho auricular	203	HEGAR	283,284	BLOUNT p. huesos	131
DE BAKEY porta agujas	93	KUENTSCHER, para el fémur	143	COTTLE p. tabique	222
de LEE fórceps obstétricos	300	LABORDE traqueal	245	FREER tabique	221
De MARTEL guía-sierra	169	SIMS uterino	285	HAJEK BALLENGER	
POTTS MARTEL		TROUSSEAU traqueal	245	para tabique	222
tijeras vasculares	23	vBUREN uretral	271	HENKE p. amígdalas	235
DEAN cuchillo para iris	180	WILDER lacrimal	186	HOHMANN p. huesos	129,130
tijeras para amígdalas	23	WYLIE uterino	285	KEY	128
DEAVER separador	67	ZIEGLER lacrimal	186	KILLIAN p. tabique	222
tijeras	19	corta-anillos	133	LANE p. doblar placas	144
DEBAKEY Atrauma pinza	40	diapasón aluminio	199	LANGENBECK	128
clamp Bulldog Atrauma	41	estuche de bolsillo standard	105	LEMPERT	211
tijeras vasculares/torácicas	24	imán oculístico con asa	197	McDONALD doble	129
tijeras vasculares	24	porta-algodón	89	MURPHY LANE doble	129
dedal, LANGENBECK	234	rompe hojas para microcirugía	13	elevador para huesos	130
DEJERINE martillo	6	separador	76	ROGER para tabique	221
DeMARTEL WOLFSON		tijeras p. vendajes, excéntricas	30	WATSON CHEYNE doble	129
pinza anastomosis	264	dinamómetro, COLLIN	2	ELLIOT forceps obstétricos	300
DeMARTEL WOLFSON		DINGMANN pinza para huesos	117	trefina	197
pinza p. cerrar pinzas	264	discisión, BOWMAN aguja para	181	ELLIS gubia p. cuerpos	
DeMARTEL WOLFSON		WHEELER cuchillo para	180	extranjeros	182
porta clamps	264	disco p. limitar corte	138	ELSCHNIG cuchillo corneal	181
DENHART abreboca	231	disecador, GREEN corneal	182	espatula para ciclodíalisis	184
depresor de lengua		HORSLEY, para duramadre	170	pinza capsular	193
KILNER DOUGHTY	233	HURD p. amígdalas	235	pinza p. fijación	192



	Página		Página		Página
EMMET gancho para fistulas	296	Viena modelo, nasal	212	FLEURANT trócar p. la vejiga	90
encías, QUINBY tijeras para	29	VOLTOLINI nasal	212	FOERSTER pinza p. esponjas	61
tijeras para	29	YANKAUER de faringe	214	pinza para iris	188
endospéculo, KOGAN	282	espejo laríngeo	241	FOMON cincel	223
ENGEL sierra p. vendajes		MICHEL	214	escofina nasal	226
enyesados	106	ZIEGLER frontal	4	lima nasal	225
ensordecedor, BARANY	200	espinas, pinzas para	38	separador p. alas	227
enterotomía, tijeras para	28	esterilizar, BUNT clip para	105	separador p. coanas	227
enucleación, tjeas para	22	pinzas para	105	tijeras nasales	22
EPPENDORFER KEVORKIAN		estetoscopios	5	fórceps, BARTON obstétricos	301
pinza p. biopsia uterina	296	estilete abotonado	88	BOERMA obstétricos	302
TISCHLER MORGAN pinza		estilete acanalado	88	de LEE obstétricos	300
p. biopsia uterina	296	estilete, DOYEN acanalado	88	DEWEY obstétricos	302
escarificador, GRAEFE	180	estilete mirtiforme	88	ELLIOT obstétricos	300
esclerótomo,		estrabismo, BONACCOLTO		KIELLAND LUIKART	
GUYTON LUNDSGAARD	181	pinza para	190	obstétricos	301
LUNDSGAARD	181	DASTOOR pinza para	190	KIELLAND obstétricos	300
escofina, FOMON nasal	226	GRAEFE gancho para	182	LUIKART obstétricos	301
ESMARCH cuchillo p. yeso	108	JAMESON gancho para	182	McLEAN obstétricos	301
tijeras para vendajes	30	tjeas para	22	McLEAN TUCKER obstétricos	301
espátula	89	estribos de extensión	140	NAEGELE obstétricos	300
espátula, ALLISON pulmonar	253	estuche para instrumentos	308	PIPER obstétricos	302
BANGERTER para ciclodíalisis	184	estuche p. sutura por agrafes	105	SIMPSON BRAUN obstétricos	300
CASTROVIEJO para		estuche p. suturas,		SIMPSON LUIKART obstétricos	301
ciclodíalisis	184,184	en estuche metálico	105	SIMPSON obstétricos	300
CUSHING cerebral	171	EVES cierranudos	237	TARNIER obstétricos	302
ELSCHNIG para ciclodíalisis	184	extensión, estribo de	140	WRIGLEY obstétricos	300
HEIFETZ cerebral	171	gancho para,	140	FORD BOWLES estetoscopio	5
KOCHER vesical	268	extractor, KUENTSCHER		estetoscopio	5
LEGUEU vesical	268	para clavos intramed	143	FOREGGER laringoscopio	8,9
OLIVECRONA cereberal	171	FARABEUF LAMBOTTE		FOX cureta para lupus	306
WELLS para enucleación	184	pinza p. huesos	115	FRAENKEL pinza p.	
WHEELER para ciclodíalisis	185	periostótomo	126	pólipos laríngeos	239
espéculo, ALAN PARKS rectal	273	pinza para huesos	114	punta de pinza laríngea	240
AUVARD vaginal	282	separador doble, pareja	64	FRANCESCHETTI trépano	196
BARR rectal	272	FARREL porta-algodón	89	FRANCIS aguja p.	
BODENHAMMER rectal	272	FAULKNER cureta cortante	228	cuerpos extranjeros	181
BOUCHERON auricular	198	FAURE pinza p. biopsia uterina	291	FRANKE aguja para tomar sangre	2
BREISKY vaginal	282	pinza para peritoneo	56	FRANKLIN SILVERM.	
BRUENINGS auricular,		FEHLAND pinza intestinal	263	aguja p. biopsia del hígado	91
neumático	198	pinza intestinal	263	FRAZIER cordótomo	170
CASPAR lumbar vertebral	82	FEILCHENFELD pinza p. espinas	38	ganchito (p. duramadre) agudo	68
COLLIN vaginal	276	FERGUSSON cuchara		separador	83
COTTLE nasal	213	p. cálculos biliares	257	tubo aspirador	171
CUSCO vaginal	276,277	pinza clamp de presión		tubo de punción	171
CZERNY rectal	272	progresiva	46	FREER bisturí p. mucosa	220
DOYEN vaginal	281	pinza para huesos	114	cincel p. tabique nasal	222
GRAVE vaginal	276	FERRIS SMITH KERRISON		cuchillo p. tabique nasal	220
GRUBER auricular	198	pinza sacabocado	174	elevador para tabique nasal	221
HARTMANN auricular	198	SMITH pinza de disección	36	gubia	224
HARTMANN HALLE nasal	212	SMITH pinza para laminectomía	173	FRENZEL abajalengua	230
JACKSON vaginal	281	FINOCHIETTO ALU infant		fresa	134
KALLMORGEN vaginal	280	separador costal	250	fresa, ALBEE	137
KILLIAN p. tabique	213	FINOCHIETTO ALU separador		BORCHARDT	137
KRISTELLER vcaginal	278-280	costal	250	fresa	137
LANDAU vaginal	282	FINOCHIETTO BURFORD ALU		fresa DOYEN	137
MATHIEU rectal	272	separador costal	251	fresa llana	137
PEDERSON vaginal	276	FINOCHIETTO BURFORD		fresa para corticalis	145
PRATT rectal	272	separador costal	251	TOTI	137
SEMM vaginal	277	FINOCHIETTO baby		FRIEDMAN pinza gubia	109
SIEGLE aural neumático	198	separador costal	250	separador para perineorrafia	282
SIMS vaginal	281	clamp bronquial	254	FRITSCH separador	73
SIMS rectal	272	porta aguja	94	FUCHS pinza capsular	193
THUDICHUM nasal	212	separador costal	250	GALLAHER lima para seno maxilar	226
TIECK HALLE nasal	213	FINSEN separador	76	ganchito	211
TOYNBEE auricular	198	FISCH descolador	211	ganchito, BARBARA	210
TRELAT vaginal	277	FISCHER pinza para iris	189	GILLIES fino	227

	Página		Página		Página
GRAEFE (iris)	68	pinza para iris	186,187	TIECK espéculo nasal	213
GUTHRIE	68	quistótomo	182	HALSEY porta aguja	92
JOSEPH para la mucosa	68	TITAN gancho para estrabismo	182	HALSTED mosquito pinzas	43
KILNER para la piel	306	GRAHAM gancho p. nervios	168	Hamburg cánula abotonada	196
McGEE	211	grapas de plata para		HANK dilatador uterino	285
McGEE	211	sutura intestinal	266	HARRINGTON pinza bronquial	254
WAGENER auricular	203	HEGENBARTH pinza para	104	separador	67
gancho, ARRUGA p. extracción	182	McKENZIE pinza para	166	HARTMANN abajalengua	230
BOSE traqueal	245	MICHEL	104	cateter auricular	202
BRAUN de decapitación	305	MICHEL pinzas para	104	COLLIN separador	65
CASPAR	81	RICHTER HEATH pinza para	104	diapasón	199
Clavo para huesos en forma de	146	SMITHWICK pinza para	166	espéculo auricular	198
CUSHING para nervios	168	SWEET pinza para poner	166	HALLE espéculo nasal	212
DAY auricular	203	WACHENFELDT	104	HOFFMANN pinza auricular	204
gancho de extracción	143	WACHENFELDT pinza para	104	pinza auricular	204
EMMET para fistula	296	GRAVE espéculos vaginales	276	pinza cortante nasal	217
gancho extractor de clavos	143	GRAY clamp para conducto biliar	54	pinza hemostática	42
GRAEFE TITAN		GREEN ARMYTAGE pinza		pinza para pólipos nasales	214
para estrabismo	182	clamp uterina	303	WULLSTEIN pinza auricular	204
GRAHAM para nervio	168	disecador corneal	182	HAUGH pinza auricular	206
GREEN muscular	182	gancho muscular	182	HEANEY pinza p. histerectomía	57
GROSS, y cureta	202	pinza de fijación	192	porta agujas	93
ITERSON traquel	245	SENN separador	69	separador	74
JACKSON traqueal doble	245	separador	72	HEATH RICHTER pinza p. grapas	104
gancho para estribos de extensión	140	GREVEN pinza p. doblar hilo	206	tijeras para ligaduras	28
PRATT cístico	274	GROSS cureta y gancho	202	HEBRA cucharilla p. chalazión	183
ROSE traqueal doble	246	MAIER pinza para pólipos	60	HEGAR dilatador uterino	183,284
SACHS p. nervios	168	GRUBER espéculo auricular	198	MAYO porta aguja	92
SMELLIE obstétrico	303	gubia	121	OLSEN porta aguja	95
SMITHWICK para nervios	168	gubia, ALEXANDER	121	HEGENBARTH pinza para grapas	104
STEVENS para cristalino	182	DIX, y aguja	185	HEIFETZ espátula cerebral	171
tijeras p. enterotomía	28	FREER	224	HEISS pinza hemostática	48
garrote, MAUNDER de madera	234	HAJEK forma V	224	HEISTER abreboca	231
PITHA de silicio	234	HIBBS	123	HENKE elevador p. amígdalas	235
GAUSS pinza para pericráneo	303	KILLIAN CLAUS en V	224	HENNIG separador p. yesos	108
GELLHORN pinza p. biopsia	292	LEXER	123	HERRICK pinza p. pedículo renal	56
GELPI separador perineal	86	PARTSCH	121	HESS GILL pinza para iris	188
Gemini pinzas de disección		SMITH PETERSEN	122	pinza capsular	193
y ligadura	49	STILLE	121	pinza para iris	188
GERALD pinzas de disección	37	WALTON p. cuerpos		HEYMANN KNIGHT pinza nasal	215
GERSTER barra de tracción	118	extranjeros	182	pinza cortante nasal	215
GERZOG martillo	125	WEST nasal	224	tijeras nasales	22
GIERTZ STILLE costótomo	249	guia, KIRSCHNER		HEYWOOD SMITH	
GIGLI mango p. sierra de hilo	169	telescópica, p. taladros	135	pinza para hemoroides	275
GILL ARRUGA pinza capsular	192	guia p. taladros filiformes	135	HIBBS cincel	123
cuchillo corneal	181	GUTHRIE ganchito doble	68	gubia	123
HESS pinza p. iris,	188	GUTMANN cuchara p.		osteótomo	123
GILLIES ganchito fino	227	secretiones	270	hilo p. huesos blando	141
pinza de disección	37	GUYON bujia dilatadora	271	HIRSCHMANN anoscopio	274
porta aguja c. tijeras	95	juego dilatador en estuche	270	histerómetros	289
GLOVER clamp cardiov. atrauma	41	mandril p. catéteres	270	HOESEL porta aguja	95
GLUCK costótomo	248	MAYO pinza p. pedículo	55	HOFER separador p. pilar	235
GOELET separador doble	65	pinza p. pedículo renal	55	HOHMANN elevador	
GOLDSTEIN blefarostato	179	GUYTON LUNDSGAARD		p. huesos	129,130
goniómetro, MOELTGEN	7	esclerótomo	181	mini elevador p. huesos	130
GOOD tijeras p. amígdalas	23	HABERER separador maleable	66	hoja de bisturí estéril	11
GOODELL dilatador uterino	285	HAGLUND STILLE separador		hojas de repuesto Credo	307
GOSSET separador abdominal	83	de yeso	108	hojas de afeitap. microcirugía	13
GRADLE pinza depilatoria	197	HAIGHT separador	252	HOKE cincel	123
GRAEFE blefarostato	178	HAJEK BALLENGER		HOLTH pinza p.	
cucharilla p. cataratas	183	elevador p. tabique	222	capsuloiridectomía	185
cuchillo p. catarata	179	CLAUS pinza p. seno maxilar	218	HOPKINS cuchillo p. yeso	108
escarificador	180	gubia forma V	224	JOHNS pinza hemost. y	
ganchito para iris	68	KOFLER pinza sacabocado	218	para cond. biliar	53
gancho p. estrabismo	182	HALLE bisturí p. duramadre	170	JOHNS serra-fina	42
pinza	35	cucharilla maleable	120	horquilla, BURCH fijadora	181
pinza de fijación	192	HARTMANN espéculo nasal	212	HORSLEY disecador de duramadre	170

	Página		Página		Página
STILLE pinza cortar huesos	114	JOHNSON porta aguja	94	sonda conductora	100
HOUSE cureta doble	211	JONES pinza p. campos	59	taladro filiforme	139
HUBER mango universal	240	JOSEPH (LEWIS) lima nasal	225	KLINKENBERGH LOTH	
HUDSON perforador a mano	134	bisturí nasal	220	tijeras torácicas	27
HUNTER pinza para espinas	38	bisturí p. plástica	220	KNAPP cucharilla p. cataratas	183
HURD disecador p. amígdalas	235	ganchito para mucosa	68	cuchillo para iris	180
disección p. amígdalas	235	lima para huesos	224	LUER pinza para tracoma	195
impactor /extractor para clavos	142	periostótomo	222	separador	182
impactor, KUENTSCHER	143	sierra nasal	227	KNIGHT HEYMANN pinza	
KUENTSCHER final	143	tijeras	21	cortante nasal	215
INGE separador vertebral	171	JUDD ALLIS pinza para intestino	259	KNOWLES tijeras p.	
instrumento LAFORCE		MASSON separador vesical	268	vendajes de dedos	30
p. cuerpos extraños	182	juego de diagnóstico	3	KOCHER espátula vesical	268
insuflador, POLITZER de aire	201	juego de instrumentos p. autopsia	124	pinza hemostática fina	45
IOWA pinza uterina	287	juego de manicura p. enfermeras	307	pinza intestinal	261
iris, BARRAQUER Colibri		juego de sierras, taladros y fresas	138	separador	72,73
tijeras para	32	juego de traqueotomía c. estuche	246	sonda para bocio	247
BISHOP HARMAN pinza para	190	juego para otoscopia	3	KOENIG aguja para suturas	103
Bonn pinza para	191	JUERS pinza p. doblar hilo	206	ROSER abreboca	231
CULLER espátula para	184	JURASZ pinza p. pólipos		sonda conductora	100
DEAN cuchillo para	180	laringeos	239	KOERTE separador	73
FISCHER pinza para	189	KABIERSKE lanza-polvo	200,201	KOGAN endospéculo	282
FOERSTER pinza para	188	KALLMORGEN espéculo vaginal	280	KONRICH tambor a filtro	
GRAEFE pinza para	186,187	KALT ARRUGA porta aguja	97	p. esterilización	311
KNAPP cuchillo para	180	pinza capsular	193	KRAUSE cierranudo auricular	203
NOYES tijeras para	32	porta aguja	97	cierranudo nasal	219
O'CONNOR gancho para	182	KANE clamp umbilical	303	punta de pinza laríngea	240
STEVENS pinza para	187	KEITH aguja de sutura	103	KRISTELLER espéculo	
tijeras para	21	KELLY pinza hemostática	45	vaginal	278-280
Tübingen pinza para	191	pinza p. pólipos uterinos	288	KRONECKER aguja de ligadura	98
WECKER espátula para	184	proctoscopia	274	KUENTSCHER clavo	
WECKER tijeras para	32	RANKIN pinza hemostática	45	intramedular	147,148
WIENER gancho para	182	separador	66,74	dilatador para el fémur	143
ISRAEL separador	73	tijeras ginecológicas	25	extractor de clavos	143
ITARD cateter auricular	202	TITAN pinza hemostática	45	impactor	143
ITERSON gancho traquel	245	KERN pinza para huesos	115	punzón medular	143
IVES FANSLER anoscopio	274	KERRISON pinza sacabocado	218	KUHNT legra p. la córnea	181
JACKSON CHEVALIER		KEVORKIAN cureta p.		LABORDE dilatador traqueal	245
pinza endoscópica	241	biopsia uterina	290	LAFORCE adenótomo	229
espéculo vaginal	281	EPPENDORFER pinza de		hoja de repuesto	229
gancho traqueal doble	245	biopsia uterina	296	instrumento p. cuerpos	
pinza porta tapones	239	Pacific pinza de biopsia		extranjeros	182
separador traqueal	245	uterina	294	LAHEY pinza bronquial	254
tubo traqueal	246	pinza para biopsia uterina	293	pinza p. conducto biliar	53
JACOBS pinza uterina	287	punta para pinza de biopsia	296	pinza para agarrar bocio	247
JAEGER placa p. párpados	179	TISCHLER pinza de biopsia		separador	70
querátomo	180	uterina	295	LAMBERT LOWMAN	
JAMESON gancho para		TISCHLER punta para pinza		clamp p. huesos	118
estrabismo	182	de biopsia uterina	294	pinza para chalazión	195
pinza p. estrabismo	189	TOWNSEND pinza para		LAMBOTTE FARABEUF pinza	
JAMISON porta agujas	93	biopsia uterina	294	p. huesos	115
JANSEN DOYEN abreboca	231	KEY elevador	128	mini osteótomo	122
MIDDLETON pinza cortante	219	KEYES juego de trefinas cutáneas	306	osteótomo	122
pinza nasal	214	KIELLAND forceps obstétricos	300	periostótomo	126
separador	76	LUIKART forceps obstétricos	301	pinza para huesos	115
ZAUFAL pinza gubia	111	KILLIAN canula de irrigación	219	lámpara frontal CLAR	4
JARCHO pinza uterina	286	CLAUS gubia en V	224	LANCASTER blefarostato	179
JATHO pinza faríngea cortante	228	elevador p. tabique nasal	222	LANDAU espéculo	282
JENNINGS abreboca	232	espéculo p. tabique nasal	213	LANE destornillador	144
jeringa para amígdalas	238	KILNER DOUGHTY abreboca	233	elevador p. doblar placas	144
jeringa, MENGHINI de aspiración	91	ganchito p. la piel	306	MURPHY elevador doble	129
REINER auricular	201	tijeras	21	pinza de disección	36
JEWETT clavo para huesos	150	KIRBY ARTHUR. pinza para iris	189	pinza clamp estomacal	265
JOBSON HORNE porta-algodón	89	KIRK martillo para huesos	125	pinza p. sostener placas	144
JOHNS HOPKINS pinza		KIRSCHNER estribo de extensión	140	pinza p. sostener tornillos	144
hemost./p. conducto biliar	53	perforador c. guía telescópica	135	pinza para campos	59
HOPKINS serra-fina	42	separador abdominal	85	pinza para huesos	115

	Página		Página		Página
LANG cureta y disecador		separador p. úvula	235	MASSON JUDD separador vesical	268
de saco lacrimal	184	separador para raíz de nervio	168	porta agujas	93
LANGE punta de pinza laríngea	240	LOVELACE pinza hemostática	46	MASTIN pinza muscular	247
LANGENBECK cuchillo		pinza pulmonar	254	MATHIEU espéculo rectal	272
de resección	15	LOWER pinza p. conducto biliar	53	pinza p. cuerpos extraños	269
dedal	234	LOWMAN clamp p. huesos	118	porta aguja	95
elevador	128	LAMBERT clamp p. huesos	118	separador doble, pareja	65
periestótomo	126	LUBET BARBON pinza		MATSON ALEXANDER	
pinza para huesos	114	para pólipos nasales	215	periestótomo	128
separador	71	LUC pinza cortante nasal	216	MAUNDER garrote de madera	234
sierra a dedo	133	LUCAE diapasón	200	MAY oftalmoscopio	2
laringoscopio, FOREGGER	8,9	martillo	125	MAYO (HARRINGTON) tijeras	19
McINTOSH	8,9	pinza auricular	203	BLAKE pinza para cálculos	
LAWRENCE pinza hemostática/		LUER KNAPP pinza para tracoma	195	bilíares	256
disección/ligaduras	52	pinza gubia	110	clip p. esterilizar	105
LEBSCHKE cincel para el esternón	124	STILLE pinza gubia	111	cuchara p. cálculos bilíares	257
legra, KUHNT p. la córnea	181	tubo traqueal	246	GUYON pinza p. pedículo	55
LEGUEU espátula vesical	268	LUIKART BILL tractor	302	HEGAR porta aguja	92
separador vesical	269	forceps obstétricos	301	ROBSON pinza intestinal	262
LEKSELL (STILLE) pinza gubia	112	KIELLAND fórceps obstétricos	301	sonda para cálculos renales	258
LEMPERT cucharilla	120	McLEAN fórceps obstétricos	301	STILLE tijeras	19
elevador	211	SIMPSON fórceps obstétricos	301	MAYO (HARRINGTON) tijeras	19
pinza gubia	110	LUNDGAARD esclerótomo	181	McCULLOUGH pinza para	
LERCHE pinza de disección	36	GUYTON esclerótomo	181	estrabismo	189
LERICHE pinza hemostática	48	LUNIATSCHEK obturador de gaza	235	McDONALD elevador doble	129
LESTER pinza p. fijación	192	LURZ pinza ureteral	258	McGEE ganchito	211
LEVINSON aguja p. cuerpos		MAGILL pinza p. introd. catéteres	8	McGEE pinza p. doblar hilo	206
extraños	181	MAISONNEUVE uretrótomo	269	McGUIRE tijeras corneales	32
LEWIN pinza para huesos	117	MALTZ (COTTLE) lima nasal	225	McINDOE pinza de disección	36
LEXER baby tijeras	20	mandril, GUYON p. catéteres	270	McINDOE tijeras para cartílago	27
cincel	123	mango con mandril Jacobs	136	McINTOSH laringoscopio	8,9
gubia	123	mango de bisturíes	10	McIVOR abreboza	233
tijeras	20	mango de pilas para laringoscopios	9	McKENTY elevador p. tabique	221
LICHTWITZ aguja de punción		mango para espejo laríngeo	241	McKENZIE perforador	134
del seno maxilar	219	HUBER universal	240	McKENZIE pinza p. poner grapas	166
trócar para el seno maxilar	90	mango p. desoblitador de vena	89	McLAUGHLIN placa ósea	149
lima, AUFRICHT nasal	224	manicura, juego de p. enfermeras	307	McLEAN fórceps obstétricos	301
FOMON nasal	225	mano de plomo	118	McLEAN LUIKART fórceps	
GALLAHER para seno maxilar	226	marcador, CASTROVIEJO	185	obstétricos	301
JOSEPH (LEWIS) nasal	225	CONNIN AMSLER	185	McLEAN TUCKER fórceps	
JOSEPH para huesos	224	MARSCHIK pinza p. amígdalas	237	obstétricos	301
MALTZ (COTTLE) nasal	225	MARTEL De, guía-sierra	169	McLEAN TUCKER LUIKART forceps	
lima para huesos	132	pinza p. el pericraneo	47	obstétricos	301
lima para uñas	307	WILLET pinza pericraneo	47	McPHERSON pinza p. ligadura	194
PUTTI p. huesos	132	martillo para huesos	125	MEAD martillo p. huesos	125
WIENER (AUFRICHT) nasal	225	martillo, BABINSKY	6	pinza gubia	109
WIENER para el seno maxilar	225	BERLINER	6	MEEKER pinza hemostática	52
LISTER (sinus) pinza p. medicación	62	BUCK	6	MELLINGER AXENFELD	
BURCH blefarostato	178	COLLIN	125	blefarostato	178
tijeras para vendajes	30	martillo con ranura		blefarostato	178
LISTON cuchillo p. amputación	15	p. clavos p. huesos	143	MENGHINI aguja p. la	
pinza cortante p. huesos	113	DEJERINE	6	punción del hígado	91
RUSKIN pinza cortante		GERZOG	125	jeringa de aspiración	91
para huesos	113	KIRK	125	trócar p. aguja de punción	91
STILLE pinza cortante		LUCAE	125	meniscótomo, BIRCHER	131
para huesos	113	MEAD	125	NEFF	131
LITTAUER pinza auricular	???	QUISLING intranasal	125	SMILLIE	131
pinza depilatoria	197	martillo relleno de plomo	125	MERCEDDES separador torácico	253
pinza para pólipos nasales	215	TAYLOR	6	METZENBAUM fino tijeras	20
tijeras para ligadura	28	TRAUBE	6	porta aguja	94
LITTLE separador	70	TROEMNER	6	tijeras	20,21
LLOYD impactor/extractor	144	WILLIGER	125	MEYERDING separador	70
LORENZ tijeras para vendajes	30	MARTIN histerómetro	289	MEYHOEFER cucharilla	
LORNA pinza para campos	59	pelvímetro	303	p. chalazión	183
LOUTE tensor cierra-hilo	141	pinza p. cartílagos	117	MICHEL espejo faríngeo	214
LOVE GRUENW. pinza para		St., pinza p. sutura	194	grapap	104
laminectomía	172	MARTINI cureta doble	120	pinzas para agrafes	104

	Página		Página		Página
micro pinza	39	trócar torácico	90	SEMB costal	127
micro tijeras	33	oftalmoscopios	2	periostótomo, COTTLE	222
MIDDELDORPF separador	72	OLDBERG pinza para		FARABEUF	126
MIDDLETON JANSEN		laminectomía	173	JOSEPH	222
pinza cortante	219	oliva auricular	201	LAMBOTTE	126
MIKULICZ pinza p. el peritoneo	56	oliva nasal	201	LANGENBECK	126
separador	74	OLIVCECRONA sierra de hilo	169	MATSON	128
MILLIGAN descolador		OLIVECRONA espátula cerebral	171	MATSON ALEXANDER	128
de duramadre	169	pinza gubia	110	OVERHOLT doble	128
MILLIN pinza capsular		TOENNIS pinza para		SEDILLOT	126
retropubiana	267	poner grapas	166	PERTHES perforador	138
pinza p. cápsula atraumática	267	OLLIER separador	72	PESTALOZZA cureta para aborto	304
pinza p. ligaduras	267	OLSEN HEGAR porta aguja	95	PETRI cubeta c. tapa	310
pinza p. el lóbulo anterior	267	osteótomos	121-123	PHANEUF pinza p. el peritoneo	56
separador para el		osteótomo, HIBBS	123	pick	211
cuello de la vejiga	269	LAMBOTTE mini	122	pick, BARBARA	210,211
miniclip, YASARGIL	176,177	STILLE	121	piedra, Arkansas de afilar	16
MIXTER baby pinza hemostática	52	OVERHOLT GEISSENDOERFER		PIERCE trócar para seno maxilar	90
O'SHAUGNESSY pinza	53	pinza hemostática	49	PIFFARD cureta p. lupus	306
pinza para cálculos biliares	256	periostótomo doble	128	PINARD fonendoscopio	5
pinza hemostática	53	PARHAM cinta para huesos	118	pinza, ADLERKREUTZ	36
pinza hemostática y bronquial	52	tensor de cintas	118	ADSON baby hemostática	48
pinza p. el conducto biliar	54	PARK blefarostato	179	ADSON BROWN	35
MOELTGEN goniómetro	7	PARKER bisturí	14	ADSON de disección	35
MOLLISON separador	79	separador doble pareja	64	ADSON pituitaria	170
MOORE cuchara p. cálculos		PARTSCH cincel	121	ALEXANDER p. biopsia	292
biliares	256	gubia	121	ALLIS ADAIR para intestinos	259
perforador a mano	134	PASSOW cincel hemostático	211	ALLIS baby para intestinos	259
STAUDE pinza uterina	286	PATON disecador corneal	181	ALLIS para intestinos	259
MOORFIELD pinza para sutura	194	PAUFIQUE cuchillo p.		ARRUGA capsular	193
motor a mano eléctrico	136	queratoplástica	181	ASCH para enderezar	
MOYNIHAN pinza clamp	54	pinza p. ligaduras	194	tabique nasal	228
pinza para campos	59	PAYR baby pinza clamp		pinzas auriculares	204-209
sonda para cálculos biliares	257	intestinal	266	pinza AYER para chalazión	195
MUCK cuchillo p. periostio	211	pinza clamp intestinal	266	BABCOCK p. tejidos e intestino	259
MUELLER blefarostato	179	SCHMIEDEN sonda conductora	100	BACKHAUS para campos	59
MURDOCK blefarostato	178	sonda conductora	100	BAGGISH de biopsia uterina	295
MURPHY LANE elevador doble	129	PEAN pinza hemostática	47	BAINBRIDGE hemostática	53
MUSEUX pinza uterina	287	pinza hemostática fina	45	BALLENGER p. coger	
MYLES pinza cortante nasal	217	ROCHESTER pinza hemostática	45	amígdalas	237
NABATOFF set de desobliteración		PEDERSON espéculo vaginal	276	BARRAQUER para	
p. várices	88	PEET pinza para espinas	38	la cámara anterior	191
NAEGELE fórceps obstétricos	300	PELKMANN pinza para pólipos	62	BARRAQUER Colibri para iris	189
NAGER separador paladar	235	pelvimetro, COLLIN	303	BARRAQUER de fijación	192
navaja	16	COLLYER	303	BARRAQUER depilatoria	197
NEFF meniscótomo	131	MARTIN	303	BARRAQUER KATZIN para iris	189
NEGUS pinza para amígdalas	236	PENFIELD disecador	170	BARRETT uterina	286
NEIVERT COTTLE separador	227	PENNINGTON pinza hemostática	46	BEER depilatoria	197
porta aguja	92	PERCY retractor p. amputación	133	BENGOLEA hemostática	48
NELSON aguja para ligaduras	98	perfora-cráneo, SMELLIE	305	BERKE muscular	191
pinza	37	perforador a mano	138	BEST intestinal	263
trócar torácico	90	perforador para uñas	133	BEYER sacabocado para	
NORTHBENT (SPENCER)		perforador BUNNELL a mano	135	huesos	218
tijeras p. ligaduras	28	perforador con guía telescópica	135	pinza para biopsia	
NOTO pinza p. pólipos uterinos	288	perforador con mandril Jacobs	136	y coagulación	243
NOVAK cureta aspiradora uterina	290	CRUTCHFIELD inicial	167	pinza para biopsia flexible	242
NOYES pinza para pólipos		CUSHING aplatado	134	pinza bipolar de coagulación	
nasales	215	HUDSON	134	por AF	316-318
tijeras para iris	32	McKENZIE	134	BIRCHER GANSKE p. huesos	117
O'CONNOR gancho p. iris	182	MOORE a mano	134	BISHOP HARMAN para iris	190
O'SULLIVAN O'CONNOR		perforador p. clavos		BLAKE para cálculos	
separador abdominal	83	intramedulares	142	biliares	256
obturador, LUNIATSCHEK		PERTHES	138	BLOHMKE p. coger amígdalas	237
de gaza	235	RALK	135	BLUMENTHAL gubia	109
OCHSNER ROCHESTER		STILLE a mano	134	BOEHLER cortante p. huesos	113
pinza hemostática	45	STILLE SHERMAN	134	BOEHLER gubia	111
sonda para cálculos biliares	256	periostótomo, DOYEN costal	127	Bonn para iris	190,191



	Página		Página		Página
BOZEMANN DOUGLAS		ELSCHNIG capsular	193	JATHO faríngea cortante	228
p. pólipos	63	ELSCHNIG para fijación	192	JOHNS HOPKINS hemost.	
BOZEMANN para pólipos	63	EPPENDORFER para		y p. conducto biliar	53
BRAUN uterina	286	biopsia uterina	295,296	JUDD ALLIS para intestinos	259
BROWN de disección	35	FARABEU F LAMBOTTE		JUERS p. doblar hilo	206
BRUENINGS cortante nasal	215	p. huesos	115	JURASZ p. pólipos laríngeos	239
BRUNNER intestinal	263	FARABEU F para huesos	114	KALT capsular	193
BRYANT para medicación	62	FAURE p. biopsia uterina	291	KELLY hemostática	45
BURKE sacabocados para		FAURE p. peritoneo	56	KELLY para pólipos uterinos	288
biopsia uterina	294	FEHLAND intestinal	263	KELLY RANKIN hemostática	45
CASTROVIEJO capsular	193	FERGUSSON para huesos	114	KELLY TITAN hemostática	45
CASTROVIEJO p. fijación	192	FERRIS SMITH KERRISON		KERN para huesos	115
CASTROVIEJO p. sutura	194	p. discos intervertebr	174	KERRISON	218
CHAPUT hemostática	47	FERRIS SMITH de disección	36	KEVORKIAN Pacific p.	
CHEATLE p. instrumentos	105	FERRIS SMITH para		biopsia uterina	294
CHERON para pólipos	62	laminectomía	173	KEVORKIAN para biopsia	
CHEVALIER JACKSON		pinza flexible	242-244	uterina	293
endoscópica	241	FOERSTER p. esponjas	61	KIRBY ARTHUR para iris	189
CHILDE p. borde de herida	104	FRAENKEL p. pólipos		KNAPP LUER para tracoma	195
pinza cierratubo	58	laríngeos	239	KNIGHT cortante nasal	215
CITELLI sacabocado para		FUCHS capsular	193	KOCHER hemostática fina	45
huesos	218	GAUSS para pericraneos	303	KOCHER intestinal	261
COLCLOUGH para discos		GELLHORN p. biopsia uterina	292	LAHEY bronquial	254
intervertebrales	175	Gemini hemostática y de		LAHEY p. conducto biliar	53
COLLIN DUVAL	36	disección	49	LAHEY para agarrar bocio	247
COLLIN hemostática	47	GERALD de disección	37	LAMBERT para chalazión	195
COLLIN histerólabo	288	GILL ARRUGA capsular	192	LAMBOTTE para huesos	115
COLLIN para pólipos	62	GILL HESS para iris	188	LANE de disección	36
COLLIN tira-lengua	231	GILLIES	37	LANE p. sostener placas	144
COLVER p. coger amígdalas	236	GRADLE depilatoria	197	LANE p. sostener tornillos	144
COOLEY Atrauma	40	GRAEFE	35	LANE para huesos	115
pinza corta-hilo	142	GRAEFE para fijación	192	LANGENBECK para huesos	114
COS p. doblar hilo	206	GREVEN p. doblar hilo	206	LAWRENCE hemostática	
COTTLE KAZANJIAN para		GROSS MAIER para pólipos	60	y de disección	52
corta huesos	113	GUYON p. pedículo renal	55	LERCHE de disección	36
CRILE hemostática	45	HAJEK CLAUS p. seno maxilar	218	LERICHE hemostática	48
CRILE RANKIN hemostática	45	HAJEK KOFLER	218	LESTER de fijación	192
CRILE TITAN hemostática	45	HALSTED micro mosquito	43	LEWIN para huesos	117
pinza para cuerpos extraños		HALSTED mosquito	43	LISTER (sinus) p. medicaciones	62
p. gastroscopía	244	HALSTED TITAN mosquito	43	LISTON cortante p. huesos	113
CUSHING de disección	35	HARRINGTON bronquial	254	LITTAUER auricular	204
CUSHING para laminectomía	172	HARTMANN auricular	204	LITTAUER depilatoria	197
pinza cuticular	307	HARTMANN cortante nasal	217	LITTAUER para pólipos nasales	215
DANDY hemostática	46	HARTMANN hemostática	42	LOVE GRUENWALD	
DARTIGUES histerólabo	288	HARTMANN HOFFMANN		para laminectomía	172
DAVIS p. coger jeringas	105	auricular	204	LOVELACE hemostática	46
pinzas de disección	34-37	HARTMANN para pólipos		LOVELACE pulmonar	254
pinza de relojero	38	nasales	214	LOWER p. conducto biliar	53
DEBAKEY Atrauma	40	HARTMANN WULLSTEIN		LUBET BARBON para	
DeMARTEL WOLFSON		auricular	204	pólipos nasales	215
p. anastomosis	264	HAUGH auricular	206	LUC cortante nasal	216
DeMARTEL WOLFSON		HEANEY p. histerectomía	57	LUCAE auricular	203
p. cerrar pinzas	264	HEISS hemostática	48	LURZ ureteral	258
pinza depilatoria	197	HERRICK p. pedículo renal	56	MARSCHIK p. amígdalas	237
DESJARDINS para		HESS capsular	193	MARTEL p. el pericraneos	47
cálculos biliares	256	HESS p. iris	188	MARTIN p. cartílagos	117
DESMARRES de chalazión	195	HEYMANN cortante nasal	215	MASTIN muscular	247
DeVILBISS craneana	169	HEYMANN KNIGHT nasal	215	MATHIEU p. cuerpos	
DIETER p. cabeza del martillo	206	HEYWOOD SMITH		extranjeros	269
DINGMANN para huesos	117	para hemorroides	275	MAYO BLAKE para cálculos	
DOUGLAS depilatoria	197	HOLTH p. capsuloiridectom	185	biliares	256
DOYEN baby intestinal	260	IOWA uterina	287	MAYO GUYON p. pedículo	55
DOYEN intestinal	260	JACKSON porta tapones	239	MAYO ROBSON intestinal	262
DOYEN para pólipos uterinos	288	JACOBS uterina	287	MAYO ROBSON intestinal	
DUPLAY uterina	286	JAMESON para estrabismo	189	Atrauma	262
DUVAL	36	JANSEN nasal	214	McCULLOUGH para	
DUVAL p. intestino y tejido	260	JARCHO uterina	286	estrabismo	189

	Página		Página		Página
McCULLOUGH para		RUMEL torácica	50	pinza universal para	
estrabismo	189	RUSKIN LISTON cortante para		sostener instrumentos	105
McGEE para doblar hilo	206	huesos	113	pinza USA de disección	34
McINDOE de disección	36	SAENGER p. aborto y placenta	304	van DOREN p. biopsia uterina	292
McPHERSON p. ligadura	194	SAROT bronquial	255	VERBRUGGE para huesos	116
McPHERSON TITAN p. ligadura	194	SATINSKY para anastomosis	255	WAGNER para laminectomía	173
MEEKER hemostática		SAWTELL p. amígdalas	236	WALSHAM para enderezar	
y de disección	52	SCHNIDT p. amígdalas	236	tabique nasal	228
micro	39	SCHOENBURG p. intestinos	260	WANGENSTEEN	37
MIDDLETON JANSEN cortante	219	SCHROEDER uterina	286,287	WEIL BLAKESLEY	216
MIKULICZ p. el peritoneo	56	SCHUBERT p. biopsia uterina	291	WERTHEIM CULLEN	
MILLIN capsular retropubiana	267	SCHUMACHER p. biopsia		p. histerectomía	57
MILLIN p. cápsula Atrauma	267	uterina	293	WHITE p. coger amígdalas	236
MILLIN p. ligaduras	267	SCHWEIGGER capsular	193	WILDE TROELTSCH auricular	203
MILLIN p. lóbulo anterior	267	SEMB bronquial	255	WILLET MARTEL de pericraneos	47
MIXTER baby hemostática	52	SEMB cortante para huesos	114	WILLIAMS p. intestinos	260
MIXTER para cálculos biliares	256	SEMB para huesos	114	WINTER p. aborto y placenta	304
MIXTER hemostática		SEMKEN de disección	37	WITTNER p. biopsia uterina	293
y bronquial	52,53	SINGLEY	37	YEOMAN p. biopsia rectal	275
MIXTER O'SHAUGNESSY	53	SKENE uterina	286	YOUNG p. sacar próstata	267
MIXTER p. conducto biliar	54	SNELLEN de entropión	195	YOUNG tira-lengua	231
pinza modelo ruso	36	SOMER histerólabo	288	ZENKER de disección	
MOORFIELD para sutura	194	SPENCER WELLS hemostática	46	y porta-ligaduras	51
MUSEUX uterina	287	SPURLING para		PIPER fórceps obstétricos	302
MYLES cortante nasal	217	laminectomía	172	PITHA garrote de silicio	234
NEGUS para amígdalas	236	St. MARTIN p. sutura	194	Placas de osteosíntesis	151,156-164
NELSON de disección	37	STAUDE MOORE uterina	286	placa acodada	160
NOTO para pólipos uterinos	288	STILLE de disección	34	placa condilar	159
NOYES para pólipos nasales	215	STILLE HORSLEY		JAEGER p. párpados	179
OLDBERG para laminectomía	173	cortante para huesos	114	McLAUGHLIN para huesos	149
OLIVECRONA TOENNIS		STILLE LISTON		placa para extender la piel	15
para grapas	166	cortante para huesos	113	SHERMAN para huesos	164
pinzas para campos	59	STILLE p. pedículo renal	55	SMITH PETERSEN para huesos	149
pinza p. cortar y doblar alambre	141	STOCKMANN p. el pénis	270	PLESTER cucharilla lobar	210
pinza p. esterilización	105	STONE para cerrar pinzas	263	separador	76
pinza p. poner clips de aneurisma	177	STONE WATT intestinal	263	POLITZER aguja de paracentesis	202
pinza p. secuestros	117	STRAUSS p. el pénis	270	insuflador de aire	201
pinza para espinas	38	STRUJEMPEL auricular	204	porta aguja, ADSON	94
pinza para huesos	116,117	STRUYCKEN nasal	217	ARRUGA	96
pinza para uñas	307	TEALE uterina	287	BARRAQUER	97
PAUFIQUE para ligadura	194	TERSON capsular	193	BAUMGARTNER	92
PAUFIQUE TITAN para ligadura	194	THOMS ALLIS para intestinos	259	BOYNTON	96
PEAN hemostática	47	THOMS GAYLOR p. biopsia		BOZEMANN	93
PEAN hemostática fina	45	uterina	292	CASTROVIEJO	97
PELKMANN para pólipos	62	TILLEY auricular	204	COLLIER	92
PENNINGTON hemostática	46	TISCHLER KEVORKIAN		CRILE	94
PHANEUF p. el peritoneo	56	para biopsia uterina	295	CRILE MURRAY	92
pinza picos planos	141	TISCHLER MORGAN		CRILE WOOD	92
POTTS SMITH de disección	34	p. biopsia uterina	293	DERF	92
PRATT hemostática	47	TIVNEN p. coger amígdalas	237	FINOCHIETTO	94
PRATT uterina	287	TOENNIS hemostática	50	GILLIES, con tijeras	95
PRICE THOMAS bronquial	254	TOWNSEND para biopsia		HALSEY	92
PRINCE muscular	191	uterina	294	HOESEL	95
PROVIDENCE HOSPITAL		TOWNSEND KEVORKIAN		JOHNSON	94
hemostática	44	para biopsia uterina	294	KALT	97
RAMPLEY para esponjas	61	TOWNSEND mini para		KALT ARRUGA	97
RANDALL para cálculos		biopsia uterina	295	MATHIEU	95
renales	258	TOWNSEND TISCHLER MORGAN		MAYO HEGAR	92
RANEY hemostática		para biopsia uterina	294	METZENBAUM	92
p. cuero cabelludo	167	TROELTSCH nasal	214	NEIVERT	92
RANEY p. poner y quitar	167	TROUTMAN Colibri para iris	189	OLSEN HEGAR	95
ROBERTS hemostática	50	TROUTMAN para rectus	191	SAROT	94
ROCHESTER CARMALT		Tübingen para ligaduras	194	STEVENS	96
hemostática	46	TUFFIER hemostática	47	STRATTE	94
ROCHESTER PEAN hemostática	45	TURREL biopsia rectal	275	TOENNIS	94
ROWE para mandíbulas	234	TYDING p. coger amígdalas	237	WANGENSTEEN	93
RUBIN p. magullar tabique	217	ULRICH para tapones	60	YOUNG, boomerang	99

	Página		Página		Página
POOLE tubo de aspiración	8	riñonera	309	SCHNIDT pinza p. amígdalas	236
porta-algodón	89	ROBERTS pinza hemostática	50	SCHOENBORN separador	
porta-algodón	89	ROCHESTER CARMALT		p. tiroide	247
FARREL	89	pinza hemostática	46	SCHOENBURG pinza p. intestinos	260
JOBSON HORNE	89	OCHSNER pinza hemostática	45	SCHROEDER pinza uterina	286,287
TOBOLD laríngeo	89	PEAN pinza hemostática	45	SCHUBERT pinza p. biopsia	
UCKERMANN	89	ROEDER pinza para campos	59	uterina	291
porta-grapas para		ROGER elevador tabique	221	SCHUKNECHT cuchillo circular	210
sutura cerebral	166	ROGGE pinza p. esterilizar	105	cuchillo forma de hoz	210
POTTS DE MARTEL		ROLLET cincel para		SCHULTZE salpingógrafo	297
tijeras vasculares	23	extirpación	182	SCHUMACHER pinza p. biopsia	
SMITH tijeras vasculares	24	separador	182	uterina	293
SMITH pinza de disección	34	rompecráneo, VIRCHOW	124	punta de pinza	240
PRATT espéculo rectal	272	ROSE gancho traqueal	246	tijeras p. cordón umbilical	26
gancho cístico	274	ROSEN aguja	210,211	SCHWEIGGER pinza capsular	193
pinza hemostática	47	cuchillo circular	210	secuestros, pinza para	117
pinza uterina	287	ROSENBERG punta de pinza		VAN BUREN pinza para	117
PRICE THOMAS pinza bronquial	254	laríngea	240	SEDILLOT periostótomo	126
PRINCE pinza muscular	191	ROSER KOENIG abreboca	231	SEEMANN SEIFFERT abreboca	232
tijeras p. amígdalas	23	ROUX separadores	64	SEGOND bisturí p. fibroma	296
proctoscopio, KELLY	274	ROWE pinzas para mandíbulas	234	SEIFERRT punta de pinza	
protector, ARRUGA	184	RUBIN pinza p. magullar tabique	217	laríngea	240
protector de tejido	145	RUMEL pinza torácica	50	SELLHEIM separador p.	
PROVIDENCE HOSPITAL		RUSKIN LISTON pinza		salida de cabeza	305
pinza hemostática	44	cortante para huesos	113	SEMB periostótomo de costillas	127
pudendus, aguja p. anestesia	91	pinza gubia	111	pinza bronquial	255
punzón, KUENTSCHER medular	143	STILLE pinza gubia	112	pinza cortante para huesos	114
PUTTI lima p. huesos doble	132	RYDEL SEIFFER diapasón	200	pinza gubia	113
querátomo, BERENS	180	RYDER porta aguja	93	pinza para huesos	114
CASTROVIEJO	180	SAALFELD saca comedones	306	SEMKEN pinza de disección	37
JAEGER	180	SACHS descolador de duramadre	169	SEMM espéculo ginecológico	277
QUINBY tijeras para encías	29	gancho p. nervios	168	SENN GREEN separador	69
QUIRE elevador para		SAENGER pinza p.		separador	66
cuerpos extranjeros	204	aborto y placenta	304	separador	72
QUISLING martillo intranasal	125	salpingógrafo, SCHULTZE	297	separador (traqueal)	68
quistótomo, BECKER maleable	182	SANVENERO tijeras	21	separador, ADSON	77
GRAEFE	182	SAROT pinza bronquial	255	ADSON baby	77
RADOLF pinza p. arrancar uñas	133	pinza clamp bronquial	51	ADSON para duramadre	168
RALK perforador a mano	135	porta aguja	94	separador flexible a resorte	68
RAMPLEY pinza para esponjas	61	SATINSKY pinza para		ALM	76
RANDALL cureta aspiradora		anastomosis	255	AUFRICHT nasal	227
p. biopsia uterina	290	tijeras torácicas	27	BALFOUR abdominal	84
pinza para cálculos		SATO cuchillo corneal	181	BALFOUR baby abdominal	84
renales	258	SATTERLEE sierra para		BECKMANN	78
RANEY pinza hemostática		amputación	133	BECKMANN EATON	78
p.cuero cabelludo	167	SAUERBRUCH caja p. agujas	308	BLOUNT para rodilla	131
pinza p. poner y quitar		costótomo	249	BOSE traqueal	245
pinzas hemostáticas	167	FREY costótomo	249	BUNNELL para tendones	132
raquiótomo	124	pinza gubia	112	CASPAR	80,82
RECAMIER curetas uterinas	299	separador	75	CASPAR para laminectomía	81
rectoscopio, STRAUSS	273	SAWTELL pinza p. amígdalas	236	CASPAR p. tejido blando	80
reflector de repuesto suelto	4	SCAGLIETTI pinza gubia	112	CASTAÑEDA ALU para costillas	252
reglas	7	SCHAEDEL pinza para campos	59	CLOWARD	79
REICHERT depresor p. epiglotis	239	SCHAMBERG saca		CLOWARD vertebral	171
REINER cuchillo p. yeso	108	comedones doble	306	COLLIN abdominal	86
jeringa auricular	201	SCHEDE cucharilla cortante	119	COLLIN HARTMANN	65
relojero, pinza de	38	SCHEIE cánula oftálmica	196	COTTLE	227
REVERDIN aguja de sutura	99	cuchillo p. goniotomía	181	COTTLE NEIVERT	227
separador abdominal	66	SCHENNMANN punta de pinza		CRILE	65
REYNOLDS tijeras	21	laríngea	240	CUSHING	69
RIBBON separador	66	SCHIMMELBUSCH tambor de		DANDY p. nervios	168
RICHARDSON EASTMAN		esterilización	311	DARLING	79
separador	66	SCHINK dermatótomos	15	DEAVER	67
separador	66	SCHIOETZ tonómetro	197	DESMARRES	
RICHTER HEATH		SCHMIEDEN PAYR		(también de párpados)	69
pinza p. agrafes	104	sonda conductora	100	separador doble	87
RIGBY separador rectal,vaginal	86	TAYLOR tijeras p. duramadre	27		

	Página		Página		Página
DOYEN abdominal	74	ROUX	64	HEYWOOD pinza	
FARABEUF doble pareja	64	SAUERBRUCH	75	para hemorroides	275
FINOCHIETTO ALU de costillas	250	SCHOENBORN p. tiroide	247	PETERSEN cincel	122
FINOCHHIETTO ALU		SELLHEIM p. la salida		PETERSEN clavo para huesos	149
infant de costillas	250	de la cabeza	305	PETERSEN gubia	122
FINOCHIETTO BURFORD		SENN	66	PETERSEN placa para huesos	149
de costillas	251	SENN GREEN	69	POTTS pinza de disección	34
FINOCHIETTO BURFORD ALU		SIMON abdominal	74	POTTS tijeras vasculares	24
de costillas	251	SMITH BUIE rectal	273	US Army tijeras p. gaza	29
FINOCHIETTO de costillas	250	STERNBERG de labios	230	SMITHWICK gancho para nervios	168
FINOCHIETTO baby de costillas	250	TAYLOR espinal	131	pinza p. poner grapas	166
FINSEN	76	THOMSON WALKER vesical	268	SNELLEN asa	184
FOMON p. alas	227	TUFFIER	252	pinza para entropión	195
FOMON p. coanas	227	US Army doble pareja	65	SOMER pinza histerólabo	288
FRAZIER	83	VOLKMANN	69,70	sonda, BAKES p. cálculos biliares	257
FRIEDMAN de perieorrafia	282	WEITLANER	76	BOWMAN lacrimal	186
FRITSCH	73	WEITLANER WULLSTEIN	76	BRUNNER conductora	100
GELPI perineal	86	YOUNG prostático	267	DESJARDINS para	
GOLET doble	65	serra-fina, DIEFFENBACH	42	cálculos biliares	257
GOSSET abdominal	83	JOHNS HOPKINS	42	KIRSCHNER conductora	100
GREEN	72	SEXTON cuchillo auricular	202	KOCHER para bocio	247
HABERER maleable	66	SHEA tijeras microquirúrgicas	205	KOENIG conductora	100
HAGLUND STILLE para yeso	108	SHERMAN placa para huesos	164	MAYO para cálculos renales	258
HAIGHT	252	STILLE perforador a mano	134	MOYNIHAN para cálculos	
HARRINGTON	67	tornillo para huesos	164	biliares	257
HEANEY	74	SIEBOLD tijeras ginecológicas	25	NABATOFF para várices	88
HOFER p. pilar	235	SIEGLE espéculo		OCHSNER para	
INGE vertebral	171	auricular neumático	198	cálculos biliares	256
ISRAEL	73	sierra, CHARRIERE p. amputación	133	PAYR conductora	100
JACKSON traqueal	245	sierras circulares	138	SCHMIEDEN conductora	100
JANSEN	76	sierra eléctrica oscilante p. yeso	107	SCHMIEDEN PAYR conductora	100
JUDD MASSON vesical	268	ENGEL p. vendajes enyesados	106	STACKE auricular	88
KELLY	66,74	GIGLI mango sólo	169	tijeras p. enterotomía	28
KIRSCHNER abdominal	85	hoja de repuesto, p. amputación	133	SPENCER tijeras para ligaduras	28
KNAPP	182	JOSEPH nasal	227	WELLS pinza hemostática	46
KOCHER	72,73	LANGENBECK a dedo	133	SPRATT cucharilla cortante	119
KOERTE	73	OLIVCECRONA hilo	169	SPURLING pinza para	
separador de labios y mejillas	231	sierra para anillos	133	laminectomía	172
LAHEY	70	SATTERLEE p. amputación	133	St. MARTIN pinza p. sutura	194
LANGENBECK	71	SILVER cincel p. plástica	224	STACKE sonda auricular plata	88
LEGUEU vesical	269	SIMCOE cánula para sutura	196	STAUDE MOORE pinza uterina	286
LITTLE	70	SIMON cuchara uterina	297	StCLAIR THOMSON cuchillo	
LOVE p. uvula	235	cucharilla cortante	120	para vegetaciones	229
LOVE para raíz de nervio	168	separador abdominal	74	STEINMANN clavo para huesos	139
MATHIEU doble pareja	65	SIMPSON BRAUN		STERNBERG separador de labios	230
MERCEDES torácico	253	fórceps obstétricos	300	STEVENS gancho para cristalino	182
MEYERDING	70	fórceps obstétricos	300	pinza p. iris	187
MIDDELDORPF	72	LUIKART fórceps obstétricos	301	porta aguja	96
MIKULICZ	74	SIMS cureta uterina	299	tijeras para tenotomía	22
MILLIN para el cuello		depresor uterino	289	STEVENSON blefarostato	179
de la vejiga	269	dilatador uterino	285	STIEGLITZ pinza para espinas	38
MOLLISON	79	espéculos vaginales	281	STILLE cincel	121
separador muscular juego	87	espéculo rectal	272	cizalla p. yesos	106
NAGER paladar	235	histerómetro	289	costótomo	248
O'SULLIVAN O'CONNOR		tijeras para el útero	25	GIERTZ costótomo	249
abdominal	83	SINGLEY pinza	37	gubia	121
OLLIER	72	SKENE pinza uterina	286	HAGLUND separador de yeso	108
separador p. yeso	108	SLUDER BALLENGER		HORSLEY pinza cortante	
PARKER doble pareja	64	amigdalótomo	238	para huesos	114
PLESTER	76	SMELLIE gancho obstétrico	303	LISTON pinza cortante	
REVERDIN abdominal	66	perfora-cráneo	305	para huesos	113
RIBBON	66	SMILLIE meniscótomo	131	LUER pinza gubia	111
RICHARDSON	66	SMITH blefarostato	178	MAYO tijeras	19
RICHARDSON EASTMAN	66	BUIE separador rectal	273	osteótomo	121
RIGBY rectal,vaginal	86	FERRIS pinza de disección	36	perforador a mano	134
ROLLET	182	FERRIS pinza		pinza de disección	34
separador flexible a resorte	68	para laminectomía	173	pinza p. pedículo renal	55

	Página		Página		Página
RUSKIN pinza gubia	112	DUBOIS ginecológicas	25	WESTCOTT p. tendones	32
SHERMAN perforador a mano	134	FOMON nasales	22	WULLSTEIN microquirúrgicas	
STOCKMANN pinza p. el p.énis	270	GILLIES porta aguja con tijeras	95	de oídos	207
STONE pinza para cerrar pinzas	263	GOOD p. amígdalas	23	tijeras quirúrgicas	19-33
WATT manguito de cierre	263	HEATH para ligaduras	28	TILLEY pinza auricular	204
WATT pinza intestinal	263	HEYMANN nasales	22	tirabuzón, DOYEN p. fibroma	296
STRATTE porta aguja	94	JOSEPH	21	TISCHLER KEVORKIAN	
STRAUSS pinza p. el p.énis	270	KELLY ginecológicas	25	pinza p.biopsia uterina	295
rectoscopio	273	KILNER	21	KEVORKIAN punta p.pinza	
STRUEMPEL pinza auricular	204	KLINKENBERGH LOTH		de biops.uterina	294
STRULLY tijeras neuroquirúrgicas	26	torácicas	27	MORGAN pinza de biopsia	
STRUYCKEN pinza nasal	217	KNOWLES p. vendajes		uterina	293
SWEET pinza para poner grapas	166	de los dedos	30	MORGAN punta p. pinza de	
TABB cuchillo en forma de hoz	210	LEXER	20	biopsia uterina	294,296
taladros	134,137	LISTER para vendajes	30	TOWNSEND MORGAN pinza	
taladro KIRSCHNER filiforme	139	LITTAUER para ligadura	28	de biopsia uterina	294
tallo-guía	143	MAYO (HARRINGTON)	19	TIVNEN pinza p. coger amígdalas	237
tambor, KONRICH,		MAYO	19	tjeras para enucleación	22
de esterilización, c.filtro	311	MAYO NOBLE	19	tjeras para estrabismo	22
SCHIMMELBUSCH,		MAYO STILLE	19	TOBOLD abajalengua	230
de esterilización	311	McGUIRE corneales	32	porta-algodón laríngeo	89
TARNIER cranioclasto	305	McINDOE para cartílago	27	TOENNIS ADSON tijeras	
fórceps	302	METZENBAUM	20,21	neuroquirúrgicas	26
tarro	310	microquirúrgicas	33	descolador de duramadre	169
TAYLOR martillo	6	tijeras microquirúrgicas		OLIVECRONA pinza	
SCHMIEDEN tijeras		de oídos	205,207	para grapas	166
de duramadre	27	NORTHBENT (SPENCER)		pinza hemostática	50
separador espinal	131	para ligaduras	28	porta aguja	94
TEALE pinza uterina	287	tijeras p. cordón umbilical	26	tonómetro, SCHIOETZ	197
tensiómetros	1	tijeras p. enterotomía	28	TOOK cuchillo corneal	181
tensor, LOUTE cierra-hilo	141	tijeras p. parametrio	24	tornillo de corticalis	153-155
tensor p. perforadores		tijeras p. preparación de nervios	26	tornillo de compresión	151
filiformes	140	tijeras p. preparación	26	tornillo de esponjosa	152-156
PARHAM de cintas para huesos	118	tijeras p. uñas	307	tornillo de fémur dinámico	151
terraja p. tornillo acanalado	145	tijeras para encías	29	tornillo maleolar	154
TERSON pinza capsular	193	tijeras para incisiones	19	tornillo mini	153
THOMAS PRICE pinza bronquial	254	tijeras para iris	21	tornillo de perforación	
THOMS ALLIS pinza para		tijeras para vendajes universales	30	longitudinal	152
intestinos	259	tijeras para yesos	30	torniquete „clip“	2
GAYLOR pinza p. biopsia		POTTS DE MARTEL vasculares	23	TOTI fresa	137
uterina	292	POTTS SMITH vasculares	24	TOWNSEND KEVORKIAN	
THOMSON StCLAIR cuchillo	229	PRINCE p. amígdalas	23	pinza de biopsia uterina	294,295
WALKER separador vesical	268	REYNOLDS	21	TISCHLER MORGAN pinza	
THOREK tijeras pulmonares		SANVENERO	21	de biopsia uterina	294
(torácicas)	27	SATINSKY torácicas	27	TOYNBEE espéculo auricular	198
THUDICHUM espéculo nasal	212	SCHMIEDEN TAYLOR		traqueotomía, juego de en estuche	
TIECK HALLE espéculo nasal	213	de duramadre	27	TRAUBE martillo	6
tijeras, AEBLI corneales	22	SCHUMACHER p. cordón		trefinas, KEYES cutáneas	306
BEEBEE	29	umbilical	26	TRELAT espéculo vaginal	277
BELLUCCI microquirúrgicas	205	SHEA microquirúrgicas		trépano, CASTROVIEJO	196
BEUSE dentadas	23	de los oídos	205	FRANCESCHETTI	
BOETTCHEP p. amígdalas	23	SIEBOLD ginecológicas	25	de queratomía	196
BRAUN STADLER p. episiotomía	26	SIMS para el útero	25	KEYES	306
BRUNS para vendajes	30	SMITH US Army p. gaza	29	trocar abdominal	90
BUSCH para cordón umbilical	26	SPENCER para ligaduras	28	trocar, COAKLEY para seno maxilar	90
CASTROVIEJO corneales	33	STEVENS para tenotomía	22	FLEURANT p. la vejiga	90
CASTROVIEJO de iridectomía	32	STRULLY neuroquirúrgicas	26	LICHTWITZ para seno maxilar	90
COTTLE nasales	23	THOREK pulmonares		MENGHINI p. aguja de	
CRAFOORD pulmonares	27	(topráicas)	27	punción del hígado	91
tijeras cuticulares	307	TOENNIS ADSON		NELSON torácico	90
DANDY neuroquirúrgicas	27	neuroquirúrgicas	26	OCHSNER torácico	90
DEAN para amígdalas	23	universales para alambre	29	PIERCE para el seno maxilar	90
DEAVER	19	VANNAS de iridectomía	33	UCKERMANN	245
DEBAKEY vasculares y torácicas	24	tijeras vasculares/coronarias	23	trócar universal abdominal	90
p. vendajes		WAGNER	29	TROELTSCH pinza nasal	214
de acción excéntrica	30	WERTHEIM p. preparación	25	WILDE pinza nasal	203
DOYEN ginecológicas	25	WESTCOTT de iridectomía	39	TROEMNER martillo	6



	Página		Página		Página
TROUSSEAU		VOLKMANN cucharilla		WINTER pinza p.	
dilatador traqueal	245	cortante	119,120	aborto y placenta	304
TROUTMAN CHRIS rompe hojas	13	separador	69,70	WITTNER pinza p. biopsia	293
Colibri pinza para iris	189	VOLTOLINI espéculo nasal	212	WOLFF pinza para yesos	108
pinza para rectus	191	vPETZ aparato p. suturas		WOOD CRILE porta aguja	92
tubo, ADSON de aspiración	171	intestinales	266	WRIGLEY forceps obstétricos	300
BRUENINGS de extensión	240	WACHENFELDT agrafes	104	WULLSTEIN cuchillo	
BUIE de aspiración	275	pinza para agrafes	104	en forma de hoz	210
FRAZIER de aspiración	171	WADSWORTH TODD cauterio	184	HARTMANN pinza auricular	204
FRAZIER de punción	171	WAGENER ganchito auricular	203	tijeras microquirúrgicas	
JACKSON traqueal	246	MOSHER tubo salvavidas	246	para oídos	207
LUER traqueal	246	WAGNER pinza para		WEITLANER separador	76
POOLE de aspiración	8	laminectomía	173	WYLIE dilatador uterino	285
WAGENER MOSHER	246	tijeras	29	YANKAUER espéculo faríngeo	214
YANKAUER de aspiración	8	WALLICH cuchara p. aborto	304	tubo de aspiración	8
Tübingen TITAN pinza para iris	191	WALSHAM pinza para		YASARGIL clips de	
Tübingen cánula para aire	196	enderezar tabique nasal	228	aneurisma	176,177
Tübingen pinza para iris	191	WALTON gubia p. cuerpos		YEOMAN pinza de biopsia rectal	275
Tübingen pinza para ligaduras	194	extranjeros y aguja	182	yesos, BEESON separador para	108
tuerca p. tornillo cortical	155	gubia p. cuerpos extranjeros	182	BERGMANN sierra para	106
TUFFIER pinza hemostática	47	saca comedones	306	HENNIG separador para	108
separador	252	WANGENSTEEN pinza	37	STILLE cizalla para	106
TURNBULL pinza p. uñas	307	porta agujas	93	tijeras para	30
TURREL pinza de biopsia rectal	275	WARTENBERG sensímetro	7	WIGMORE sierra para	106
TYDING cierra nudo	238	WATSON CHEYNE elevador	129	WOLFF pinza para	108
pinza p. coger amígdalas	237	WEBER asa	184	YOUNG aguja de repuesto	99
UCKERMANN porta-algodón	89	WECKER espátula para iris	184	boomerang porta aguja	99
trócar	245	tijeras para iris	32	pinza p. sacar prostata	267
ULRICH pinza para tapones	60	WEEK blefarostato	178	pinza tira-lengua	231
uñas, lima para	307	WEIL BLAKESLEY		separador prostático	267
perforador para	133	pinza cortante nasal	216	ZAUFAL JANSEN pinza gubia	111
pinza para	307	WEITLANER separador	76	ZENKER pinza hemostática	
RADOLF pinza p. arrancar	133	WULLSTEIN separador	76	y de disección	51
tijeras para	307	WELLS espátula p. enucleación	184	ZIEGLER blefarostato	179
TURNBULL pinza para	307	SPENCER pinza hemostática	46	cucharilla de capsulotomía	181
universal tijeras para alambre	29	WERTHEIM CULLEN		cucharilla de iridectomía	180
UNNA saca comedones	306	pinza p. histerectomía	57	dilatador lacrimal	186
US Army separador doble pareja	65	tijeras p. preparación	25	espejo frontal	4
SMITH Army tijeras p. gaza	29	WEST cincel nasal	224		
valva CASPAR lateral	80	gubia nasal	224		
CASPAR medial	80	WESTCOTT tijeras para iridectomía	39		
CLOWARD	79	tijeras para tendones	32		
COLLIN separador abdominal	86	WESTON cierranudo para			
KALLMORGEN vaginal	280	pólipos rectales	275		
KRISTELLER vaginal	278-280	WHEELER cuchillo p. discisión	180		
VAN BUREN pinza p. secuestros	117	espátula de ciclociálisis	185		
van DOREN pinza p. biopsia		WHITE pinza p. coger amígdalas	236		
uterina	292	WHITEHEAD abreboca	232		
VANNAS tijeras para iridectomía	33	WIEDER abajalengua	230		
Varifocal oftalmoscopio	2	WIENER (AUFRIEHT) lima nasal	225		
vBUREN bujía dilatadora	271	gancho para iris	182		
vendajes, BERGMANN		lima para el seno maxilar	225		
tijeras para	30	WIGMORE sierra p. yesos	106		
ESMARCH tijeras para	30	WILDE cierranudo auricular	203		
LISTER tijeras para	30	cierranudo nasal	219		
LORENZ tijeras para	30	TROELTSCH pinza auricular	203		
tijeras para universales	30	WILDER asa	184		
VERBRUGGE		dilatador lacrimal	186		
pinza para huesos	116	WILLET MARTEL pinza			
VERRES aguja de		de pericráneo	47		
neumoperitoneo	91	WILLIAMS blefarostato	178		
Viena mod. espéculo nasal	212	destornillador y sosten			
VIRCHOW cuchillo para		de tornillos	144		
cartílagos	16	pinza p. intestinos	260		
rompecráneo	124	WILLIGER cureta doble	120		
VIRTUS (RALK) pinza		martillo	125		
p. espinas	38	peristótomo	126		

## Indice delle sezioni

Gruppo		Pagina
102	Diagnostica	1- 7
104	Anestesia	8- 9
106	Bisturi, Coltelli	10- 16
108, 109	Forbici	18- 33
110, 111	Pinze per dissezione	34- 40
112	Pinze emostatiche	42- 57
112	Pinze serratubi	58
114	Pinze fissateli	59
116	Pinze per polipi e per tamponi	60- 63
118	Divaricatori	64- 87
120	Specilli, Sonde, Portacotone	88- 89
122	Trequarti, Aghi da punzione	90- 91
124, 126	Sutura	92- 104
128	Utensili per la sterilizzazione	105
130	Bendaggi gessati	106- 108
132-136	Chirurgia ossea, osteosintesi	109- 166
140	Neurochirurgia, Laminectomia	167- 177
142	Oftalmologia	178- 197
144	Otologia	198- 211
146	Rinologia	212- 229
148	Bocca e lingua	230- 234
150	Tonsille	235- 238
152	Laringe	239- 241
153	Pinze flessibili endoscopiche	242- 244
154	Tracheotomia	245- 246
154	Gozzo	247
156	Torace	248- 255
162	Vescicola biliare	256- 257
164	Rene	258
164	Intestini, Stomaco	259- 266
166	Urologia	267- 271
168	Retto	272- 275
170	Ginecologia	276- 299
172	Ostetricia	300- 305
174	Dermatologia, Igiene	306- 307
188	Contenitori, vassoi e bacinelle	308- 312
190	Chirurgia ad alta frequenza	314- 319

	Pagina		Pagina		Pagina
abassalingua, KILNER DOUGHTY	233	ALEXANDER MATSON		AUVARD specolo vaginale	282
abassalingua legno	230	periototomo	128	avvicinatore, BAILEY	
adenotomo, LAFORCE	229	periototomo	126	baby, costale	253
ADLERKREUTZ pinza	36	pinza p. biopsia	292	BAILEY GIBBON	253
ADSON baby divaricatore	77	scalpello	121	avvicinatore costale	253
baby pinza emostatica	48	sgorbia	121	AXENFELD curetta p. calazio	183
BROWN pinza p. dissezione	35	ALLIS ADAIR pinza	259	AYER pinza p. calazio	195
divaricatore	77	baby pinza	259	pinza per calazio	195
divaricatore per duramadre	168	JUDD pinza	259	BABCOCK pinza per	
elevatorio	128	pinza	259	intestini e tessuti	259
micro pinza per dissezione	35	THOMS pinza	259	BABINSKY martello	6
pinza per dissezione	35	ALLISON spatola polmonare	253	bacinella per sterilizzare	312
pinza emostatica	48	ALM divaricatore	76	bacinella	309
pinza per ipofisi	170	ALVIS curetta p. corpi estranei	182	bacinella p. strumenti	310
pinza sgorbia	110	amniotomo, BEACHAM	289	bacinella reniforme	309
port'aghi	94	amputazione, CHARRIERE		BACKHAUS fissateli	59
TOENNIS forbici		sega per	133	BAGGISH pinza per	
p. neurochirurgia	26	coltello per	15	biopsia uterina	295
tubo di aspirazione	171	LISTON coltello per	15	BAILEY avvicinatore costale	253
AEBLI forbici corneali	22	PERCY retrattore per	133	baby avvicinatore costale	253
ago, BARBARA curvo	210	ANDREW abassalingua	230	GIBBON avvicinatore costale	253
BOWMAN p. dissezione	181	anoscopio, HIRSCHMANN	274	BAINBRIDGE pinza emostatica	53
COOPER per legatura	98	IVES FANSLER	274	BAKES sonda per calcoli biliari	257
ago da iniezione tonsillare	238	ansa, BILLEAU auricolare	203	BALFOUR baby	
DAVIS per corpi estranei	181	e calamita, oculistica	197	divaricatore addominale	84
DESCHAMPS per legatura	98	SNELLEN	184	divaricatore addominale	84
DUPUY WEISS tonsillare	236	WEBER	184	BALLENGER coltello girevole	221
FRANCIS per corpi estranei	181	WILDER	184	elevatore p. setto	222
FRANKLIN SILVERMANN p.		anse per serranodi	203,219,237	HAJEK elevatore p. setto	222
biopsia del fegato	91	anse tonsill	237	pinza per tonsille	237
ago per sutura intestinale	103	apparecchio, vPETZ p.		SLUDER tonsillotomo	238
KEITH per sutura	103	sutura intestinale	266	BANGERTER spatola	
KOENIG ad amo	103	apribocca, DAVIS BOYLE	232	per ciclodialisi	184
KRONECKER per legatura	98	DENHART	231	BARANY assordatore	200
LEVINSON per corpi estranei	181	DOYEN JANSEN	231	BARBARA ago	210
LICHTWITZ p. seno mascellare	219	HEISTER	231	pick	210
MENGHINI p.biopsia del fegato	91	JENNINGS	232	uncinetto	210
NELSON per legatura	98	KILNER DOUGHTY	233	BARKAN coltello per goniotomia	181
ago p. anestesia pudendus	91	MAUNDER di legno	234	BARNHILL coltello p.	
ago p. cataratta	181	McIVOR	233	vegetazioni adenoidali	229
ago p. punzione lombare	91	PITHA di silicio	234	BARR specolo rettale	272
ago per corpi estranei	181	ROSER KOENIG	231	BARRAQUER KATZIN	
POLITZER per paracentesi	202	SEEMANN SEIFFERT	232	pinza per iride	189
REVERDIN per legatura	99	WHITEHEAD	232	BARRAQUER Colibri blefarostato	178
ROSEN	210,211	ARCHER pinza per schegge	38	Colibri pinza per iride	189
ago per sutura	102,103	arco, KIRSCHNER	140	Colibri forbici per iride	32
VERRES per pneumoperitoneo	91	arco per estensione	140	coltello per cheratoplastica	181
YOUNG di ricambio	99	Arkansas pietra per affilare	16	pinza per camera anteriore	191
agrafes, COLLIN pinza per	104	ARRUGA blefarostato	178	pinza depilatoria	197
HEGENBARTH pinza per	104	GILL pinza capsulare	192	pinza di fissaggio	192
agrafes in argento per		KALT port'aghi	97	port'aghi	97
sutura intestinale	266	pinza capsulare	193	BARRETT pinza uterina	286
McKENZIE, pinza p. applicare	166	port'aghi	96	BARTON forcipe ostetrico	301
MICHEL	104	protettore	184	trattore per forcipi ostetrici	301
MICHEL pinza per	104	uncino p. estrazione	182	BAUMGARTNER port'aghi	92
RICHTER HEATH pinza per	104	ASCH pinza p. raddrizzare		BEACHAM amniotomo	289
set per sutura con	105	per il setto	228	BECKER cistitomo malleabile	182
SMITHWICK pinza per	166	aspiratore, DASTOOR capsulare	185	BECKMANN coltello p.	
SWEET pinza per	166	assordatore, BARANY	200	vegetazioni adenoidali	229
WACHENFELDT	104	astuccio, tascabile	105	divaricatore	78
WACHENFELDT pinza per	104	GUYON set di		EATON divaricatore	78
ALAN PARKS specolo rettale	273	dilatatori completo	270	BEEBEE forbici	29
ALBEE fresa	137	astuccio p. sutura	105	BEER pinza depilatoria	197
alesatore, CRUTCHFIELD	167	set per tracheotomia		BEESON divaricatore per gessi	108
KUENTSCHER, per femore	143	AUFRIECHT divaricatore nasale	227	BELLUCCI forbici micro auricolari	205
alesatore p. chiodi		raspa nasale	224	benda per emostasi „clip“	2
centromidollari	142	autopsia, set di strumenti per	124	BENGOLEA pinza emostatica	48

	Pagina		Pagina		Pagina
BENNETT elevatore p. ossa	129	pinza sgorbia	111	capsula in acciaio 18/10	309
BERENS cheratomo	180	BOERMA forcipe ostetrico	302	CARMALT pinza per schegge	38
BERGMANN forbici per bendaggi	30	BOETTCHER forbici tonsillari	23	ROCHESTER pinza emostatica	46
sega per gessi	106	BONACCOLTO pinza		CARPENTER coltello	
BERKE pinza muscolare	191	per strabismo	190	tonsillare e dissettore	235
BERLINER martello	6	Bonn cannula per irrigazione	196	coltello tonsillare	
BERNHARD fissateli	59	Bonn pinza per iride	190,191	ed enucleatore	235
BERTILLON cefalometro	7	Bonn TITAN pinza per iride	191	CASPAR divaricatore	80-82
BEST pinza intestinale	263	BORCHARDT fresa olivare	137	divaricatore per tessuti morbidi	80
BETHUNE costotomo	249	BOSE divaricatore tracheale	245	specolo lombare vertebrale	82
BEUSE forbici	23	uncino tracheale	245	CASTANEDA ALU	
BEYER pinza sgorbia	111	BOUCHERON specolo auricolare	198	divaricatore costale	252
pinza ossivora	218	BOWLES FORD stetoscopio	5	CASTROVIEJO blefarostato	179
bicchieri graduato	310	stetoscopio	5	cheratomo	180
BILL LUIKART trattore		BOWMAN ago p. disissione	181	compasso marcatore	185
per forcipi ostetrici	302	blefarostato	178	dilatatore lacrimale	186
trattore p. forcipi ostetrici	302	coltello p. discissione	180	forbici corneale	33
BILLEAU ansa auricolare	203	specillo lacrimale	186	forbici per iride	32
bipolare, pinza per		BOYNTON port'aghi	96	forbici per iridectomia	32
coagulazione	316-318	BOZEMANN DOUGLAS		pinza capsulare	193
BIRCHER GANSKE		pinza p. polipi	63	pinza fissatrice	192
tenaglia p. ossa	117	pinza per polipi	63	pinza per sutura	194
meniscotomo	131	port'aghi	93	port'aghi	97
BISHOP HARMAN pinza per iride	190	BRAUN cranioclasto	305	rompe lamette	13
bisturi, COLLIN manico per	10	depressore uterino	289	spatola per ciclodialisi	184,185
CONVERSE p. plastica nasale	220	pinza uterina	286	trapano	196
COTTLE p. plastica nasale	220	SIMPSON forcipe ostetrico	300	cavachiodi, gancio	143
FREER per mucosa	220	STADLER forbici p. episiotomia	26	KUENTSCHER	143
HALLE p. duramide	170	uncino p. decapitazione	305	cavo, bipolare	319
JOSEPH nasale	220	BREISKY specolo	282	cefalometro, BERTILLON	7
lame da sterili	11	BROWN ADSON pinza		cesoia, BOEHLER per ossa	113
bisturi con manico di metallo	14	per dissezione	35	COTTLE KAZANJIAN p. ossa	113
manico	10	BRUENINGS abassalingua	230	LISTON per ossa	113
PARKER	14	coltello per setto	221	RUSKIN LISTON p. ossa	113
SEGOND per fibromi	296	pinza tagliente nasale	215	SEMB per ossa	114
bisturi uso unico sterili	12	punta di pinza laringeale	240	STILLE HORSLEY p. ossa	114
BLAKE curetta uterina doppia	297	serranodi tonsillare	237	STILLE LISTON p. ossa	113
MAYO pinza per calcoli biliari	256	specolo auricolare pneumatico	198	CHAPUT pinza emostatica	47
pinza calcoli biliari	256	tubo di allungamento		CHARRIERE sega per	
blefarostato, ARRUGA	178	per pinze laringeali	240	amputazione	133
BARRAQUER Colibri	178	BRUNETTI scalpello spinale	124	CHEATLE pinza per strumenti	
BOWMAN	178	BRUNNER condottiere di		sterilizzati	105
CASTROVIEJO	179	legno artificiale	100	cheratomo, BERENS	180
CLARK	178	costotomo	249	CASTROVIEJO	180
CRITCHETT	178	pinza intestinale	263	JAEGER	180
GOLDSTEIN	179	sonda conduttrice	100	CHERON pinza per polipi	62
GRAEFE	178	BRUNS curetta tagliente	119,120	CHEVALIER JACKSON pinza	241
LANCASTER	179	forbici per bendaggi	30	CHILDE pinza p. avvicinare	
LISTER BURCH	178	BRYANT pinza per medicazione	62	bordi della ferita	104
MELLINGER	178	BUCHWALD abassalingua	230	chiodo, BOEHLER	149
MELLINGER AXENFELD	178	BUCK coltello auricolare	202	chiodo a gancio	146
MUELLER	179	curetta auricolare	201	JEWETT	150
MURDOCK	178	leva p. corpi estranei	204	KUENTSCHER	147,148
PARK	179	martello	6	SMITH PETERSEN	149
SMITH	178	BUIE SMITH divaricatore rettale	273	STEINMANN p. ossa	139
STEVENSON	179	tubo di aspirazione	275	CINELLI scalpello p. plastica	223
WEEK	178	BUMM curetta uterina	299	cistotomo, BECKER	182
WILLIAMS	178	BUNGE curetta p. palpebre	183	GRAEFE	182
ZIEGLER	179	BUNNELL perforatore a mano	135	CITELLI pinza ossivora	218
BLOHMKE pinza per tonsille	237	scollatendini	132	clamp, CRAFOORD	
BLOUNT elevatore per ginocchio	131	BUNT pinza p. sterilizzazione	105	pinza bronchiale	51
elevatore per ossa	131	BURCH forchetta di fissaggio	181	GREEN ARMYTAGE pinza	
BLUMENTHAL pinza sgorbia	109	LISTER blefarostato	178	uterina	303
BODENHAMMER specolo rettale	272	BURKE pinza p. biopsia uterina	294	LANE pinza stomacale	265
BOEHLER arco p. estensione	140	BUSCH forbici ombelicali	26	MOYNIHAN pinza	54
cesoia per ossa	113	cacciavite p. vite cannulate	145	SAROT pinza bronchiale	51
chiodo per ossa	149	cannula, KILLIAN, per irrigazione	219	CLAR lampada frontale	4

	Pagina		Pagina		Pagina
CLARK blefarostato	178	TABB falciforme	210	SIMON uterino tagliente	297
CLEVELAND pinza sgorbia	109	TOOK corneale	181	WALLICH p. aborto	304
clip, YASARGIL		VIRCHOW p. cartilagine	16	CULLER spatola per iride	184
per aneurisma	176,177	WHEELER p. discissione	180	curetta, ALVIS p. corpi estranei	182
CLOWARD divaricatore	79	WULLSTEIN falciforme	210	AXENFELD p. calazio	183
divaricatore vertebrale	171	ZIEGLER per capsulotomia	181	BLAKE uterina doppia	297
COAKLEY curetta per		ZIEGLER per iridectomia	180	BRUNS tagliente	119,120
seno mascellare	228	COLVER pinza per tonsille	236	BUCK auricolare	201
tre quarti per seno mascellare	90	compressore, CORWIN p. tonsille	237	BUMM uterina	299
COLCLOUGH pinza ossivora	175	condottiere, BRUNNER		BUNGE p. palpebre	183
COLLIER port'aghi	92	legno artificiale	100	COAKLEY per seno mascellare	228
COLLIN dinamometro	2	CONNIN AMSLER marcatore	185	DAVIEL p. cataratta	183
divaricatore addominale	86	CONVERSE bisturi per		FAULKNER tagliente	228
DUVAL pinza	36	plastica nasale	220	FOX per lupus	306
HARTMANN divaricatore	65	COOLEY Atrauma pinza	40	GRAEFE p. cataratta	183
isterometro	289	COOPER ago per legatura	98	HALLE malleabile	120
manico per bisturi	10	CORDES punta di pinza laringeale	240	HEBRA p. calazio	183
martello	125	cordotomo, FRAZIER	170	HOUSE doppia	211
pelvimetro	303	CORWIN compressore p. tonsille	237	KEVORKIAN per biopsia uterina	290
pinza emostatica	47	CORYLLOS costotomo	249	KNAPP per cataratta	183
pinza isterolabo	288	divaricatore (toracale)	75	LEMPERT	120
pinza ombelicale	303	COS pinza p. filo metallico	206	MARTINI doppia	120
pinza per agrafes	104	costotomo	248	MEYHOEFER p. calazio	183
pinza per polipi	62	costotomo, BETHUNE	249	NOVAK di aspirazione	
pinza tirilingua	231	BRUNNER	249	per biopsia uterina	290
specolo vaginale	276	CORYLLOS	249	PESTALOZZA per aborto	304
COLLYER pelvimetro	303	GIERTZ STILLE	249	PIFFARD p. lupus	306
coltello, BALLENGER girevole	221	GLUCK	248	RANDALL di aspirazione	
BARKAN per goniotomia	181	SAUERBRUCH	249	per biopsia uterina	290
BARNHILL p. vegetazioni		SAUERBRUCH FREY	249	RECAMIER uterina	299
adenoidali	229	STILLE	248	SCHEDE tagliente	119
BARRAQUER		COTTLE bisturi per plastica nasale	220	SIMON tagliente	120
p. cheratoplastica	181	coltello per plastica nasale	220	SIMS uterina	299
BECKMANN p. vegetazioni		divaricatore	227	SPRATT tagliente	119
adenoidali	229	elevatore p. setto	222	VOLKMANN tagliente	119,120
BOWMAN p. discissione	180	forbici nasali	23	WILLIGER doppia	120
BRUENINGS per setto	221	KAZANJIAN cesoia p. ossa	113	CUSCO specolo vaginale	276,277
BUCK auricolare	202	NEIVERT divaricatore doppio	227	CUSHING divaricatore	69
CARPENTER e dissettore		periototomo	222	divaricatore per nervi	168
tonsillare	235	scalpello p. plastica	223	perforatore piatto	134
CARPENTER ed enucleatore		specolo nasale	213	pinza per dissezione	35
tonsillare	235	COXETER sonda prostatica	271	pinza per laminectomia	172
COTTLE per plastica nasale	220	CRAFOORD forbici pulmonari	27	spatola cerebrale	171
DEAN p. iridectomia	180	pinza clamp bronchiale	51	CUZZI cucchiaino p. aborto	304
DEUTSCHMANN p. cataratta	179	cranioclasto, BRAUN	305	CZERNY specolo rettale	272
ELSCHNIG corneale	181	TARNIER	305	dado p. viti corticali	155
ESMARCH p. gesso	108	Credo lametta di ricambio	307	DANDY forbici neurochirurgiche	27
FREER p. setto	220	Credo tagliacalli	307	pinza emostatica	46
GILL corneale	181	CRILE divaricatore doppio	65	uncino per nervi	168
GRAEFE p. cataratta	179	MURRAY port'aghi	92	DARLING divaricatore	79
HOPKINS p. gesso	108	pinza emostatica	45	DARTIGUES pinza isterolabo	288
JOSEPH p. plastica	220	port'aghi	94	DASTOOR aspiratore capsulare	185
KNAPP p. iridectomia	180	RANKIN pinza emostatica	45	pinza per strabismo	190
LANGENBECK p. resezione	15	TITAN pinza emostatica	45	DAVIDSON divaricatore	
MUCK periostale	211	WOOD port'aghi	92	per scapula	75
coltello p. cervello	16	CRITCHETT blefarostato	178	DAVIEL curetta p. cataratta	183
PAUFIQUE p. cheratoplastica	181	CRUTCHFIELD alesatore	167	DAVIS ago per corpi estranei	181
coltello per amputazione	15	trazione craniale	167	BOYLE abassalingua	232
PLESTER lobare	210	cucchiaino, CUZZI p. aborto	304	BOYLE apribocca	232
REINER p. gesso	108	DESJARDINS p. calcoli biliari	257	dissettore per duramadre	169
ROSEN circolare	210	FERGUSSON p. calcoli biliari	257	pinza p. afferrare siringhe	105
SATO corneale	181	GUTMANN p. secrezioni	270	DAY uncino auricolare	203
SCHEIE per goniotomia	181	MAYO p. calcoli biliari	257	DE BAKEY port'aghi	93
SCHUKNECHT circolare	210	MOORE p. calcoli biliari	256	de LEE forcipe ostetrico	300
SCHUKNECHT falciforme	210	pinza auricolare per		De MARTEL guida sega	169
SEXTON auricolare	202	microchirurgia	205-209	POTTS MARTEL forbici vascolari	23
StCLAIR THOMSON	229	SELLHEIM ostetrico	305	DEAN coltello p. iridectomia	180



Pagina	Pagina	Pagina			
forbici tonsillari . . . . .	23	dissetto, DAVIS per duramadre . . . . .	169	HAIGHT . . . . .	252
DEAVER divaricatore . . . . .	67	GREEN corneale . . . . .	182	HARRINGTON . . . . .	67
forbici . . . . .	19	HURD p. tonsille . . . . .	235	HEANEY . . . . .	74
DEBAKEY Atrauma pinza . . . . .	40	LANGE curetta e per		HENNIG per gessi . . . . .	108
forbici vascolari e toracali . . . . .	24	sacco lacrimale . . . . .	184	HOFER pillare . . . . .	235
forbici vascolari . . . . .	24	MILLIGAN per duramadre . . . . .	169	INGE vertebrale . . . . .	171
pinza Bulldog Atrauma . . . . .	41	PATON corneale . . . . .	181	ISRAEL . . . . .	73
DEJERINE martello . . . . .	6	dissetto per duramadre . . . . .	169	JANSEN . . . . .	76
DeMARTEL WOLFSON		SACHS per duramadre . . . . .	169	JUDD MASSON vescicale . . . . .	268
pinza p. anastomosi . . . . .	264	TOENNIS per duramadre . . . . .	169	KELLY . . . . .	66,74
DeMARTEL WOLFSON		ditale, LANGENBECK . . . . .	234	KIRSCHNER addominale . . . . .	85
pinza p. anastomosi . . . . .	264	divaricatore . . . . .	64-87	KNAPP . . . . .	182
DeMARTEL WOLFSON		divaricatore, ADSON . . . . .	77	KOCHER . . . . .	72,73
portapinze . . . . .	264	ADSON baby . . . . .	77	KOERTE . . . . .	73
DeMARTEL WOLFSON serrapinze . . . . .	264	ADSON per duramadre . . . . .	168	divaricatore per labbra e guance . . . . .	231
DENHART apribocca . . . . .	231	ALM . . . . .	76	LAHEY . . . . .	70
depressore, BRAUN uterino . . . . .	289	AUFRIEHT nasale . . . . .	227	LANGENBECK . . . . .	71
SIMS uterino . . . . .	289	BALFOUR addominale . . . . .	84	LEGUEU vescicale . . . . .	269
DERF port'aghi . . . . .	92	BALFOUR baby addominale . . . . .	84	LITTLE . . . . .	70
dermotomo, SCHINK . . . . .	15	BECKMANN . . . . .	78	LOVE per radici, di nervi . . . . .	168
DESCHAMPS ago per legatura . . . . .	98	BECKMANN EATON . . . . .	78	LOVE per uvula . . . . .	235
DESJARDINS cucchiaino		BEESON per gessi . . . . .	108	MATHIEU doppio coppia . . . . .	65
per calcoli biliari . . . . .	257	BOSE tracheale . . . . .	245	MERCEDES toracale . . . . .	253
pinza per calcoli biliari . . . . .	256	CASPAR . . . . .	80-82	MEYERDING . . . . .	70
pinza p. condotto biliare . . . . .	54	CASTANEDA ALU costale . . . . .	252	MIDDELDORPF . . . . .	72
sonda per calcoli biliari . . . . .	257	CLOWARD . . . . .	79	MIKULICZ . . . . .	74
DESMARRES divaricatore		CLOWARD vertebrale . . . . .	171	MILLIN per il collo della vescica . . . . .	269
(anche per palpebre) . . . . .	69	COLLIN addominale . . . . .	86,87	MOLLISON . . . . .	79
pinza per calazio . . . . .	195	COLLIN HARTMANN . . . . .	65	divaricatore muscolare . . . . .	87
DEUTSCHMANN		CORYLLOS (toracale) . . . . .	75	NAGER palatale . . . . .	235
coltello p. cataratta . . . . .	179	COTTLE . . . . .	227	O'SULLIVAN O'CONNOR	
DeVILBISS pinza craniale . . . . .	169	COTTLE NEIVERT doppio . . . . .	227	addominale . . . . .	83
DEWEY forcipe obstetrico . . . . .	302	CRILE doppio . . . . .	65	OLLIER . . . . .	72
diagnostica, set per . . . . .	3	CUSHING . . . . .	69	divaricatore p. gessi . . . . .	108
Diamant tagliafilari . . . . .	142	CUSHING per nervi . . . . .	168	PARKER dopp. coppia . . . . .	64
diapason, alluminio . . . . .	199	DARLING . . . . .	79	PLESTER . . . . .	76
HARTMANN . . . . .	199	DEAVER . . . . .	67	REVERDIN addominale . . . . .	66
LUCAE . . . . .	200	DESMARRES		RIBBON . . . . .	66
diapason neurologico . . . . .	200	(anche per palpebre) . . . . .	69	RICHARDSON . . . . .	66
RYDEL SEIFFER . . . . .	200	divaricatore doppio . . . . .	87	RICHARDSON EASTMAN . . . . .	66
DIEFFENBACH serrafina . . . . .	42	DOYEN addominale . . . . .	74	RIGBY rettale, vaginale . . . . .	86
DIETER pinza p. testa di martello . . . . .	206	FARABEUF doppio coppia . . . . .	64	ROLLET . . . . .	182
DIETHRICH port'aghi . . . . .	96	FINOCHIETTO ALU costale . . . . .	250	ROUX . . . . .	64
dilatatore CASTROVIEJO		FINOCHIETTO ALU infant		SACHS p. nervi . . . . .	168
lacrimale . . . . .	186	costale . . . . .	250	SAUERBRUCH . . . . .	75
GOODELL uterino . . . . .	285	FINOCHIETTO BURFORD		SCHOENBORN p. tiroide . . . . .	247
GUYON candeletta . . . . .	271	costale . . . . .	251	SENN doppio . . . . .	66
HANK uterino . . . . .	285	FINOCHIETTO BURFORD		SENN GREEN . . . . .	69
HEGAR uterino . . . . .	283,284	ALU costale . . . . .	251	SIMON addominale . . . . .	74
LABORDE tracheale . . . . .	245	FINOCHIETTO costale . . . . .	250	SMITH BUIE rettale . . . . .	273
SIMS uterino . . . . .	285	FINOCHIETTO baby costale . . . . .	250	SMITHWICK p. nervi . . . . .	168
TROUSSEAU tracheale . . . . .	245	FINSEN . . . . .	76	divaricatore a molla . . . . .	68
vBUREN candeletta . . . . .	271	FOMON p. coane . . . . .	227	STERNBERG per labbra . . . . .	230
WILDER lacrimale . . . . .	186	FOMON p. le pinne . . . . .	227	TAYLOR per la spina . . . . .	131
WYLIE uterino . . . . .	285	FRAZIER . . . . .	83	THOMSON WALKER vescicale . . . . .	268
ZIEGLER lacrimale . . . . .	186	FRIEDMAN per perineorrafia . . . . .	282	TUFFIER . . . . .	252
astuccio tascabile . . . . .	105	FRITSCH . . . . .	73	US Army doppio coppia . . . . .	65
calamita oculistica con ansa . . . . .	197	GELPI perineale . . . . .	86	VOLKMANN . . . . .	69,70
diapason . . . . .	199	GERSTER per tenaglie per ossa . . . . .	118	WEITLANER . . . . .	76
divaricatore . . . . .	76	GOELET doppio . . . . .	65	WEITLANER WULLSTEIN . . . . .	76
forbici p. bendaggi eccentrica . . . . .	30	GOSSET addominale . . . . .	83	YOUNG prostatico . . . . .	267
portacotone . . . . .	89	GRAHAM per nervi . . . . .	168	divisore, VIRCHOW p. cranio . . . . .	124
rompe lamette . . . . .	13	GREEN . . . . .	72	DIX ago e scalpello . . . . .	185
taglia anelli . . . . .	133	divaricatore per guance e labbra . . . . .	231	ago e sgorbia . . . . .	185
dinamometro, COLLIN . . . . .	2	HABERER malleabile . . . . .	66	scalpello p. corpi estranei . . . . .	182
DINGMANN tenaglia per ossa . . . . .	117	HAGLUND STILLE per gessi . . . . .	108	DOUGLAS BOZEMANN	
disco p. limitare taglio . . . . .	138			pinza p. polipi . . . . .	63

	Pagina		Pagina		Pagina
pinza depilatoria	197	FARREL portacotone	89	DANDY neurochirurgiche	27
trequarti e cannula	90	fascia frontale	4	DEAN tonsillari	23
DOYEN baby pinza intestinale	260	FAULKNER curetta tagliente	228	DEAVER	19
divaricatore addominale	74	FAURE pinza p. biopsia uterina	291	DEBAKEY vascolari/toracali	24
fissateli	59	pinza per peritoneo	56	DEBAKEY vascolari	24
forbici ginecologiche	25	FEHLAND pinza intestinale	263	p. bendaggi	30
fresa	137	FEILCHENFELD pinza per schegge	38	DOYEN ginecologiche	25
JANSEN apribocca	231	FERGUSON cucchiaino		DUBOIS ginecologiche	25
periototomo costale	127	p. calcoli biliari	257	ESMARCH per bendaggi	30
pinza intestinale	260	pinza p. pressione progressiva	46	FOMON nasali	22
pinza per polipi uterini	288	tenaglia per ossa	114	GILLIES port'aghi con forbici	95
specillo scanalato	88	FERRIS SMITH KERRISON		HEATH per legature	28
specolo vaginale	281	pinza ossivora	174	HEYMANN nasali	22
tiramioni	296	SMITH pinza per dissezione	36	JOSEPH	21
DUBOIS forbici ginecologiche	25	SMITH pinza per laminectomia	173	KELLY ginecologiche	25
DUPLAY pinza uterina	286	filo p. ossa malleabile	141	KILNER	21
Duplex stetoscopio	5	FINOCHIETTO ALU		KLINKENBERGH LOTH toracali	27
DUPUY WEISS ago tonsillare	236	divaricatore costale	250	KNOWLES p. bende delle dita	30
DUVAL COLLIN pinza	36	FINOCHIETTO ALU		LEXER baby	20
pinza p. intestini e tessuti	260	infant divaricatore costale	250	LISTER per bendaggi	30
ECHLIN pinza sgorbia	112	FINOCHIETTO BURFORD ALU		LITTAUER per legature	28
Econom set per diagnostica	3	divaricato costale	251	LORENZ per bendaggi	30
Econom sfigmomanometro	1	FINOCHIETTO BURFORD		MAYO (HARRINGTON)	19
elettrodo per coagulazione		divaricatore costale	251	MAYO	19
per AF	314,315	FINOCHIETTO baby		MAYO NOBLE	19
elevatore, BALLENGER p. setto	222	divaricatore costale	250	MAYO	19
BENNETT p. ossa	129	divaricatore costale	250	MAYO STILLE	19
BLOUNT per ginocchio	131	pinza bronchiale	254	McGUIRE corneali	32
BLOUNT per ossa	131	port'aghi	94	McINDOE per cartilagini	27
COTTLE p. setto	222	FINSEN divaricatore	76	METZENBAUM	20,21
FREER per setto	221	FISCH scollatore	211	micro	33
HENKE p. tonsille	235	FISCHER pinza p. iride	189	forbici micro per otologia	205,207
HOHMANN p. ossa	129,130	fissateli, BACKHAUS	59	micro ginecologiche	33
KILLIAN p. setto	222	BERNHARD	59	NORTHBENT (SPENCER)	
LEMPERT	211	DOYEN	59	per legatura	28
McDONALD doppio	129	JONES	59	NOYES per iride	32
McKENTY p. setto	221	LANE	59	forbici ombelicali	26
elevatore per ossa	130	LORNA	59	forbici p. enterotomia	28
elevatorio, ADSON	128	MOYNIHAN	59	forbici p. parametrio	24
FREER per setto	221	pinza	59	forbici p. cuticola	307
HAJEK BALLENGER p. setto	222	ROEDER	59	forbici p. unghie	307
KEY	128	SCHAEDEL	59	forbici per bende universali	30
LANGENBECK	128	FLEURANT trequarti p. vescica	90	forbici per enucleazione	22
MURPHY LANE doppio	129	FOERSTER pinza p. iride	188	forbici per gessi	30
ROGER per setto	221	pinza p. iride	188	forbici per guance	29
WATSON CHEYNE doppio	129	pinza p. spugne	61	forbici per incisioni	19
ELLIOT forcipe ostetrico	300	FOMON divaricatore p. coane	227	forbici per iris	21
trapani	197	divaricatore p. le pinne	227	forbici per preparazione di nervi	26
ELLIS sgorbia p. corpi estranei	182	forbici nasali	22	forbici per preparazioni	26
ELSCHNIG coltello corneale	181	raspa nasale	225,226	forbici per strabismo	22
pinza capsulare	193	scalpello	223	POTTS DE MARTEL vascolari	23
pinza fissatrice	192	fonendoscopio, PINARD	5	POTTS SMITH vascolari	24
spatola p. ciclodialisi	184	forbici, AEBLI corneali	22	QUINBY per guance	29
EMMET uncino fistolare	296	BARRAQUER Colibri per iride	32	REYNOLDS	21
endospecolo, KOGAN	282	BEEBEE	29	SANVENERO	21
ENGEL sega per gessi	106	BELLUCCI micro	205	SATINSKY toracali	27
EPPENDORFER KEVORKIAN		BERGMANN per bendaggi	30	SCHMIEDEN TAYLOR	
pinza p. biopsia	295,296	BEUSE	23	per duramide	27
ESMARCH coltello p. gesso	108	BOETTCHER tonsillari	23	SCHUMACHER ombelicali	26
forbici per bendaggi	30	BRAUN STADLER p. episiotomia	26	SHEA micro	205
estensione, arco per	140	BRUNS p. bendaggi	30	SIEBOLD ginecologiche	25
BOEHLER arco per	140	BUSCH ombelicali	26	SIMS per utero	25
EVES serranodi per tonsille	237	CASTROVIEJO corneali	33	SMITH US Army p. garza	29
FARABEUF divaricatore	64	CASTROVIEJO p. iridectomia	32	SPENCER per legature	28
LAMBOTTE tenaglia p. ossa	115	forbici chirurgiche	18-27	STEVENS p. tenotomia	22
periototomo	126	COTTLE nasali	23	STILLE per gessi	106
tenaglia per ossa	114	CRAFOORD pulmonari	27	STRULLY per neurchirurgia	26

	Pagina		Pagina		Pagina
THOREK pulmonari e toracali	27	FRITSCH divaricatore	73	GUTMANN	
TOENNIS ADSON		FUCHS pinza capsulare	193	cucchiaio p. secrezioni	270
neurochirurgiche	26	GALLAHER lima per ossa		GUYON candeletta dilatatrice	271
universali per filo metallico	29	raspa per senò	226	mandrino p. sonde in gomma	270
VANNAS per iridectomia	33	gancio cavachiodi	143	MAYO pinza p. peduncolo	55
forbici vascolari/coronarie	23	gancio uncinato	146	pinza p. peduncolo renale	55
WAGNER	29	GAUSS pinza per pericranio	303	set dilatatore in astuccio	270
WECKER per iride	32	GELLHORN pinza p.		GUYTON LUNDSGAARD	
WERTHEIM p. preparazione	25	biopsia uterina	292	sclerotomo	181
WESTCOTT p. iridectomia	39	GELPI divaricatore perineale	86	HABERER divaricatore malleabile	66
WESTCOTT p. tendini	32	Gemini mini pinza		HAGLUND STILLE	
WULLSTEIN microchirurgiche	207	dissezione e passafili	49	divaricatore per gessi	108
forcipe, BARTON	301	Gemini pinza p.		HAIGHT divaricatore	252
BOERMA	302	dissezione e passafili	49	HAJEK BALLENGER elevatore	222
de LEE	300	GERALD pinza per dissezione	37	CLAUS pinza p. seno	
DEWEY	302	GERSTER divaricatore		mascellare	218
ELLIOT	300	per tenaglie per ossa	118	KOFLER pinza ossivora	218
KIELLAND	300	GERZOG martello per ossa	125	sgorbia forma V	224
KIELLAND LUIKART	301	GIERTZ STILLE costotomo	249	HALLE bisturi p. duramadre	170
LUIKART	301	GIGLI manico per sega		curetta malleabile	120
McLEAN	301	di filo metallico	169	HARTMANN specolo nasale	212
McLEAN LUIKART	301	GILL ARRUGA pinza capsulare	192	TIECK specolo nasale	213
McLEAN TUCKER	301	coltello corneale	181	HALSEY port'aghi	92
McLEAN TUCKER LUIKART	301	HESS pinza p. iride	188	HALSTED micro mosquito pinza	43
NAEGELE	300	pinza p. iride	188	mosquito pinza	43
PIPER	302	GILLIES pinza per dissezione	37	TITAN mosquito pinza	43
SIMPSON	300	port'aghi c. forbici	95	Hamburg cannula bottonuta	196
SIMPSON BRAUN	300	uncinetto fino	227	HANK dilatatore uterino	285
SIMPSON LUIKART	301	giraviti esagonale	144	HARRINGTON divaricatore	67
TARNIER	302	giraviti, LANE	144	pinza bronchiale	254
WRIGLEY	300	GLOVER pinza vascolare Atrauma	41	HARTMANN abassalingua	230
FORD BOWLES stetoscopio	5	GLUCK costotomo	248	COLLIN divaricatore	65
stetoscopio	5	GOELET divaricatore doppio	65	diapason	199
FOREGGER laringoscopio	8,9	GOLDSTEIN blefarostato	179	HALLE specolo nasale	212
FOX curetta per lupus	306	goniometro, MOELTGEN	7	HOFFMANN pinza auricolare	204
FRAENKEL pinza p.		GOOD forbici per tonsille	23	pinza auricolare	204
polipi laringeali	239	GOODELL dilatatore uterino	285	pinza per polipi nasali	214
punta di pinza laringeale	240	GOSSET divaricatore addominale	83	pinza tagliente nasale	217
FRANCESCHETTI trapano		GRADLE pinza depilatoria	197	sonda auricolare	202
per cheratomia	196	GRAEFE blefarostato	178	specolo auricolare	198
FRANCIS ago per corpi estranei	181	cistitomo	182	WULLSTEIN pinza auricolare	204
FRANKE lancetta per		coltello p. cataratta	179	HAUGH pinza auricolare	206
il prelievo di sangue	2	curetta p. cataratta	183	HEANEY divaricatore	74
FRANKLIN SILVERMANN		pinza	35	pinza p. isterectomia	57
ago p. biopsia del fegato	91	pinza fissatrice	192	port'aghi	93
FRAZIER cordotomo	170	pinza p. iride	186,187	HEATH forbici per legature	28
divaricatore	83	scarificatore	180	RICHTER pinza p. agrafes	104
tubo di aspirazione	171	TITAN uncino per strabismo	182	HEBRA curetta p. calazio	183
tubo di punzione	171	uncinetto per iride	68	HEGAR dilatatore uterino	283,284
uncinetto (per duramadre)	68	uncino p. strabismo	182	MAYO port'aghi	92
FREER bisturi per mucosa	220	GRAHAM divaricatore per nervi	168	OLSEN port'aghi	95
coltello per setto	220	GRAVE specolo vaginale	276	HEGENBARTH pinza per agrafes	104
elevatore per setto	221	GRAY pinza p. condotto biliare	54	HEIFETZ spatola cerebrale	171
scalpello per setto	222	GREEN ARMYTAGE pinza		HEISS pinza emostatica	48
sgorbia	224	hemostatica uterina	303	HEISTER apribocca	231
FRENZEL abassalingua	230	dissetto corneale	182	HENKE elevatore p. tonsille	235
fresa	134	divaricatore	72	HENNIG divaricatore per gessi	108
fresa, ALBEE	137	pinza fissatrice	192	HERRICK pinza p.	
BORCHARDT	137	SENN divaricatore	69	peduncolo renale	56
fresa conica	137	uncino muscolare	182	HESS GILL pinza p. iride	188
DOYEN	137	GREVEN pinza		pinza capsulare	193
fresa per corticalis	145	p. filo metallico	206	HEYMANN forbici nasali	22
fresa piatta	137	GROSS curetta e uncino	202	KNIGHT pinza nasale	215
TOTI	137	MAIER pinza per polipi	60	pinza tagliente nasale	215
FRIEDMAN divaricatore		GRUBER specolo auricolare	198	HEYWOOD SMITH	
per perineorrafia	282	guida p. fili Kirschner	135	pinza emorroidale	275
pinza sgorbia	109	GUTHRIE uncinetto doppio	68	HIBBS osteotomo	123

	Pagina		Pagina		Pagina
scalpello	123	coltello p. plastica	220	LUER pinza per trichiasi	195
sgorbia	123	forbici	21	KNIGHT HEYMANN pinza nasale	215
HIRSCHMANN anoscopio	274	lima per ossa	224	pinza tagliente nasale	215
HOESEL port'aghi	95	periototomo	222	KNOWLES forbici p. bende per dita	30
HOFER divaricatore pillare	235	sega nasale	227	KOCHER divaricatore	72,73
HOHMANN elevatore p. ossa	129,130	uncino per mucosa	68	pinza emostatica fina	45
mini elevatore p. ossa	130	JUDD ALLIS pinza per		pinza intestinale	261
HOKE scalpello	123	intestino e tessuti	259	sonda per gozzo	247
HOLTH pinza p.		MASSON divaricatore vescicale	268	spatola vescicale	268
capsuloiridectomia	185	JUERS pinza p. filo metallico	206	KOENIG ago ad amo per sutura	103
HOPKINS coltello p. gesso	108	JURASZ pinza p. polipi laringeali	239	ROSER apribocca	231
JOHNS pinza emostatica		KABIERSKE insoffiatore	200,201	sonda conduttrice	100
e p. condotto bil	53	KALLMORGEN specolo vaginale	280	KOERTE divaricatore	73
JOHNS serrafina	42	KALT ARRUGA port'aghi	97	KOGAN endospecolo	282
HORSLEY scollatore		pinza capsulare	193	KONRICH tamburo per	
per duramide	170	port'aghi	97	sterilizzaz.c.filtro	311
STILLE cesoia p. ossa	114	KANE pinza ombelicale	303	KRAUSE punta di pinza laringeale	240
HOUSE curetta doppia	211	KEITH ago per sutura	103	serranodi nasale	219
HUBER manico universale	240	KELLY divaricatore	66,74	serranodi auricolare	203
HUDSON perforatore completo	134	forbici ginecologiche	25	KRISTELLER specolo	
HUNTER pinza per schegge	38	grip divaricatore	66	vaginale	278-280
HURD disseettore p. tonsille	235	pinza emostatica	45	KRONECKER ago per legatura	98
INGE divaricatore vertebrale	171	pinza per polipo uterino	288	KUENTSCHER alesatore	
insoffiatore, KABIERSKE	200,201	proctoscopio	274	per femore	143
POLITZER per aria	201	RANKIN pinza emostatica	45	cavachiodi	143
IOWA pinza uterina	287	TITAN pinza emostatica	45	chiodo centromidollare	146-148
iris, forbici per	21	KERN tenaglia per ossa	115	punzone midollare	143
O'CONNOR uncino per	182	KERRISON pinza ossivora	218	strumento per conficcare chiodi	143
WIENER uncino per	182	KEVORKIAN curetta		KUHNT coltellino corneale	181
ISRAEL divaricatore	73	per biopsia uterina	290	LABORDE dilatatore tracheale	245
isterolabo, COLLIN pinza	288	EPENDORFER pinza		LAFORCE adenotomo	229
DARTIGUES pinza	288	p. biopsia uterina	296	lama di ricambio	229
SOMER pinza	288	Pacific pinza per		strumento p. corpi estranei	2
isterometro, COLLIN	289	biopsia uterina	294	LAHEY divaricatore	70
MARTIN	289	pinza per biopsia uterina	293	pinza bronchiale	254
SIMS	289	punta per pinza di		pinza p. afferrare gozzo	247
ITARD sonda auricolare	202	biopsia uterina	296	pinza p. condotto biliare	53
ITERSON uncino tracheale	245	TISCHLER pinza per		lama, LAFORCE di ricambio	229
IVES FANSLER anoscopio	274	biopsia uterina	295	LAMBERT LOWMAN	
JACKSON CHEVALIER pinza	241	TISCHLER punta per		tenaglia p. ossa	118
pinza per tamponi	239	pinza di biopsia uterina	294	pinza per calazio	195
specolo	281	TOWNSEND pinza per		LAMBOTTE FARABEUF	
tubo tracheale	246	biopsia uterina	294	tenaglia p. ossa	115
uncino tracheale	245	KEY elevatore	128	mini osteotomo	122
JACOBS pinza uterina	287	KEYES trapani cutanei	306	osteotomo	122
JAEGER cheratomo	180	KIELLAND forcipe	300	periototomo	126
placca p. palpebre	179	LUIKART forcipe	301	tenaglia per ossa	115
JAMESON pinza per strabismo	189	KILLIAN cannula per irrigazione	219	lame da bisturi sterili	11
uncino per strabismo	182	CLAUS sgorbia 'V'	224	lamette da rasoio p. microchirurgia	13
JAMISON port'aghi	93	elevatore p. setto	222	lampada, CLAR, frontale	4
JANSEN divaricatore	76	specolo per setto	213	lampadina di ricambio per CLAR	4
DOYEN apribocca	231	KILNER DOUGHTY abassalingua	233	lampadina di ricambio	
MIDDLETON pinza tagliente	219	DOUGHTY apribocca	233	per laringoscopi	9
ZAUFAL pinza sgorbia	111	forbici	21	LANCASTER blefarostato	179
pinza nasale	214	uncinetto cutaneo	306	lancetta FRANKE per prelievo	
JARCHO pinza uterina	286	KIRBY ARTHUR pinza per iride	189	di sangue	2
JATHO pinza faringeale tagliente	228	KIRK martello per ossa	125	LANDAU specolo vaginale	282
JENNINGS apribocca	232	KIRSCHNER arco di estensione	140	LANE elevatore per placche	144
JEWETT chiodo per ossa	150	divaricatore addominale	85	fissateli	59
JOBSON HORNE portacotone	89	perforatore c. guida telescopica	135	giraviti	144
JOHNS HOPKINS pinza		perforatore filiforme	139	MURPHY elevatore	129
emostatica e p. cond. bil	53	sonda conduttrice	100	pinza per dissezione	36
HOPKINS serrafina	42	KLINKENBERGH LOTH		pinza clamp stomacale	265
JOHNSON port'aghi	94	forbici toracali	27	pinza porta placche	144
JONES fissateli	59	KNAPP coltello p. iridectomia	180	pinza porta viti	144
JOSEPH (LEWIS) raspa nasale	225	curetta per cataratta	183	tenaglia per ossa	115
bisturi nasale	220	divaricatore	182	LANG curetta e disseettore	184



	Pagina		Pagina		Pagina
LANGE punta di pinza laringeale	240	tenaglia p. ossa	118	port'aghi	95
LANGENBECK coltello p. resezione	15	LUBET BARBON pinza p. polipi nasali	215	specolo rettale	272
ditale	234	LUC pinza tagliente nasale	216	MATSON ALEXANDER	
divaricatore	71	LUCAE diapason	200	periototomo	128
elevatore	128	pinza auricolare	203	periototomo	128
periototomo	126	LUER KNAPP pinza per trichiasi	195	MAUNDER apribocca di legno	234
sega a dita	133	pinza sgorbia	110	MAY oftalmoscopio	2
tenaglia per ossa	114	STILLE pinza sgorbia	111	MAYO (HARRINGTON) forbici	19
laringoscopio, FOREGGER	8,9	tubo tracheale	246	BLAKE pinza p. calcoli biliari	256
McINTOSH	8,9	LUIKART BILL trattore per forcipi	302	cucchiaio per calcoli biliari	257
LAWRENCE pinza emostat./p. dissez. e per legatura	52	forcipe	301	forbici	19
LEBSCHKE scalpello sternale	124	KIELLAND forcipe	301	GUYON pinza p. peduncolo renale	55
LEGUEU spatola vescicale	268	McLEAN forcipe	301	HEGAR port'aghi	92
LEKSELL(STILLE)pinza sgorbia	112	SIMPSON forcipe	301	NOBLE forbici	19
LEMPERT curetta	120	LUNDGAARD GUYTON		pinza p. sterilizzazione	105
elevatore	211	sclerotomo	181	ROBSON pinza intestinale	262
pinza sgorbia	110	sclerotomo	181	sonda per calcoli renali	258
LERCHE pinza per dissezione	36	LUNIATSCHEK otturatore p. garza	235	STILLE forbici	19
LERICHE pinza emostatica	48	LURZ pinza ureterale	258	MAYO(HARRINGTON)forbici	19
LESTER pinza fissatrice	192	MAGILL pinza per introdurre sonde	8	McCULLOUGH pinza p. strabismo	189
leva, BUCK p. corpi estranei	204	MAISONNEUVE uretrotomo	269	McDONALD elevatore doppio	129
QUIRE p. corpi estranei	204	MALTZ (COTTLE) raspa nasale	225	McGEE pinza p. filo metallico	206
LEVINSON ago per corpi estranei	181	mandrino, GUYON p. sonde in gomma	270	McGEE uncinetto	211
LEWIN tenaglia per ossa	117	mandrino Jacobs	136	McGUIRE forbici corneali	32
LEXER baby forbici	20	manico, BILL trattore, per forcipi	302	McINDOE forbici per cartilagini	27
forbici	20	manico con mandrino Jacobs	136	McINDOE pinza per dissezione	36
mini scalpello	123	HUBER universale	240	McINTOSH laringoscopio	8,9
mini sgorbia	123	manico per bisturi	10	McIVOR apribocca	233
scalpello	123	manico per specchi laringeali	241	McKENTY elevatore p. setto	221
sgorbia	123	mano di piombo	118	McKENZIE perforatore	134
LICHTWITZ ago per il seno mascellare	219	marcatore, CASTROVIEJO		McKENZIE pinza p. applicare agrafes	166
tre quarti per il seno mascellare	90	compasso	185	McLAUGHLIN placca	149
lima, GALLAHER per ossa		CONNIN AMSLER	185	McLEAN forcipe	301
JOSEPH per ossa	224	MARSCHIK pinza tonsillare	237	McLEAN LUIKART forcipe	301
lima per ossa	132	MARTEL De, guida sega	169	McLEAN TUCKER forcipe	301
lima per unghie	307	pinza p. cuoio capelluto	47	McLEAN TUCKER LUIKART forcipe	301
PUTTI per ossa	132	WILLET pinza per cuoio capelluto	47	McPHERSON pinza p. legatura	194
LISTER (sinus) pinza p. medicazione	62	martello	125	McPHERSON TITAN pinza p. legatura	194
BURCH blefarostato	178	martello, BABINSKY	6	MEAD martello per ossa	125
forbici per bendaggi	30	BERLINER	6	pinza sgorbia	109
LISTON cesoia per ossa	113	BUCK	6	MEEKER pinza emostat./p. dissez. e passafili	52
coltello p. amputazione	15	martello con fessura	143	MELLINGER AXENFELD	
RUSKIN cesoia p. ossa	113	DEJERINE	6	blefarostato	178
STILLE cesoia p. ossa	113	GERZOG	125	blefarostato	178
LITTAUER forbici per legature	28	KIRK	125	MENGHINI ago p. biopsia del fegato	91
pinza auricolare	204	martello, manico uncinato	125	siringa p. aspirazione	91
pinza depilatoria	197	martello materiale artificiale	125	tre quarti p. ago da punzione	91
pinza per polipi nasali	215	martello pieno di piombo	125	meniscotomo, BIRCHER	131
LITTLE divaricatore	70	QUISLING intranasale	125	NEFF	131
LLOYD strumento p. conficcare e cavare chiodi	144	TAYLOR	6	SMILLIE	131
LORENZ forbici per bendaggi	30	TRAUBE	6	MERCEDES divaricatore toracale	253
LORNA fissateli	59	TROEMNER	6	METZENBAUM fino forbici	20
LOUTE strumento tendifilo	141	MARTIN isterometro	289	forbici	20,21
LOVE divaricatore per radici dei nervi	168	pelvimetro	303	port'aghi	94
divaricatore per uvula	235	St., pinza p. sutura	194	MEYERDING divaricatore	70
GRUENWALD pinza per laminectomia	172	tenaglia p. cartilagini	117	MEYHOEFER curetta p. calazio	183
LOVELACE pinza emostatica	46	MARTINI curetta doppia	120	MICHEL agrafes	104
pinza polmonare	254	maschio p. vite cannulate	145	pinza per agrafes	104
LOWER pinza p. condotto biliare	53	MASSON JUDD divaricatore vescicale	268	specchio	214
LOWMAN LAMBERT tenaglia p. ossa	118	port'aghi	93	micro forbici	33
		MASTIN pinza muscolare	247		
		MATHIEU divaricatore doppio	65		
		pinza p. corpi estranei	269		



	Pagina		Pagina		Pagina
micro pinza	39	OLDBERG pinza per laminectomia	173	OVERHOLT doppio	128
MICULICZ pinza per peritoneo	56	oliva auricolare	201	SEDILLOT	126
MIDDELDORPF divaricatore	72	oliva nasale	201	SEMB costale	127
MIDDLETON JANSEN		PIERCE trequarti per		WILLIGER	126
pinza tagliente	219	seno mascellare	90	PERTHES perforatore	138
MIKULICZ divaricatore	74	OLIVECRONA pinza sgorbia	110	PESTALOZZA curetta per aborto	304
MILLIGAN dissetto		sega filo metallico	169	PETRI scatola c. coperch	310
per duramadre	169	spatola cerebrale	171	PHANEUF pinza per peritoneo	56
MILLIN divaricatore per		TOENNIS pinza p. agrafes	166	piastra per tendere la pelle	15
il collo vescicale	269	OLLIER divaricatore	72	pick	211
pinza p. capsula prostatica	267	OLSEN HEGAR port'aghi	95	pick, BARBARA	210,211
pinza per lobuli anteriori	267	orologio, pinza di	38	PIERCE trequarti p. seno	
pinza portalegatura	267	osteotomo	121	mascellare	90
miniclip, YASARGIL,		osteotomo, BEYER pinza	218	pietra, Arkansas per affilare	16
per aneurisma	176,177	CITELLI pinza	218	PIFFARD curetta p. lupus	306
MIXTER baby pinza emostatica	52	HIBBS	123	PINARD fonendoscopio	5
O'SHAUGNESSY		LAMBOTTE	122	pinza flessibile	242-244
pinza emostatica	53	STILLE	121	pinza, ADLERKREUTZ	36
pinza per calcoli biliari	256	otoscopia, set per	3	ADSON per dissezione	35
pinza emostat./bronquiale		otturatore, LUNIATSCHEK		ADSON baby emostatica	48
e p. cond. biliare	53	p. garza	235	ADSON BROWN	35
pinza emostatica e bronquiale	52	OVERHOLT GEISSENDOERFER		ADSON emostatica	48
pinza p. condotto biliare	54	passafili	49	ADSON micro	35
MOELTGEN goniometro	7	periototomo doppio	128	ADSON per ipofisi	170
MOLLISON divaricatore	79	PARHAM nastro solo	118	ALEXANDER p. biopsia	292
MOORE cucchiaino p. calcoli biliari	256	tiranastro	118	ALLIS ADAIR p. intestino	259
poerforatore a mano	134	PARK blefarostato	179	ALLIS baby p. intestino	259
STAUDE pinza uterina	286	PARKER bisturi fino	14	ALLIS p. intestino	259
MOORFIELD pinza per sutura	194	divaricatore doppio, coppia	64	ARRUGA capsulare	193
motore a mano elettrico	136	PARTSCH scalpello	121	ASCH p. radizzare il setto	228
MOYNIHAN fissateli	59	sgorbia	121	pinza auricolare	204-209
pinza clamp	54	PASSOW scalpello emostatico	211	AYER per calazio	195
sonda p. calcoli biliari	257	PATON dissetto comeale	181	BABCOCK p. intestino e tessuti	259
MUCK coltello periostale	211	PAUFIQUE coltello		BAGGISH p. biopsia uterina	295
MUELLER blefarostato	179	p. cheratoplastica	181	BAINBRIDGE emostatica	53
MURDOCK blefarostato	178	pinza p. legatura	194	BALLENGER per tonsille	237
MURPHY LANE elevatorio doppio	129	TITAN pinza per legatura	194	BARRAQUER KATZIN per iride	189
MUSEUX pinza uterina	287	PAYR baby schiacciatore		BARRAQUER per camara	
MYLES pinza tagliente nasale	217	intestinale	266	anteriore	191
NABATOFF set per varici	88	schiacciatore intestinale	266	BARRAQUER Colibri per iride	189
NAEGELE forcipe	300	SCHMIEDEN sonda conduttrice	100	BARRAQUER depilatoria	197
NAGER divaricatore palatale	235	sonda conduttrice	100	BARRAQUER fissatrice	192
nastro metrico	7	PEAN pinza emostatica	47	BARRETT uterina	286
PARHAM solo	118	pinza emostatica fina	45	BEER depilatoria	197
NEFF meniscotomo	131	ROCHESTER pinza emostatica	45	BENGOLEA emostatica	48
NEGUS pinza tonsillare	236	PEDERSON specolo vaginale	276	BERKE muscolare	191
NEIVERT COTTLE divaricatore	227	PEET pinza per schegge	38	BEST intestinale	263
port'aghi	92	PELKMANN pinza per polipi	62	BEYER sgorbia	111
NELSON ago per legatura	98	PENFELD scollatore	170	pinza p. biopsia flessibile	242
pinza per dissezione	37	PENNINGTON pinza emostatica	46	pinza p. biopsia e	
trequarti per torace	90	PERCY retrattore p. amputazione	133	coagulazione flessibile	243
NORTHBENT (SPENCER)		perforatore a mano	138	pinza bipolare p.	
forbici per legatura	28	perforatore BUNNELL a mano	135	coagulazione	316-318
NOTO pinza p. polipo uterino	288	perforatore con guida telescopica	135	BLAKE p. calcoli biliari	256
NOVAK curetta		CUSHING piatto	134	BLOHMKE per tonsille	237
aspiratoria p. biopsia	290	KIRSCHNER filiforme	139	BLUMENTHAL sgorbia	109
NOYES forbici per iride	32	McKENZIE	134	BOELLER sgorbia	111
pinza p. polipi nasali	215	perforatore p. unghie	133	BONACCOLTO per strabismo	190
O'CONNOR uncino p. iris	182	periototomo, ALEXANDER	126	Bonn per iride	190,191
O'SULLIVAN O'CONNOR		COTTLE	222	Bonn TITAN per iride	191
divaricatore	83	DOYEN costale	127	BOZEMANN DOUGLAS	
OCHSNER ROCHESTER		FARABEUF	126	p. polipo uterino	63
pinza emostatica	45	JOSEPH	222	BRAUN uterina	286
sonda per calcoli biliari	256	LAMBOTTE	126	BROWN per dissezione	35
trequarti toracale	90	LANGENBECK	126	BRUENINGS tagliente nasale	215
oftalmoscopio,		MATSON	128	BRUNNER intestinale	263
MAY in astuccio metallico	2	MATSON ALEXANDER	128	BRYANT per medicazione	62

	Pagina		Pagina		Pagina
BUNT p. sterilizzazione	105	FUCHS capsulare	193	KEVORKIAN per biopsia uterina	293
BURKE p. biopsia uterina	294	GAUSS per pericranio	303	KIRBY ARTHUR p. iride	189
CASTROVIEJO capsulare	193	GELLHORN p. biopsia uterina	292	KNAPP LUER per trichiasi	195
CASTROVIEJO fissatrice	192	Gemini emostatica e passafili	49	KNIGHT tagliente nasale	215
CASTROVIEJO per sutura	194	Gemini mini		KOCHER emostatica fina	45
CHAPUT emostatica	47	emostatica e passafili	49	KOCHER intestinale	261
CHEATLE per strumenti	105	GERALD p. dissezione	37	LAHEY bronchiale	254
CHERON per polipi	62	GILL ARRUGA capsulare	192	LAHEY p. afferrare gozzo	247
CHEVALIER JACKSON	241	GILL HESS p. iride	188	LAHEY p. condotto biliare	53
CHILDE p. avvicinare		GILL p. iride	188	LAMBERT per calazio	195
i bordi della ferita	104	GILLIES p. dissezione	37	LANE per dissezione	36
COLCLOUGH ossivora	175	GLOVER vascolare Atrauma	41	LANE porta viti	144
COLLIN DUVAL	36	GRADLE depilatoria	197	LAWRENCE emostat.,p.	
COLLIN emostatica	47	GRAEFE	35	dissezione e p.legatura	52
COLLIN ombelicale	303	GRAEFE fissatrice	192	LEMPERT sgorbia	110
COLLIN per polipi	62	GRAEFE p. iride	186,187	LERCHE per dissezione	36
COLLIN tiralingua	231	GRAY p. condotto biliare	54	LERICHE emostatica	48
COLVER per tonsille	236	GREEN fissatrice	192	LESTER fissatrice	192
COOLEY Atrauma	40	GREVEN p. filo metallico	206	LISTER (sinus) p. medicazione	62
pinza corpi estranei flessibile	244	GROSS MAIER per polipi	60	LITTAUER auricolare	204
COS p. filo metallico	206	GUYON p. peduncolo renale	55	LITTAUER depilatoria	197
CRILE emostatica	45	HAJEK CLAUS		LITTAUER p. polipo nasale	215
CRILE RANKIN emostatica	45	p. seno mascellare	218	LOVE GRUENWALD	
CUSHING per dissezione	35	HAJEK KOFER ossivora	218	p. laminectomia	172
CUSHING per laminectomia	172	HALSTED micro mosquito	43	LOVELACE emostatica	46
DANDY emostatica	46	HALSTED mosquito	43	LOVELACE polmonare	254
DASTOOR per strabismo	190	HALSTED TITAN mosquito	43	LOWER p. condotto biliare	53
DAVIS p. afferrare siringhe	105	HARRINGTON bronchiale	254	LUBET BARBON p. polipo nasale	215
DEBAKEY Atrauma	40	HARTMANN auricolare	204	LUC tagliente nasale	216
DEBAKEY Bulldog Atrauma	41	HARTMANN emostatica	42	LUCAE auricolare	203
DeMARTEL WOLFSON		HARTMANN HOFFMANN		LURZ uretrale	258
p. anastomosi	264	auricolare	204	MAGILL per introdurre sonde	8
pinza depilatoria	197	HARTMANN p. polipi nasali	214	MARSCHIK tonsillare	237
DESJARDINS p. calcoli biliari	256	HARTMANN tagliente nasale	217	MARTEL p. cuoio capelluto	47
DESMARRES per calazio	195	HARTMANN WULLSTEIN		MASTIN muscolare	247
DeVILBISS craniale	169	auricolare	204	MATHIEU p. corpi estranei	269
pinza di orologio	38	HAUGH auricolare	206	MAYO BLAKE p. calcoli biliari	256
DOUGLAS depilatoria	197	HEANEY p. isterectomia	57	MAYO GUYON	
DOYEN baby intestinale	260	HEISS emostatica	48	p. peduncolo renale	55
DOYEN intestinale	260	HERRICK p. peduncolo renale	56	MAYO p. sterilizzazione	105
DOYEN p. polipo uterino	288	HESS capsulare	193	MAYO ROBSON intestinale	262
DUPLAY uterina	286	HESS p. iride	188	McCULLOUGH p. strabismo	189
DUVAL	36	HEYMANN KNIGHT nasale	215	McGEE p. filo metallico	206
DUVAL p. intestino	260	HEYMANN tagliente nasale	215	McINDOE p. dissezione	36
ELSCHNIG capsulare	193	HEYWOOD SMITH emorroidale	275	McPHERSON p. legatura	194
ELSCHNIG fissatrice	192	HOLTH p. capsuloiridectomia	185	McPHERSON TITAN p. legatura	194
EPPENDORFER		IOWA uterina	287	MEEKER emostat./p.dissez.	
p. biopsia uterina	295,296	JACKSON per tamponi	239	e p.legatura	52
FAURE p. biopsia uterina	291	JACOBS uterina	287	microchirurgica	39
FAURE p. peritoneo	56	JAMESON per strabismo	189	MICULICZ per peritoneo	56
FEHLAND intestinale	263	JANSEN nasale	214	MIDDLETON JANSEN	
FERGUSSON di pressione		JARCHO uterina	286	tagliente nasale	219
progressiva	46	JATHO faringeale tagliente	228	MILLIN p. capsula	
FERRIS SMITH KERRISON		JOHNS HOPKINS emostat.e p.		prostatica Atrauma	267
ossivora	174	condott.biliare	53	MILLIN p. capsula,	
FERRIS SMITH per dissezione	36	JUDD ALLIS p. intestino	259	retropubiana	267
FERRIS SMITH		JUERS p. filo metallico	206	MILLIN per lobuli anteriori	267
per laminectomia	173	JURASZ p. polipo laringeale	239	MILLIN portafilo	267
FINOCHIETTO bronchiale	254	KALT capsulare	193	MIXTER baby emostatica	52
FISCHER p. iride	189	KANE ombelicale	303	MIXTER p. calcoli biliari	256
pinza fissateli	59	KELLY emostatica	45	MIXTER emostat./p.dissez.	
pinza flessibile		KELLY p. polipo uterino	288	e p.legatura	53
p. gastroscopia	242-244	KELLY RANKIN emostatica	45	MIXTER emostatica e bronquiale	52
FOERSTER p. iride	188	KELLY TITAN emostatica	45	MIXTER O'SHAUGNESSY	
FOERSTER p. spugne	61	KERRISON	218	emostatica	53
FRAENKEL p. polipi laringeali	239	KEVORKIAN Pacific p.		MIXTER p. condotto biliare	54
FRIEDMAN sgorbia	109	biopsia uterina	294	pinza modello russo per dissezione	36

	Pagina		Pagina		Pagina
MOORFIELD per sutura	194	SPENCER WELLS emostatica	46	placca per osteosintesi	151,156-164
MUSEUX uterina	287	SPURLING p. laminectomia	172	placca angolare	160
MYLES tagliente nasale	217	St. MARTIN p. sutura	194	placca condilare	159
NEGUS tonsillare	236	STAUDE MOORE uterina	286	placca per dita	162-163
NELSON p. dissezione	37	STEVENS p. iride	187	JAEGER p. palpebre	179
NOTO p. polipo uterino	288	STILLE p. dissezione	34	McLAUGHLIN	149
NOYES p. polipo nasale	215	STILLE LUER sgorbia	111	SHERMAN per ossa	164
OLDBERG p. laminectomia	173	STILLE p. peduncolo renale	55	SMITH PETERSEN	149
OLIVECRONA TOENNIS		STOCKMANN per il pene	270	PLESTER coltello lobare	210
p. agrafes	166	STONE WATT intestinale	263	divaricatore	76
pinza p. dissezione	34-34	STRUEMPPEL auricolare	204	perforatore c. mandrino Jacobs	136
pinza p. posizionare		STRUYCKEN nasale	217	perforatore, HUDSON	134
clips p. aneurisma	177	pinza tagliafilii	141,142	MOORE a mano	134
pinza p. sequestri	117	TEALE uterina	287	PERTHES	138
pinza p. sterilizzazione	105	TERSON capsulare	193	RALK a mano	135
PAUFIQUE p. legatura	194	THOMS ALLIS p. intestino	259	STILLE a mano	134
PAUFIQUE TITAN p. legatura	194	THOMS GAYLOR		STILLE SHERMAN a mano	134
PEAN emostatica	47	per biopsia uterina	292	POLITZER ago per paracentesi	202
PEAN emostatica fina	45	TILLEY auricolare	204	insoffiatore aria	201
PELKMANN per polipi	62	TISCHLER KEVORKIAN		POOLE tubo p. aspirazione	8
PENNINGTON emostatica	46	p. biopsia uterina	295	port'aghi, ADSON	94
pinza per schegge	38	TISCHLER MORGAN		ARRUGA	96
PHANEUF per peritoneo	56	p. biopsia uterina	293	BARRAQUER	97
pinza piatta	141	TIVNEN per tonsille	237	BAUMGARTNER	92
POTTS SMITH p. dissezione	34	TOENNIS emostatica	50	BOYNTON	96
PRATT emostatica	47	TOWNSEND KEVORKIAN		BOZEMANN	93
PRATT uterina	287	p. biopsia uterina	294	CASTROVIEJO	97
PRICE THOMAS bronchiale	254	TOWNSEND mini p. biopsia		COLLIER	92
PRINCE muscolare	191	uterina	294,295	CRILE	94
PROVIDENCE HOSPITAL		TOWNSEND TISCHLER MORGAN		CRILE MURRAY	92
emostatica	44	p. biopsia uterina	294	CRILE WOOD	92
RADOLF p. lacerazione		TROELTSCH nasale	214	DE BAKEY	93
delle unghie	133	TROUTMAN Colibri per iride	189	DERF	92
RAMPLEY per spugne	61	TROUTMAN rectus	191	DIETHRICH	96
RANDALL p. calcolio renali	258	Tübingen TITAN p. iride	191	FINOCHIETTO	94
RANEY emostatica p.		Tübingen p. iride	191	HALSEY	92
cuoio capelluto	167	Tübingen per legatura	194	HEANEY	93
RANEY p. applicare e		TUFFIER emostatica	47	HOESEL	95
togliere pinze	167	TURREL p. biopsia rettale	275	JAMISON	93
ROBERTS emostatica	50	TYDING per tonsille	237	JOHNSON	94
ROCHESTER CARMALT		ULRICH per tamponi	60	KALT	97
emostatica	46	pinza universale p.		KALT ARRUGA	97
ROCHESTER OCHSNER		afferrare strumenti	105	MASSON	93
emostatica	45	pinza USA p. dissezione	34	MATHIEU	95
ROCHESTER PEAN emostatica	45	van DOREN p. biopsia uterina	292	MAYO HEGAR	92
ROGGE p. sterilizzazione	105	WAGNER p. laminectomia	173	MAYO HEGAR	92
ROWE disimpattante	234	WALSHAM p. raddrizzare setto	228	METZENBAUM	94
RUBIN p. ammaccare setto	217	WANGENSTEEN	37	NEIVERT	92
RUMEL toracale	50	WEIL BLAKESLEY	216	OLSEN HEGAR	95
RUSKIN sgorbia	111	WERTHEIM CULLEN		RYDER	93
SAENGER p. aborto e placenta	304	p. isterectomia	57	SAROT	94
SAROT bronchiale	255	WERTHEIM p. isterectomia	57	STEVENS	96
SATINSKY p. anastomosi	255	WHITE per tonsille	236	STRATTE	94
SAWTELL p. tonsille	236	WILDE TROELTSCH auricolare	203	TOENNIS	94
SCHNIDT p. tonsille	236	WILLET MARTEL		WANGENSTEEN	93
SCHOENBURG p. intestino	260	p. cuoio capelluto	47	YOUNG boomerang	99
SCHROEDER uterina	286,287	WILLIAMS p. intestino	260	porta-agrafes	166
SCHUBERT p. biopsia uterina	291	WINTER p. aborto e placenta	304	portacotone	89
SCHUMACHER p. biopsia		WITTNER p. biopsia uterina	293	portacotone,	89
uterina	293	WOLFF per gessi	108	FARREL	89
SCHWEIGGER capsulare	193	YEOMAN p. biopsia rettale	275	JOBSON HORNE	89
SEMB bronchiale	255	YOUNG p. afferrare la prostata	267	TOBOLD laringeale	89
SEMKEN p. dissezione	37	YOUNG tirlingua	231	UCKERMANN	89
pinza serratubi	58	ZAUFAL JANSEN sgorbia	111	portapinze,	
SINGLEY	37	ZENKER emostatica e passafilii	51	DeMARTEL WOLFSON	264
SKENE uterina	286	PIPER forcipe	302	POTTS DE MARTEL	
SNELLEN p. entropio	195	PITHA apribocca di silicio	234	forbici vascolari	23,24

Pagina	Pagina	Pagina
SMITH forbici vascolari ..... 24	ROGGE pinza p. sterilizzazione ... 105	WEST nasale ..... 224
SMITH pinza per dissezione ..... 34	ROLLET divaricatore ..... 182	scatola in vetro p. strumenti .. 308,309
PRATT pinza emostatica ..... 47	scalpello p. sacco lacrimale ..... 182	scatola in acciaio p. strumenti .... 308
pinza uterina ..... 287	rompe-lamette CASTROVIEJO .... 13	scatola per aghi da sutura ..... 308
specolo rettale ..... 272	TROUTMAN CHRIS ..... 13	SCHAEDEL fissateli ..... 59
unicino cistico ..... 274	rondelle p. vite p.	SCHAMBERG tiracomedoni ..... 306
PRICE THOMAS pinza bronchiale . 254	osteosintesi ..... 152,153,155	SCHAEDE curetta tagliente ..... 119
PRINCE forbici per tonsille ..... 23	ROSE uncino tracheale doppio ... 246	schegge, ARCHER pinza per ..... 38
pinza muscolare ..... 191	ROSEN aghi ..... 210,211	CARMALT pinza per ..... 38
proctoscopio, KELLY ..... 274	coltello circolare ..... 210	FEILCHENFELD pinza per ..... 38
protettore di tessuto	ROSENBERG punta di	HUNTER pinza per ..... 38
p. vite cannulate ..... 145	pinza laringeale ..... 240	PEET pinza per ..... 38
PROVIDENCE HOSPITAL	ROSER KOENIG apribocca ..... 231	pinze per ..... 38
pinza emostatica ..... 44	ROUX baby divaricatore ..... 64	STIEGLITZ pinza per ..... 38
pudendus, ago p. anestesia ..... 91	divaricatore ..... 64	VIRTUS (RALK) pinza per ..... 38
punzone, KUENTSCHER	mini divaricatore ..... 64	SCHIEIE cannula oftalmologica ... 196
midollare ..... 143	ROWE pinza p. mascella ..... 234	coltello per goniotomia ..... 181
PUTTI lima per ossa ..... 132	RUBIN pinza p. ammaccare	SCH EINMANN punta di
QUINBY forbici per guance ..... 29	il setto ..... 217	pinza laringeale ..... 240
QUIRE leva p. corpi estranei .... 204	RUMEL pinza toracale ..... 50	schiacciatore intestinale
QUISLING martello intranasale ... 125	RUSKIN LISTON cesoia p. ossa .. 113	PAYR baby ..... 266
rachiotomo ..... 124	pinza sgorbia ..... 111	intestinale PAYR ..... 266
RADOLF pinza p. lacerazione	STILLE pinza sgorbia ..... 112	SCHIMMELBUSCH tamburo
di unghie ..... 133	RYDEL SEIFFER diapason ..... 200	p. sterilizzazione ..... 311
RALK perforatore a mano ..... 135	RYDER port' aghi ..... 93	SCHINK dermatomo ..... 15
RAMPLEY pinza per spugne ..... 61	SAALFELD tiracomedoni ..... 306	SCHIOETZ tonometro ..... 197
RANDALL curetta aspirante	SACHS dissettore p. duramadre .. 169	SCHMIEDEN PAYR sonda
per biopsia ..... 290	divaricatore p. nervi ..... 168	conduttrice ..... 100
pinza per calcoli renali ..... 258	SAENGER pinza p. aborto	sonda conduttrice ..... 100
RANEY pinza emostatica	e placenta ..... 304	TAYLOR forbici p. duramadre ... 27
p. cuoio capelluto ..... 167	salpingografo, SCHULTZE ..... 297	SCHNIDT pinza p. tonsille ..... 236
pinza p. appl. e togliere le pinze . 167	SANVENERO forbici ..... 21	SCHOENBORN divaricatore
rasoio ..... 16	SAROT pinza bronchiale ..... 255	p. tiroide ..... 247
rasoio, lamette per microchirurgia .. 13	pinza clamp bronchiale ..... 51	SCHOENBURG pinza p. tessuti ... 260
raspa, AUFRICHT nasale ..... 224	port' aghi ..... 94	SCHROEDER pinza uterina .. 286,287
FOMON nasale ..... 225,226	SATINSKY forbici toracali ..... 27	SCHUBERT pinza p.
GALLAHER per seno	pinza p. anastomosi ..... 255	biopsia uterina ..... 291
mascellare ..... 226	SATO coltello corneale ..... 181	SCHUKNECHT coltello circolare .. 210
JOSEPH (LEWIS) nasale ..... 225	SATTERLEE sega da amputazione . 133	coltello falciforme ..... 210
MALTZ (COTTLE) nasale ..... 225	SAUERBRUCH costotomo ..... 249	SCHULTZE salpingografo ..... 297
WIENER (AUFRICHT) nasale ... 225	divaricatore ..... 75	SCHUMACHER forbici ombelicali .. 26
WIENER per il seno mascellare . 225	FREY costotomo ..... 249	pinza p. biopsia uterina ..... 293
RECAMIER curetta uterina ..... 299	pinza sgorbia ..... 112	punta di pinza laringeale ..... 240
recipiente cilindrico ..... 310	scatola p. aghi da sutura ..... 308	SCHWEIGGER pinza capsulare ... 193
regoli ..... 7	SAWTELL pinza p. tonsille ..... 236	sclerotomo,
REICHERT depressore	SCAGLIETTI pinza sgorbia ..... 112	GUYTON LUNDGAARD ..... 181
per epiglottis ..... 239	scalpelli ..... 121-123	LUNDGAARD ..... 181
REINER coltello p. gesso ..... 108	scalpello, ALEXANDER ..... 121	scollatendini, BUNNELL ..... 132
siringa auricolare ..... 201	BRUNETTI spinale ..... 124	scollatore, FISCH ..... 211
rettoscopio, STRAUSS ..... 273	CINELLI p. plastica ..... 223	HORSLEY p. duramadre ..... 170
REVERDIN ago per legatura ..... 99	COTTLE p. plastica ..... 223	PENFIELD ..... 170
divaricatore addominale ..... 66	DIX, ed ago ..... 185	SEDILLOT periostotomo ..... 126
REYNOLDS forbici ..... 21	DIX p. corpi estranei ..... 182	SEEMANN SEIFFERT apribocca .. 232
RIBBON divaricatore ..... 66	FOMON ..... 223	sega, BERGMANN per gessi ..... 106
RICHARDSON divaricatore ..... 66	FREER per il setto ..... 222	CHARRIERE da amputazione .. 133
EASTMAN divaricatore ..... 66	HOBBS ..... 123	sega circolare ..... 138
RICHTER HEATH pinza p. agrafes . 104	HOKS ..... 123	De MARTEL guida ..... 169
riflettore di ricambio solo ..... 4	LEBSCHKE per lo sterno ..... 124	sega elettrica p. gessi ..... 107
RIGBY divaricatore	LEXER ..... 123	ENGEL per gessi ..... 106
rettale e vaginale ..... 86	LEXER mini ..... 123	GIGLI manico per ..... 169
ROBERTS pinza emostatica ..... 50	PARTSCH ..... 121	JOSEPH nasale ..... 227
ROCHESTER CARMALT	PASSOW emostatico ..... 211	LANGENBECK a dito ..... 133
pinza emostatica ..... 46	ROLLET p. sacco lacrimale .... 182	OLIVECRONA filo metallico ... 169
OCHSNER pinza emostatica .... 45	SILVER p. plastica ..... 224	sega per anelli forma tenaglia ... 133
PEAN pinza emostatica ..... 45	SMITH PETERSEN ..... 122	SATTERLEE da amputazione ... 133
ROEDER fissateli ..... 59	STILLE ..... 121	WIGMORE per gessi ..... 106
ROGER elevatorio per setto ..... 221		SEGOND bisturi per fibromi ..... 296

	Pagina		Pagina		Pagina
SEIFFERT punta di pinza		SMITH PETERSEN	122	KOENIG conduttrice	100
laringeale	240	STILLE	121	MAYO per calcoli renali	258
SEEMANN apribocca	232	STILLE LUER pinza	111	sonda metall. p. donne	271
SELLHEIM cucchiaio ostetrico	305	STILLE RUSKIN pinza	112	sonda metall. p. uomini	271
SEMB cesoia per ossa	114	WALTON p. corpi estranei	182	MOYNIHAN p. calcoli biliari	257
periostotomo costale	127	WEST nasale	224	OCHSNER p. calcoli biliari	256
pinza bronchiale	255	SHEA forbici micro auricolari	205	PAYR conduttrice	100
pinza sgorbia	113	SHERMAN placca per ossa	164	sonda per misurare	211
tenaglia per ossa	114	STILLE perforatore a mano	134	SCHMIEDEN conduttrice	100
SEMKEN pinza per dissezione	37	vite per ossa	164	SCHMIEDEN PAYR conduttrice	100
SEMM specolo vaginale	277	SIEBOLD forbici	25	STACKE auricolare	88
SENN divaricatore	66	SIEGLE specolo auricolare		spatola, ALLISON, polmonare	253
GREEN divaricatore	69	pneumatico	198	spatola, BANGERTER	
sequestri, pinza per	117	SILVER scalpello p. plastica	224	p. ciclodialisi	184
VAN BUREN pinza per	117	SIMCOE cannula per sutura	196	CASTROVIEJO p.,	
serrafina, DIEFFENBACH	42	SIMON cucchiaio uterino		ciclodialisi	184,185
JOHNS HOPKINS	42	tagliante	297	CULLER, per iride	184
serranodi, BRUENINGS tonsillare	237	curetta tagliante	120	CUSHING cerebrale	171
EVES tonsillare	237	divaricatore	74	ELSCHNIG, p. ciclodialisi	184
KRAUSE nasale	219	SIMPSON BRAUN forcipe	300	HEIFETZ cerebrale	171
KRAUSE auricolare	203	forcipe	300	KOCHER, vescicale	268
TYDING tonsillare	238	LUIKART forcipe	301	LEGUEU, vescicale	268
WESTON p. polipi rettali	275	SIMS curetta uterina	299	OLIVECRONA cerebrale	171
WILDE auricolare	203	depressore uterino	289	WECKER p. iride	184
WILDE nasale	219	dilatatore uterino	285	WELLS p. enucleazione	184
serrapinze,		forbici per utero	25	WHEELER p. ciclodialisi	185
DeMARTEL WOLFSON	264	isterometro	289	specchio laringeale	241
STONE	263	specolo vaginale	281	specchio, MICHEL, faringeale	214
serratubi, pinze	58	specolo rettale	272	ZIEGLER frontale	4
serratura, STONE WATT sola	263	SINGLEY pinza	37	specillo bottonuto con occhio	88
set, BAKES di sonde biliari	257	siringa, MENGHINI p. aspirazione	91	specillo bottonuto	88
set di seghe, perforatori e frese	138	REINER auricolare	201	specillo, BOWMAN lacrimale	186
set di strumenti per autopsia	124	siringa tonsillare	238	DOYEN scanalato	88
divaricatore per muscoli	87	SKENE pinza uterina	286	specillo foglia mirte	88
NABATOFF per varici	88	SLUDER BALLENGER		specillo scanalato	88
set per diagnostica	3	tonsillotomo	238	specillo scanalato bottonuto	88
set per manicure p. infermiere	307	SMELLIE spezzacrani	305	specolo, ALAN PARKS rettale	273
set per otoscopia	3	uncino ostetrico	303	AUVARD vaginale	282
set per sutura con agrafes	105	SMILLIE meniscotomo	131	BARR rettale	272
set per tracheotomia in astuccio	246	SMITH blefarostato	178	BODENHAMMER rettale	272
trequarti univernale addominale	90	BUIE divaricatore rettale	273	BOUCHERON auricolare	198
SEXTON coltello auricolare	202	FERRIS pinza per dissezione	36	BREISKY vaginale	282
sfigmomanometri	1	FERRIS pinza per laminectomia	173	BRUENINGS auricolare	
sgorbie	121-123,224	HEYWOOD pinza emorroidale	275	pneumatico	198
sgorbia, ADSON pinza	110	PETERSEN chiodo per		CASPAR lomb. vertebrale	82
ALEXANDER	121	collo di femore	149	COLLIN vaginale	276
BLUMENTHAL pinza	109	PETERSEN placca per collo		COTTLE nasale	213
CLEVELAND pinza	109	di femore	149	CUSCO vaginale	276,277
DIX ed ago	185	PETERSEN scalpello	122	CZERNY rettale	272
ECHLIN pinza	112	PETERSEN sgorbia	122	DOYEN vaginale	281
ELLIS p. corpi estranei	182	POTTS forbici vascolari	24	GRAVE vaginale	276
FREER	224	POTTS pinza per dissezione	34	GRUBER auricolare	198
FRIEDMAN pinza	109	US Army forbici p. garza	29	HARTMANN auricolare	198
HAJEK forma V	224	SMITHWICK divaricatore p. nervi	168	HARTMANN HALLE nasale	212
HIBBS	123	pinza p. applicare agrafes	166	JACKSON vaginale	281
KILLIAN CLAUS forma V	224	SNELLEN ansa	184	KALLMORGEN vaginale	280
LEKSELL (STILLE) pinza	112	pinza p. entropio	195	KILLIAN per setto	213
LEXER	123	SOMER pinza isterolabo	288	KRIESTELLER vaginale	278-280
LEXER mini	123	sonda, BAKES p. calcoli biliari	257	LANDAU vaginale	282
LUER pinza	110	BRUNNER conduttrice	100	MATHIEU rettale	272
MEAD pinza	109	COXETER prostatica	271	PEDERSON vaginale	276
OLIVECRONA pinza	110	DESJARDINS p. calcoli biliari	257	PRATT rettale	272
PARTSCH	121	forbici p. enterotomia	28	SEMM vaginale	277
RUSKIN pinza	111	HARTMANN auricolare	202	SIEGLE auricolare pneumatico	198
SAUERBRUCH pinza	112	ITARD auricolare	202	SIMS vaginale	281
SCAGLIETTI pinza	112	KIRSCHNER conduttrice	100	SIMS rettale	272
SEMB pinza	113	KOCHER per gozzo	247	THUDICHUM nasale	212



	Pagina		Pagina		Pagina
TIECK HALLE nasale	213	pinza articolazione doppia	142	OLIVECRONA pinza p. agrafes	166
TOYNBEE auricolare	198	pinza e per piegare	141	pinza emostatica	50
TRELAT vaginale	277	taglialegature	244	port'aghi	94
Vienna mod. nasale	212	tamburo, KONRICH filtro,		tonometro, SCHIOETZ	197
VOLTOLINI nasale	212	p. sterilizzare	311	tonsillotomo,	
YANKAUER per faringe	214	SCHIMMELBUSCH p.		SLUDER BALLENGER	238
SPENCER forbici per legature	28	sterilizzare	311	TOOK coltello corneale	181
WELLS pinza emostatica	46	TARNIER cranioclasto	305	TOTI fresa	137
spezzacrani, SMELLIE	305	forcipe	302	TOWNSEND KEVORKIAN	
spiedo di guida centromidollare	143	TAYLOR divaricatore p. la spina	131	pinza p.biopsia uterina	294
SPRATT curretta tagliente	119	martello	6	mini pinza p.biopsia uterina	295
SPURLING pinza per		SCHMIEDEN forbici duramadre	27	mini punta p.pinza	
laminectomia	172	TEALE pinza uterina	287	p.biopsia uterina	294
St. MARTIN pinza p. sutura	194	tenaglia, BIRCHER GANSKE		pinza taglio mini	
STACKE sonda auricolare	88	p. ossa	117	p.biopsia uterina	294
STAUDE MOORE pinza uterina	286	DINGMANN per ossa	117	pinza taglio ovale	
StCLAIR THOMSON coltello	229	FARABEUF LAMBOTTE p. ossa	115	p.biopsia uterina	294
STEINMANN chiodo p. ossa	139	FARABEUF per ossa	114	TISCHLER MORGAN pinza	
STERNBERG divaricatore		FERGUSSON per ossa	114	p.biopsia uterina	294
di labbra	230	KERN per ossa	115	TOYNBEE specolo auricolare	198
stetoscopio, BOWLES	5	LAMBERT LOWMAN p. ossa	118	trapani, ELLIOT	197
Duplex	5	LAMBOTTE per ossa	115	KEYES cutanei	306
FORD	5	LANE per ossa	115	per ossa	134,137,138
FORD BOWLES	5	LANGENBECK per ossa	114	trapano cannulato	
STEVENS forbici p. tenotomia	22	LEWIN per ossa	117	p.viti cannulate	145
pinza p. iride	187	LOWMAN p. ossa	118	trapano, CASTROVIEJO	196
port'aghi	96	MARTIN p. cartilagini	117	FRANCESCHETTI	
uncino per cristallino	182	tenaglie per ossa	114-118	p.cheratomia	196
STEVENS pinza blefarostato	179	tenaglia piatta	141	trattore, BARTON, p. forcipi	301
STIEGLITZ pinza per schegge	38	SEMB per ossa	114	LUIKART BILL, p. forcipi	302
STILLE costotomo	248	VERBRUGGE per ossa	116	TRAUBE martello	6
forbici per gessi	106	tendifilii KIRSCHNER	140	trazione, CRUTCHFIELD craniale	167
GIERTZ costotomo	249	tenddfilo LOUTE	141	trefina, KEYES	306
HAGLUND divaricatore p. gessi	108	TERSON pinza capsulare	193	TRELAT specolo vaginale	277
HORSLEY cesoia p. ossa	114	THOMAS PRICE pinza bronchiale	254	trequarti addominale	90
LISTON cesoia p. ossa	113	THOMS ALLIS pinza		trequarti, COAKLEY	
LUER pinza sgorbia	111	p.intestini e tessuti	259	p. seno mascellare	90
MAYO forbici	19	GAYLOR pinza per biopsia	292	DOUGLAS e cannula	90
osteotomo	121	THOMSON StCLAIR coltello	229	FLEURANT p. vescica	90
pinza per dissezione	34	WALKER divaricatore vescicale	268	LICHTWITZ seno	
pinza p. peduncolo renale	55	THOREK forbici pulmonari (toracali)	27	p. seno mascellare	90
poerforatore a mano	134	THUDICHUM specolo nasale	212	NELSON toracale	90
RUSKIN pinza sgorbia	112	TIECK HALLE specolo nasale	213	OCHSNER toracale	90
scalpello	121	TILLEY pinza auricolare	204	UCKERMANN	245
sgorbia	121	tlracomedoni, SAALFELD	306	TROELTSCHE pinza nasale	214
SHERMAN perforatore a mano	134	SCHAMBERG	306	WILDE pinza auricolare	203
STOCKMANN pinza per il pene	270	UNNA	306	TROEMNER martello	6
STONE serrapinze	263	WALTON	306	tronchesina per pelle	307
WATT pinza intestinale	263	tiramioni, DOYEN	296	tronchesina per unghie	307
WATT serratura sola	263	tiranastro, PARHAM	118	tronchesina, TURNBULL p. unghie	307
STRATTE port'aghi	94	tiravene	89	TROUSSEAU dilatatore tracheale	245
STRAUSS pinza per il pene	270	TISCHLER KEVORKIAN		TROUTMAN CHRIS rompe lamette	13
rettoscopio	273	pinza p. biopsia uterina	295	Colibri pinza p. iride	189
STRUEMPPEL pinza auricolare	204	KEVORKIAN punta p. pinza		pinza p. il rectus	191
STRULLY forbici neurochirurgiche	26	p. biopsia	294	tubo, ADSON di aspirazione	171
strumento, bacinella per	310	MORGAN pinza p. biopsia		BUIE di aspirazione	275
strumento p.conficcare		uterina	293	FRAZIER di aspirazione	171
e chiavare chiodi	142	MORGAN punta p. pinza		FRAZIER di punzione.d	171
LAFORCE p. corpi estranei	182	p. biopsia	294,296	JACKSON tracheale	246
LLOYD p.conficcare		TOWNSEND MORGAN pinza		LUER tracheale	246
e chiavare chiodi	144	p. biopsia uterina	294	POOLE di aspirazione	8
vassoio per	310	TIVNEN pinza per tonsille	237	WAGENER MOSHER	246
STRUYCKEN pinza nasale	217	TOBOLD abassalingua	230	YANKAUER di aspirazione	8
SWEET pinza p. applic. agrafes	166	portacotone laringeale	89	Tübingen TITAN pinza p. iride	191
TABB coltello falciforme	210	TOENNIS ADSON forbici		Tübingen cannula per aria	196
tagliacalli, Credo	307	neurochirurgici	26	Tübingen pinza per legatura	194
tagliafilii, Diamant	142	dissettore p. duramadre	169	TUFFIER divaricatore	252

	Pagina		Pagina		Pagina
pinza emostatica	47	vite malleolare	154	WINTER pinza p. aborto	
TURNBULL tronchesina p. unghie	307	SHERMAN p. ossa	164	e placenta	304
TURREL pinza per biopsia rettale	275	vite p. la spongiosa	152,153,155	WITTNER pinza p. biopsia uterina	293
TYDING pinza per tonsille	237	VOLKMANN curetta tagliente	119,120	WOLFF pinza per gessi	108
serranodi per tonsille	238	divaricatore	69,70	WOOD CRILE port'aghi	92
UCKERMANN portacotone	89	VOLTOLINI specolo nasale	212	WRIGLEY forcipe	300
trequarti	245	vPETZ apparecchio		WULLSTEIN coltello falciforme	210
ULRICH pinza per tamponi	60	p. sutura intestinale	266	forbici p. microchirurgia	207
uncinetto	211	WACHENFELDT agrafes	104	HARTMANN pinza auricolare	204
uncinetto, BARBARA	210	pinza per agrafes	104	WEITLANER divaricatore	76
GILLIES fino	227	WADSWORTH TODD cauterio	184	WYLIE dilatatore uterino	285
GRAEFE (iris)	68	WAGENER MOSHER		YANKAUER specolo per faringe	214
GUTHRIE doppio	68	tubo salvavita	246	tubo p. aspirazione	8
KILNER p. pelle	306	uncinetto bottonuto	203	YASARGIL	
McGEE	211	WAGNER forbici	29	clips p. aneurisma	176,177
WAGENER bottonuto	203	pinza p. laminectomia	173	YEOMAN pinza p. biopsia rettale	275
uncino, ARRUGA p. estrazione	182	WALLICH cucchiaino p. aborto	304	YOUNG ago di ricambio	99
BOSE tracheale	245	WALSHAM pinza		boomerang port'aghi	99
BRAUN p. decapitazione	305	raddrizzare il setto	228	divaricatore prostatico	267
CASPAR	81	WALTON sgorbia p. corpi estranei	182	pinza p. afferrare prostata	267
uncino cava chiodi	143	tiracomedoni	306	pinza tiralingua	231
DANDY per nervi	168	WANGENSTEEN pinza	37	ZAUFAL JANSEN pinza sgorbia	111
DAY auricolare	203	port'aghi	93	ZENKER pinza p. dissez. e passafili	51
EMMET p. fistola	296	WARTENBERG sensimetro	7	ZIEGLER blefarostato	179
GRAEFE p. strabismo	182	WATSON CHEYNE elevatore	129	coltello p. capsulotomia	181
GRAEFE TITAN p. strabismo	182	WEBER ansa	184	coltello p. iridectomia	180
GREEN muscolare	182	WECKER forbici per iride	32	dilatatore lacrimale	186
GROSS, e curetta	202	spatola per iride	184	specchio frontale	4
ITERTSON tracheale	245	WEEK blefarostato	178		
JACKSON tracheale	245	WEIL BLAKESLEY pinza nasale	216		
JAMESON per strabismo	182	WEITLANER divaricatore	76		
JOSEPH per mucosa	68	WULLSTEIN divaricatore	76		
uncino per estensione	140	WELLS spatola p. enucleazione	184		
ROSE tracheale doppio	246	SPENCER pinza emostatica	46		
SMELLIE ostetrico	303	WERTHEIM CULLEN			
STEVENS per cristallino	182	pinza p. isterectomia	57		
universal forbici p. filo metallico	29	forbici p. dissezione	25		
UNNA tiracomedoni	306	pinza p. isterectomia	57		
uretrotomo, MAISONNEUVE	269	WEST scalpello nasale	224		
US Army divaricatore doppio	65	sgorbias nasale	224		
SMITH Army forbici p. garza	29	WESTCOTT forbici p. iridectomia	39		
vacuometro p. vuoti di sangue	132	forbici p. tendini	32		
valva, BALFOUR centrale	84	WESTON serranodi p. polipi rettali	275		
CASPAR laterale	80	WHEELER coltello p. diszissione	180		
CASPAR mediale	80	spatola p. ciclodialisi	185		
CASPAR smussa	80	WHITE pinza per tonsille	236		
CASPAR sola	82	WHITEHEAD apribocca	232		
CLOWARD	79	WIEDER abassalingua	230		
KALLMORGEN vaginale	280	WIENER (AUFRICHT)			
KRISTELLER vaginale	278,279	raspa nasale	225		
VAN BUREN pinza p. sequestri	117	raspa per il seno mascellare	225		
van DOREN pinza p.		uncino per iris	182		
biopsia uterina	292	WIGMORE sega per gessi	106		
VANNAS forbici per iridectomia	33	WILDE serranodi auricolare	203		
vassoio p. strumenti	310	serranodi nasale	219		
vBUREN candeletta dilatatrice	271	TROELTSCH pinza auricolare	203		
VERBRUGGE tenaglia per ossa	116	WILDER ansa	184		
VERRES ago per		dilatatore lacrimale	186		
pneumoperitoneo	91	WILLET MARTEL pinza			
Vienna mod. specolo nasale	212	p. cuoio capelluto	47		
VIRCHOW coltello p. cartilagini	16	WILLIAMS blefarostato	178		
divisore craniale	124	giraviti/portaviti	144		
VIRTUS (RALK) pinza p. schegge	38	pinza p. intestini			
vite cannulate p. osteosintesi	152	e tessuti	260		
vite corticali	152-154	WILLIGER curetta doppia	120		
vite da compressione	151	martello	125		
vite p. il femore, dinamica	151	periostotomo	126		

**HERMANN**  
MEDIZINTECHNIK



Hermann Medizintechnik GmbH  
Württembergische Straße 26  
D-78567 Fridingen / Tuttlingen  
GERMANY  
Tel. +49-74 63 / 99 67-0  
Fax +49-74 63 / 99 67-50  
info@hermann-medizintechnik.de  
www.hermann-medizintechnik.de

