



Arthroscopy

HERMANN
MEDIZINTECHNIK

**Ultimate precision
for our arthroscopic
instruments**

Arthroscopy



Since more than 50 years:

Quality and Safety

Know How and Innovation
Technology and Precision
Service and Flexibility

Quality Management:

Certified according to: ISO 13485;
Annex II, section 3 of the directive
93/42/EEC

Our Products:

Instruments for MIS (Laparoscopy,
Hysteroscopy, Arthroscopy, Urology)

Endoscopy units

Electrosurgery and accessories

Plastic surgery

Titanium-implant-systems for maxillo-
facial as well as hand- and radius
surgery, mandibular reconstruction

Scissors and micro-scissors, also with
TC-inserts or "super cut"

Instruments for general surgery

Inhaltsverzeichnis

Arthroskope	Seite	22
Arthroskopieelektroden		23
Breitmaulstanzen		8,9
Faß-PE Zange		10,11,13
Hand-Instrumente		14-16
Interferenzschrauben		17
Lichtleitkabel		22
Saugstanze		12
Scheren		6-8,10,11
Spülkanüle		20
Stanzen		6-11
Trokar/Obturator		19,21
Trokarhülsen		18, 21

Index

<i>Arthroscopes</i>	<i>Page</i>	22
<i>Arthroscopic Electrodes</i>		23
<i>Big Bite Basket Punches</i>		8,9
<i>Grasping / Biopys Forceps</i>		10,11,13
<i>Hand Instruments</i>		14-16
<i>Interference Screws</i>		17
<i>Light Cables</i>		22
<i>Punches</i>		6-11
<i>Scissors</i>		6-8,10,11
<i>Suction/Irrigation Tubes</i>		20
<i>Suction-Punch</i>		12
<i>Trocar / Obturators</i>		19,21
<i>Trocar Sleeves</i>		18,21

Technische Änderungen
vorbehalten.

*We reserve the right
to make alterations.*



Griffmodelle Handles

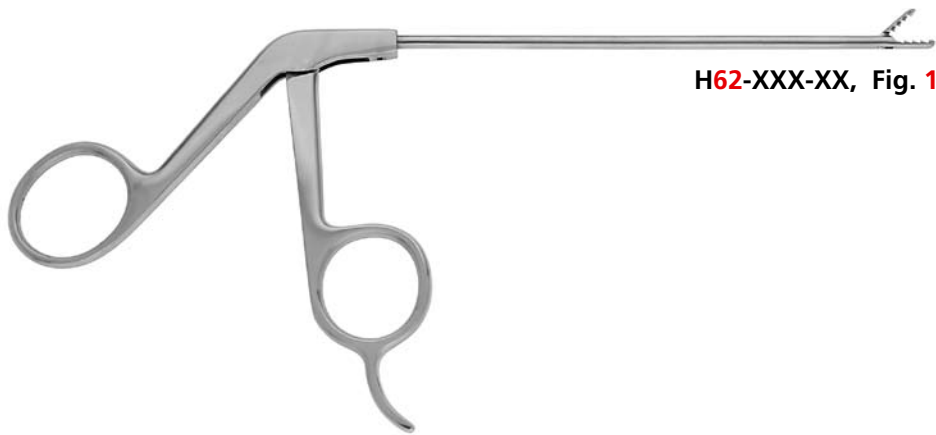

H62-XXX-XX, Fig. 1

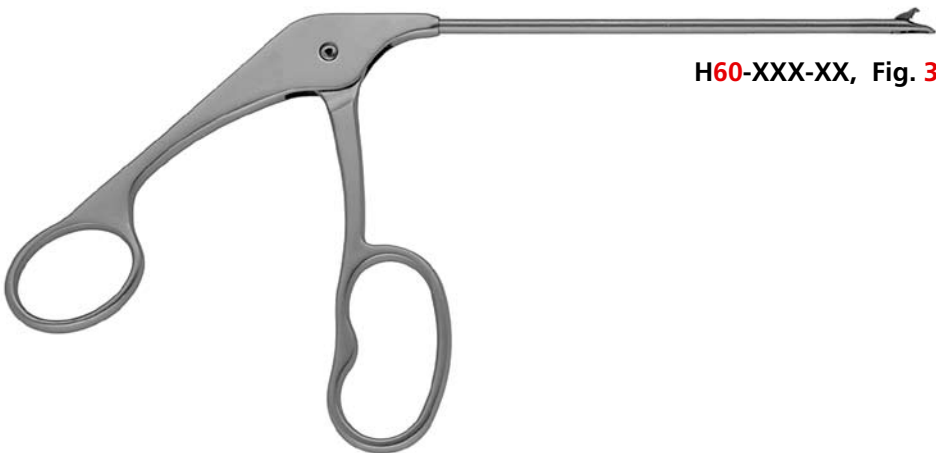

H60-XXX-XX, Fig. 3

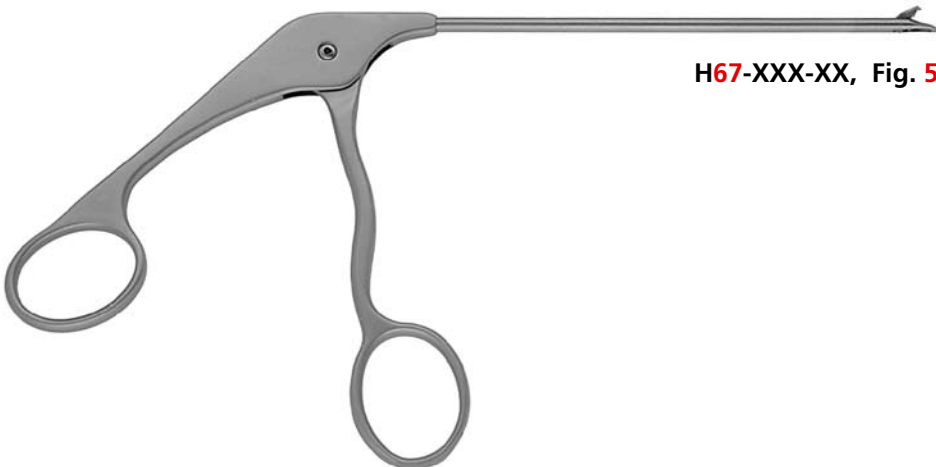

H67-XXX-XX, Fig. 5

Aufbau Artikelnummern:
Bei unseren neuen Arthroskopiestanzen gibt es verschiedene Griffmodelle, wie hier abgebildet. Auf den folgenden Seiten können Sie in der Übersicht jeweils die verschiedenen Griffmodelle ersehen, die für die entsprechenden Ausführungen geliefert werden können.

Bitte einfach die Artikelnummer des gewünschten Griffmodells angeben und die Nummer der Stanze anhängen.

Beispiel:
Hakenschere gerade 2,7mm,
Griff Fig. 1 H62-271-10
Hakenschere gerade 2,7mm,
Griff Fig. 6 H68-271-10

Different handles are available for our new Arthroscopy punches. You can see the different types of handles on the following pages.

Please just mention the item number of the required handle and attach the reference number of the punch.

Example:

*Hook scissors, straight 2,7mm,
Handle Fig. 1 H62-271-10*

*Hook scissors, straight 2,7mm,
Handle Fig. 6 H68-271-10*

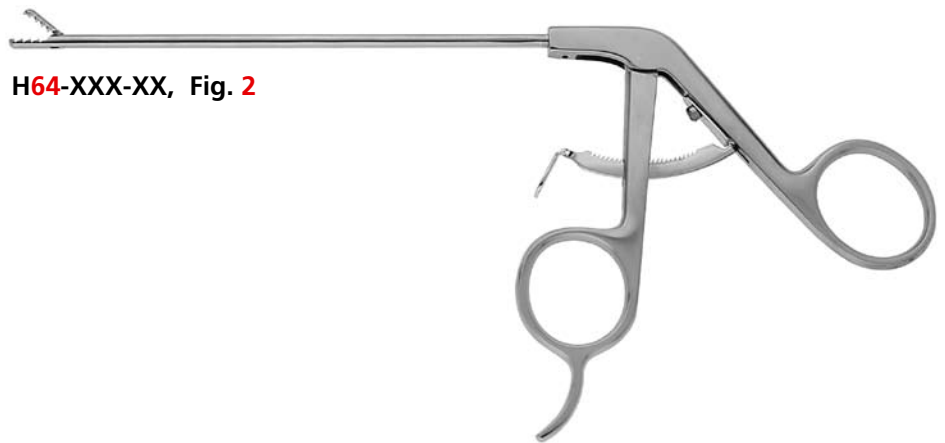

H64-XXX-XX, Fig. 2

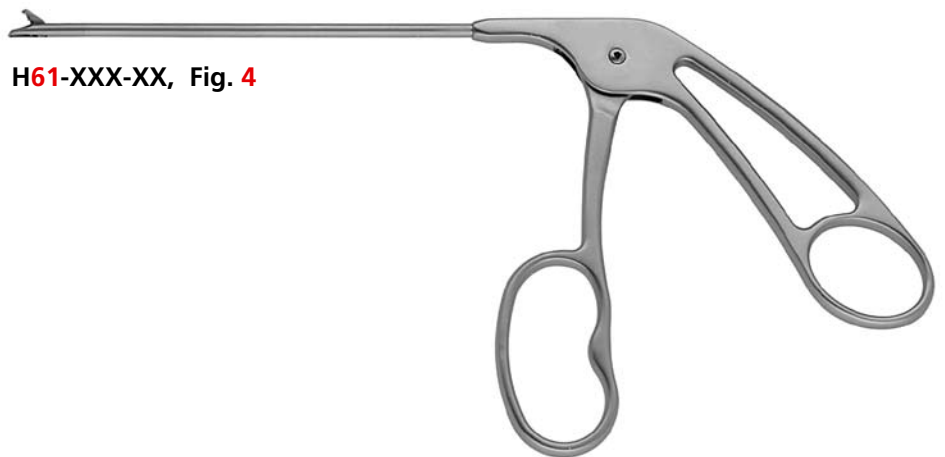

H61-XXX-XX, Fig. 4



H68-XXX-XX, Fig. 6

H62-XXX-XX
Fig. 1

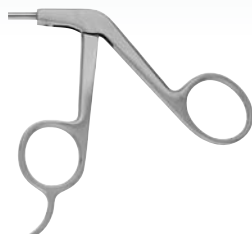

H60-XXX-XX
Fig. 3



H61-XXX-XX
Fig. 4















Hakenschere
Hook Scissors

Hakenstanze mit Schaufel
Hook Punch with Scoop

Hakenstanze abgesetzt,
stumpf
*Hook Punch set down,
blunt*

Hakenstanze, Schnitt eckig
Hook Punch, Cut angular





	Ø mm	Stanzung Bite mm	gerade straight	30° rechts 30° right	30° links 30° left
	2,7	-	HXX-271-10	HXX-272-10	HXX-273-10
	3,5	-	HXX-351-10	HXX-352-10	HXX-353-10
	2,7	5,0 X 1,6	HXX-271-21	HXX-272-21	HXX-273-21
	3,5	5,0 X 1,6	HXX-351-21	HXX-352-21	HXX-353-21
	2,7	5,0 X 1,6	HXX-271-23	HXX-272-23	HXX-273-23
	3,5	5,0 X 1,6	HXX-351-23	HXX-352-23	HXX-353-23
	2,7	5,0 X 1,6	HXX-271-25	HXX-272-25	HXX-273-25
	3,5	5,0 X 1,6	HXX-351-25	HXX-352-25	HXX-353-25
	2,7	5,0 X 1,6	HXX-271-27	HXX-272-27	HXX-273-27
	3,5	5,0 X 1,6	HXX-351-27	HXX-352-27	HXX-353-27
	2,7	5,0 X 1,6	HXX-271-29	HXX-272-29	HXX-273-29
	3,5	5,0 X 1,6	HXX-351-29	HXX-352-29	HXX-353-29

Hakenstanze, 15° aufwärts
gefräst
Hook Punch, 15° up milled

Breitmaulstanze groß
Wide Jaw Punch large

Breitmaulstanze mittel
Wide Jaw Punch medium

Breitmaulstanze klein
Wide Jaw Punch small

	Ø mm	Stanzung Bite mm	gerade straight	30° rechts 30° right	30° links 30° left
	2,7	5,0 X 1,6	HXX-271-36	HXX-272-36	HXX-273-36
	3,5	5,0 X 1,6	HXX-351-36	HXX-352-36	HXX-353-36
	3,5	5,0 X 4,5	HXX-351-38	HXX-352-38	HXX-353-38
	3,5	5,0 X 3,5	HXX-351-37	HXX-352-37	HXX-353-37
	3,5	6,0 X 2,5	HXX-351-39	HXX-352-39	HXX-353-39

H67-XXX-XX
Fig. 5



H68-XXX-XX
Fig. 6

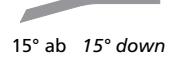
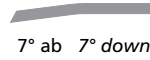
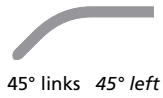
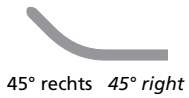

HXX-274-10
HXX-354-10

HXX-275-10
HXX-355-10

HXX-276-10
HXX-356-10

HXX-277-10
HXX-357-10

HXX-278-10
HXX-358-10

HXX-279-10
HXX-359-10

HXX-274-21
HXX-354-21

HXX-275-21
HXX-355-21

HXX-276-21
HXX-356-21

HXX-277-21
HXX-357-21

HXX-278-21
HXX-358-21

HXX-279-21
HXX-359-21

HXX-274-23
HXX-354-23

HXX-275-23
HXX-355-23

HXX-276-23
HXX-356-23

HXX-277-23
HXX-357-23

HXX-278-23
HXX-358-23

HXX-279-23
HXX-359-23

HXX-354-24

HXX-355-24

HXX-356-24

HXX-357-24

HXX-358-24

HXX-359-24

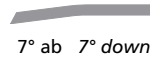
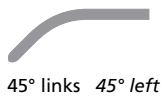
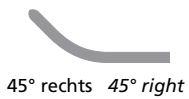

HXX-274-36
HXX-354-36

HXX-275-36
HXX-355-36

HXX-276-36
HXX-356-36

HXX-277-36
HXX-357-36

HXX-278-36
HXX-358-36

HXX-279-36
HXX-359-36

HXX-354-38

HXX-355-38

HXX-356-38

HXX-357-38

HXX-358-38

HXX-359-38

HXX-354-37

HXX-355-37

HXX-356-37

HXX-357-37

HXX-358-37

HXX-359-37

HXX-354-39

HXX-355-39

HXX-356-39

HXX-357-39

HXX-358-39

HXX-359-39

H62-XXX-XX
Fig. 1



H60-XXX-XX
Fig. 3



H61-XXX-XX
Fig. 4



Breitmaulstanze groß
15° aufwärts gefräst
Wide Jaw Punch large
15° up milled

Breitmaulstanze mittel
15° aufwärts gefräst
Wide Jaw Punch medium
15° up milled

Breitmaulstanze klein
15° aufwärts gefräst
Wide Jaw Punch small
15° up milled

Breitmaulstanze klein
45° aufwärts gefräst
Wide Jaw Punch small
45° up milled

	Ø mm	Stanzung Bite mm	gerade <i>straight</i>	30° rechts <i>30° right</i>	30° links <i>30° left</i>
	3,5	5,0 X 4,5	HXX-351-50	HXX-352-50	HXX-353-50
	3,5	5,0 X 3,5	HXX-351-51	HXX-352-51	HXX-353-51
	3,5	6,0 X 2,5	HXX-351-52	HXX-352-52	HXX-353-52
	3,5	6,0 X 2,0	HXX-351-53	-	-

45° Hakenschere
45° *Hook Scissors*

45° Stanze mit Schaufel
45° *Punch with Scoop*

45° Stanze stumpf
45° *Punch blunt*

90° Stanze mit Schaufel
90° *Punch with Scoop*

90° Stanze stumpf
90° *Punch blunt*

	Ø mm	Stanzung Bite mm	rechts abgewinkelt <i>right angled</i>	links abgewinkelt <i>left angled</i>
	3,5	-	HXX-350-12	HXX-351-12
	3,5	4,5 X 1,6	HXX-350-28	HXX-351-28
	3,5	4,5 X 1,6	HXX-350-30	HXX-351-30
	3,5	4,5 X 1,6	HXX-350-32	HXX-351-32
	3,5	4,5 X 1,6	HXX-350-34	HXX-351-34

H67-XXX-XX
Fig. 5



H68-XXX-XX
Fig. 6



45° rechts 45° right



45° links 45° left



7° auf 7° up



7° ab 7° down



15° auf 15° up



15° ab 15° down

HXX-354-50

HXX-355-50

HXX-356-50

HXX-357-50

HXX-358-50

HXX-359-50

HXX-354-51

HXX-355-51

HXX-356-51

HXX-357-51

HXX-358-51

HXX-359-51

HXX-354-52

HXX-355-52

HXX-356-52

HXX-357-52

HXX-358-52

HXX-359-52

-

-

-

-

-

-

90° Breitmaulstanze
mittel

90° Wide Jaw Punch
medium

90° Breitmaulstanze
klein

90° Wide Jaw Punch
small



Ø mm

Stanzung
Bite mm

rechts abgewinkelt
right angled

links abgewinkelt
left angled

3,5

7,0 X 3,0

HXX-350-13

HXX-351-13

3,5

7,0 X 1,8

HXX-350-14

HXX-351-14

H62-XXX-XX
Fig. 1



H60-XXX-XX
Fig. 3



H61-XXX-XX
Fig. 4



Scherenstanze
Scissors Punch

	Ø mm	Stanzung Bite mm	gerade <i>straight</i>	30° rechts <i>30° right</i>	30° links <i>30° left</i>
--	------	---------------------	---------------------------	--------------------------------	------------------------------

Scherenstanze
15° aufwärts gefräst
Scissors Punch
15° up milled

	3,5	5,0 X 0,8	HXX-351-55	HXX-352-55	HXX-353-55
--	-----	-----------	-------------------	-------------------	-------------------

Stanze Retrograd
Schnitt links
Punch Retrograde
Cut left

	3,5	5,0 X 0,8	HXX-351-56	HXX-352-56	HXX-353-56
--	-----	-----------	-------------------	-------------------	-------------------

Stanze Retrograd
Schnitt rechts
Punch Retrograde
Cut right

	3,5	4,0 X 2,5	HXX-351-57	-	-
--	-----	-----------	-------------------	---	---

	3,5	4,0 X 2,5	HXX-351-58	-	-
--	-----	-----------	-------------------	---	---

Fasszange
Grasping Forceps

	Ø mm	ohne Sperre <i>without ratchet</i>
--	------	---------------------------------------

Fasszange 1 X 2 Zähne
Grasping Forceps
1 X 2 Teeth

	2,7	HXX-270-40
	3,5	HXX-350-40

Fasszange 1 X 2 Zähne
Grasping Forceps
1 X 2 Teeth

	3,5	HXX-350-46
--	-----	-------------------

Fass- und Biopsiezange
Grasping and Biopsy
Forceps

	3,5	HXX-350-42
--	-----	-------------------

Biopsie-Löffel-Zange
Biopsy Spoon Forceps

	3,5	HXX-350-44
--	-----	-------------------

Bulldog Fasszange
1 X 2 Teeth

	3,5	HXX-350-43
--	-----	-------------------

Bulldog Grasping Forceps
1 X 2 Teeth

	3,5	HXX-350-47
--	-----	-------------------

H67-XXX-XX
Fig. 5



H68-XXX-XX
Fig. 6

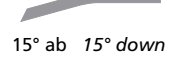
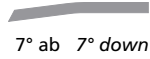
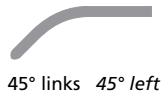
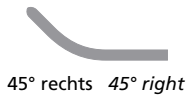

HXX-354-55

HXX-355-55

HXX-356-55

HXX-357-55

HXX-358-55

HXX-359-55

HXX-354-56

HXX-355-56

HXX-356-56

HXX-357-56

HXX-358-56

HXX-359-56

-

-

-

-

-

-

-

-

-

-

-

-

Fasszange
Grasping Forceps

Fasszange 1 X 2 Zähne
*Grasping Forceps
1 X 2 Teeth*

Fasszange 1 X 2 Zähne
*Grasping Forceps
1 X 2 Teeth*

Fass- und Biopsiezange
*Grasping and Biopsy
Forceps*

Biopsie-Löffel-Zange
Biopsy Spoon Forceps

Bulldog Fasszange
1 X 2 Teeth

*Bulldog Grasping Forceps
1 X 2 Teeth*



Ø mm

mit Sperre *with ratchet*

2,7

H64-270-40

3,5

H64-350-40

3,5

H64-350-46

3,5

H64-350-42

3,5

H64-350-44

3,5

H64-350-43

3,5

H64-350-47

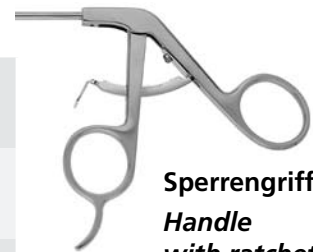

**Sperregriff
Handle
with ratchet
H64-XXX-XX
Fig. 2**

Arthroskopie-Stanzen
drehbar und zerlegbar,
verschiedene Modelle auf Anfrage

Arthroscopy punches
rotatable and detachable,
different models on request

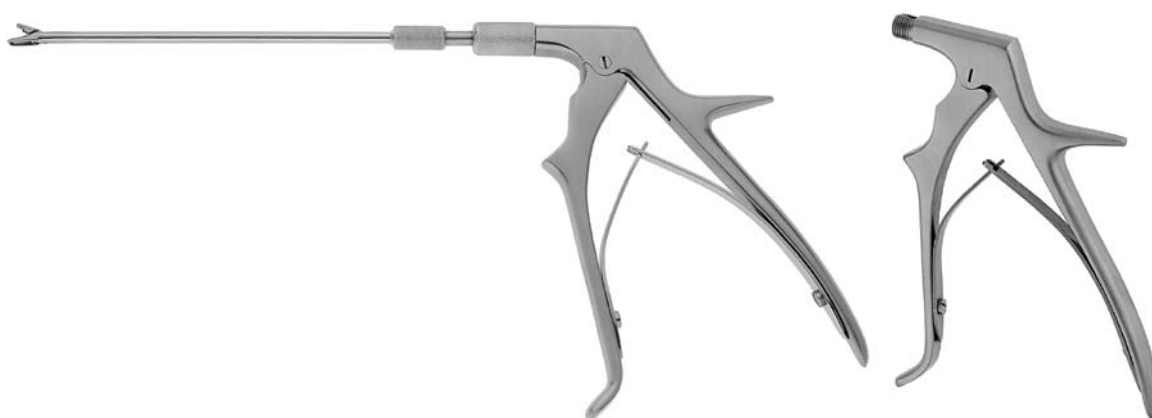

Saugstanze
Suction-Punch

Saugstanze mit 2 auswechselbaren Schneidrohren
Suction-Punch with 2 additional cutting tube-blades

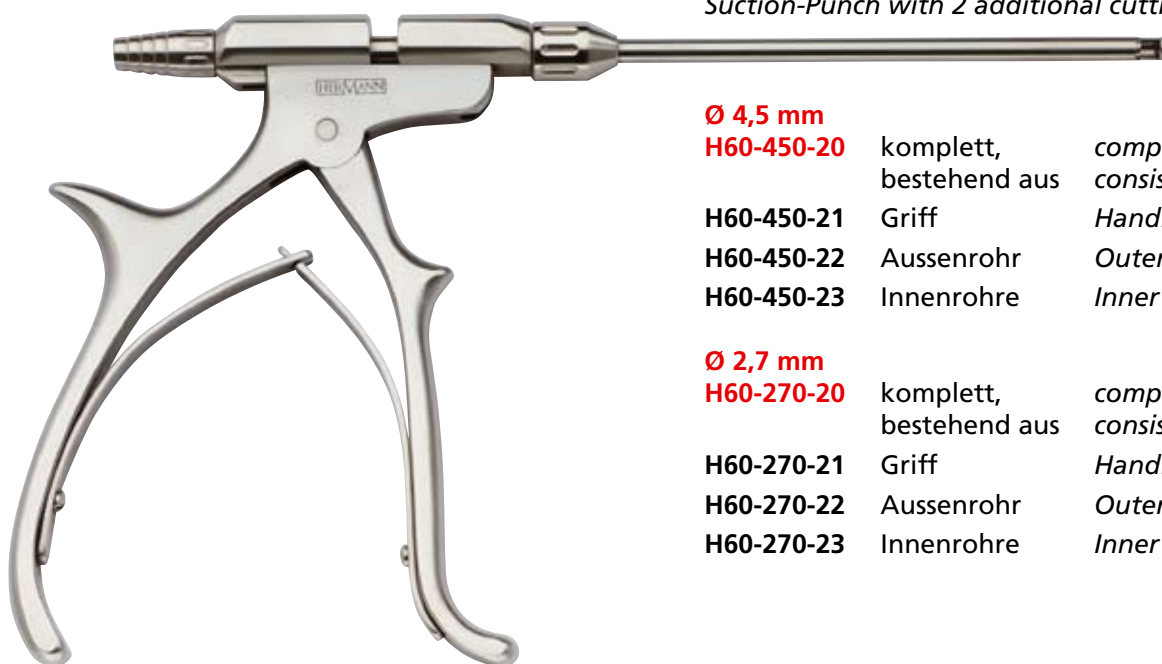

Ø 4,5 mm		
H60-450-20	komplett, bestehend aus	<i>complete, consisting of</i>
H60-450-21	Griff	<i>Handle</i>
H60-450-22	Aussenrohr	<i>Outer sheath</i>
H60-450-23	Innenrohre	<i>Inner sheaths</i>
Ø 2,7 mm		
H60-270-20	komplett, bestehend aus	<i>complete, consisting of</i>
H60-270-21	Griff	<i>Handle</i>
H60-270-22	Aussenrohr	<i>Outer sheath</i>
H60-270-23	Innenrohre	<i>Inner sheaths</i>

gerade *straight*

rechts gebogen *curved right*

links gebogen *curved left*

Fasszange, 1 X 2 Zähne
Grasping Forceps, 1 X 2 teeth

H55-001-46

H55-003-46

H55-002-46



gerade *straight*

Fasszange, 1 X 2 Zähne
Grasping Forceps, 1 X 2 teeth

H60-001-48



Griff für Einsätze
mit Arretierung
*Handle for Inserts
with adjustment*

H66-0000-01

Griff für Einsätze,
variabel
*Handle for Inserts,
variable*

H66-0000

















Aufsätze
für Griff
H66-0000-01

*Inserts
for handle
H66-0000-01*

















Aufsätze
für Griff
H66-0000

*Inserts
for handle
H66-0000*















Hakensonde, spitz <i>Hook Probe, pointed</i>		H66-0200-01	H66-0200
Hakensonde, graduiert <i>Hook Probe, graduated</i>		2,5 mm H66-0425-01 3,5 mm H66-0435-01	H66-0425 H66-0435
Skalpellmesser <i>Scalpel Knife</i>		H66-1000-01	H66-1000
Bananamesser, glatt <i>Banana Knife, smooth</i>		H66-1100-01	H66-1100
Bananamesser, gezahnt <i>Banana Knife, serrated</i>		H66-1200-01	H66-1200
Hakenmesser, 90° <i>Hook Knife, 90°</i>		3 mm H66-1390-01	H66-1390
Messer, 45°, retrograd <i>Knife, 45°, retrograd</i>		5 mm H66-1445-01	H66-1445
Sichelmesser <i>Sickle Knife</i>		H66-1500-01	H66-1500
Bajonettmesser <i>Bajonet Knife</i>		H66-1600-01	H66-1600
Messer, gezahnt, gerade <i>Knife, serrated, straight</i>		3 mm H66-1700-01	H66-1700
Messer, gezahnt, 30° gebogen <i>Knife, serrated, 30° curved</i>		links <i>left</i> H66-1830-01 rechts <i>right</i> H66-1930-01	H66-1830 H66-1930
Meniskotom, gerade Schneide <i>Meniscotome, straight edge</i>		3 mm H66-2030-01 5 mm H66-2050-01	H66-2030 H66-2050
Meniskotom, runde Schneide <i>Meniscotome, round edge</i>		7 mm H66-2070-01	H66-2070
Ringkürette, 30° <i>Ring Curette, 30°</i>		Ø 3 mm H66-3030-01 Ø 7 mm H66-3070-01	H66-3030 H66-3070
Löffel, 15° <i>Spoon, 15°</i>		Ø 3 mm H66-4030-01	H66-4030
Knorpelfeile, fein <i>Cartilage rasp, fine</i>		H66-4050-01	H66-4050
Knorpelfeile, grob <i>Cartilage rasp, rough</i>		H66-4060-01	H66-4060

**Einteilige Instrumente,
Dreiecksgriff**
*One-Piece Instruments
Handle triangular*

Hakensonde, spitz <i>Hook Probe, pointed</i>			H69-0200
Hakensonde, graduert <i>Hook Probe, graduated</i>		3 mm	H69-0425
		5 mm	H69-0435
Skalpellmesser <i>Scalpel Knife</i>			H69-1000
Bananamesser, glatt <i>Banana Knife, smooth</i>			H69-1100
Bananamesser, gezahnt <i>Banana Knife, serrated</i>			H69-1200
Hakenmesser, 90° <i>Hook Knife, 90°</i>		3 mm	H69-1390
Messer, 45°, retrograd <i>Knife, 45°, retrograd</i>		5 mm	H69-1445
Sichelmesser <i>Sickle Knife</i>			H69-1500
Bajonettmesser <i>Bajonet Knife</i>			H69-1600
Messer, gezahnt, gerade <i>Knife, serrated, straight</i>		3 mm	H69-1700
Messer, gezahnt, 30° gebogen <i>Knife, serrated, 30° curved</i>		links <i>left</i>	H69-1830
		rechts <i>right</i>	H69-1930
Meniskotom, gerade Schneide <i>Meniscotome, straight edge</i>		3 mm	H69-2030
		5 mm	H69-2050
Meniskotom, runde Schneide <i>Meniscotome, round edge</i>		7 mm	H69-2070
Ringkürette, 30° <i>Ring Curette, 30°</i>		Ø 3 mm	H69-3030
		Ø 7 mm	H69-3070
Löffel, 15° <i>Spoon, 15°</i>		Ø 3 mm	H69-4030
Knorpelfeile, fein <i>Cartilage rasp, fine</i>			H69-4050
Knorpelfeile, grob <i>Cartilage rasp, rough</i>			H69-4060



Einteilige Instrumente
One-Piece Instruments

Hakensonde <i>Hook Probe</i>		4 mm	H65-0540
Skalpelmesser <i>Scalpel Knife</i>			H65-1000
Bananamesser, glatt <i>Banana Knife, smooth</i>			H65-1100
Bananamesser, gezahnt <i>Banana Knife, serrated</i>			H65-1200
Hakenmesser, 90° <i>Hook Knife, 90°</i>			H65-1390
Messer, 45° <i>Knife, 45°</i>			H65-1445
Messer, gezahnt, gerade <i>Knife, serrated, straight</i>			H65-1700
Meniskotom, gerade Schneide <i>Meniscotome, straight edge</i>		3 mm	H65-2030
		5 mm	H65-2050
Ringkürette, 30° <i>Ring Curette, 30°</i>		Ø 3 mm	H65-3030
Löffel, 15° <i>Spoon, 15°</i>		Ø 3 mm	H65-4030
Knorpelfeile, fein <i>Cartilage rasp, fine</i>			H65-4050
Knorpelfeile, grob <i>Cartilage rasp, rough</i>			H65-4060



Interferenz Schrauben
Interference Screws



**Interferenz Schrauben,
Gewinde tief, 2-gängig**
*Interference Screws, deep
thread, double action*



**Interferenz Schrauben,
Gewinde normal**
*Interference Screws,
normal thread*

Ø mm	Länge length mm	
7	20	H24-70320
7	25	H24-70325
7	30	H24-70330
8	20	H24-80320
8	25	H24-80325
8	30	H24-80330
9	20	H24-90320
9	25	H24-90325
9	30	H24-90330
10	20	H24-10320
10	25	H24-10325
10	30	H24-10330

Ø mm	Länge length mm	
7	20	H25-70320
7	25	H25-70325
7	30	H25-70330
8	20	H25-80320
8	25	H25-80325
8	30	H25-80330
9	20	H25-90320
9	25	H25-90325
9	30	H25-90330
10	20	H25-10320
10	25	H25-10325
10	30	H25-10330

Schraubendreher starr
Screwdriver fixed

H25-00000



Arthroskopieschäfte Arthroscopy Shafts

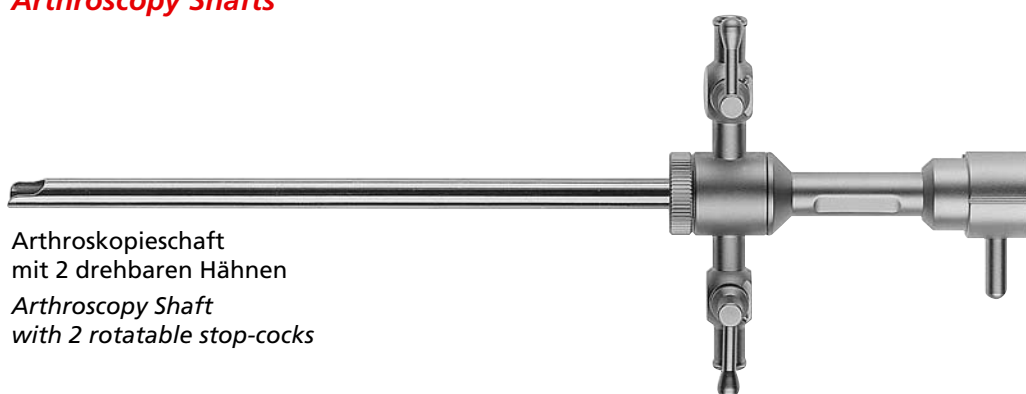

Arthroskopieschaft
mit 2 drehbaren Hähnen
*Arthroscopy Shaft
with 2 rotatable stop-cocks*

Optik Optic Ø mm	Optiklänge Scope length mm	Universal	30°
2,7	110	H80-033-01	H80-033-0130
2,7	175	H80-033-00	H80-033-0030
2,7	187,5	H80-033-02	H80-033-0230
4,0	175	H80-043-00	H80-043-0030
4,0 high flow	175	H80-053-00	H80-053-0030



Arthroskopieschaft
mit 1 drehbaren Hahn
*Arthroscopy Shaft
with 1 rotatable stop-cock*

Optik Optic Ø mm	Optiklänge Scope length mm	Universal	30°
2,7	175	H80-031-00	H80-031-0030
2,7	187,5	H80-031-02	H80-031-0230
4,0	175	H80-041-00	H80-041-0030
4,0 high flow	175	H80-051-00	H80-051-0030

**Trokare und Obturatoren
für Arthroskopieschäfte**
*Trocars and Obturators
for Arthroscopy Shafts*

Trokar dreikant
Trocar pyramidal



für Optik <i>for scope</i> Ø mm	für Optik Länge <i>for scope length</i> mm	
2,7	110	H80-127-30
2,7	175	H80-027-30
2,7	187,5	H80-227-30
4,0	175	H80-040-30
4,0 high flow	175	H80-050-30

Obturator stumpf
Obturator blunt



für Optik <i>for scope</i> Ø mm	für Optik Länge <i>for scope length</i> mm	
2,7	110	H80-127-31
2,7	175	H80-027-31
2,7	187,5	H80-227-31
4,0	175	H80-040-31
4,0 high flow	175	H80-050-31

Obturator konisch
Obturator conical



für Optik <i>for scope</i> Ø mm	für Optik Länge <i>for scope length</i> mm	
2,7	175	H80-027-32
2,7	187,5	H80-227-32
4	175	H80-040-32
4,0 high flow	175	H80-050-32



Spülkanüle, Hahn,
Luer-Lock-Anschluß
*Suction Canula, stopcock,
Luer-Lock connection*

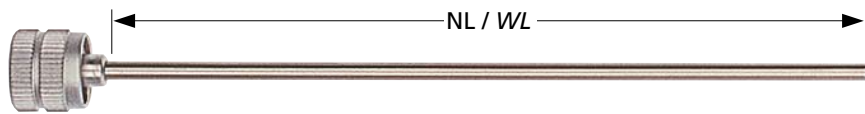

Obturator stumpf
Obturator blunt

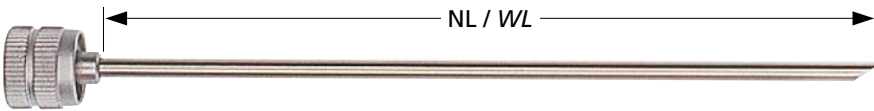

Trokar
Trocar

Ø mm komplett (nur als komplettes Set erhältlich)
complete (only available as complete set)

NL mm
WL mm

Ø mm	komplett (nur als komplettes Set erhältlich) <i>complete (only available as complete set)</i>	bestehend aus <i>consisting of</i>		NL mm WL mm
3,2	H80-307-31	bestehend aus <i>consisting of</i>	Spülkanüle <i>Suction Canula</i>	70
			Obturator <i>Obturator</i>	92
			Trokar <i>Trocar</i>	94,5
4,5	H80-407-31	bestehend aus <i>consisting of</i>	Spülkanüle <i>Suction Canula</i>	70
			Obturator <i>Obturator</i>	93
			Trokar <i>Trocar</i>	97,5

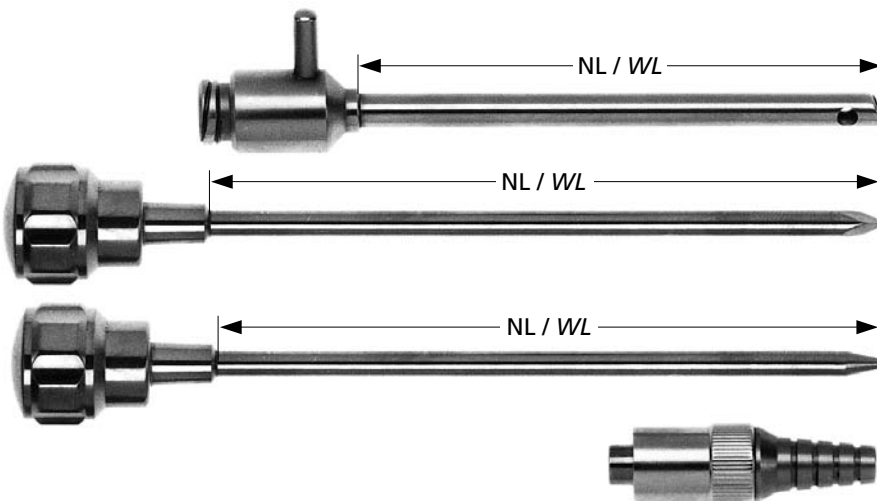

Inflowkanüle komplett
Inflow Canula complete

Ø mm komplett (nur als komplettes Set erhältlich)
complete (only available as complete set)

NL mm
WL mm

Ø mm	komplett (nur als komplettes Set erhältlich) <i>complete (only available as complete set)</i>	bestehend aus <i>consisting of</i>		NL mm WL mm
4,5	H80-408-00	bestehend aus <i>consisting of</i>	Schaft allein <i>Shaft only</i>	83
			Trokar dreikant <i>Trocar pyramidal</i>	107,5
			Trokar stumpf <i>Trocar blunt</i>	107
			Adapter <i>Adapter</i>	

Arthroskopieschäfte
Arthroscopy Shafts

Arthroskopieschaft mit 2 drehbaren
Hähnen, Dyonics kompatibel
*Arthroscopy Shaft with 2 rotatable
stop-cocks, Dyonics compatible*

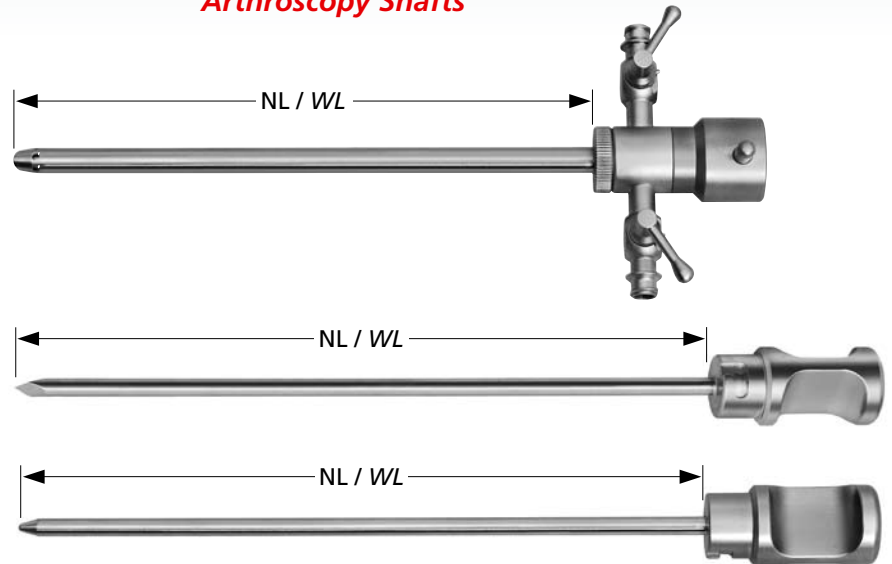

	Optik <i>Optic</i> Ø mm	NL mm WL mm	
Schaft 30° <i>Shaft 30°</i>	4	138	H80-040-138
Trokar dreikant <i>Trocar pyramidal</i>		165	H80-140-165
Obturator konisch <i>Obturator conical</i>		164	H80-240-164

Arthroskopieschaft mit 2 drehbaren
Hähnen, Stryker kompatibel
*Arthroscopy Shaft with 2 rotatable
stop-cocks, Stryker compatible*

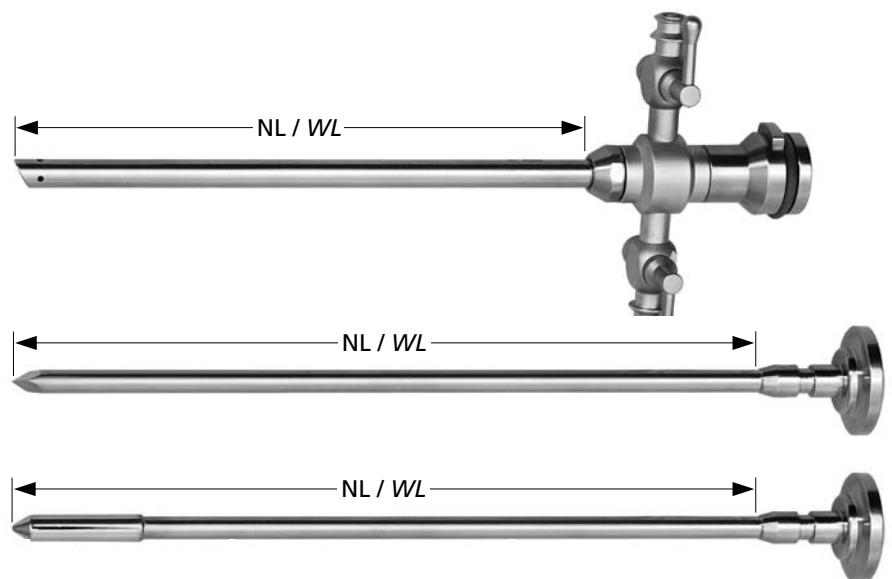

	Optik <i>Optic</i> Ø mm	NL mm WL mm	
Schaft 30° <i>Shaft 30°</i>	4	115,5	H80-040-1155
Trokar dreikant <i>Trocar pyramidal</i>		148,2	H80-140-1482
Obturator konisch <i>Obturator conical</i>		147,5	H80-240-1475

NL = Nutzlänge
WL = Working length

Arthroskope, HD
autoklavierbar

Arthroscopes, HD
autoclavable

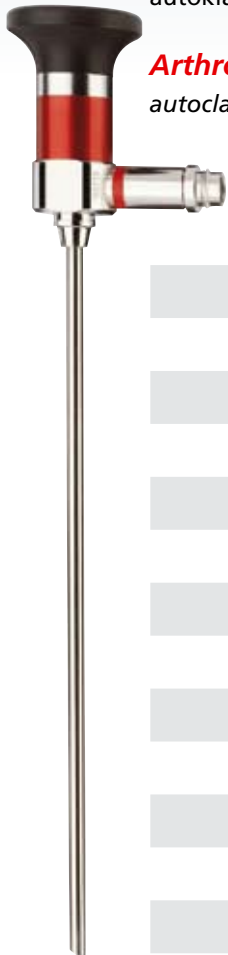

Ø mm	Blickrichtung Direction of view	Länge length mm	
2,7	0°	110	H84-027-000
2,7	30°	110	H84-027-030
2,7	70°	110	H84-027-070
2,7	0°	175	H84-127-000
2,7	30°	175	H84-127-030
2,7	70°	175	H84-127-070
2,7	0°	187,5	H84-227-000
2,7	30°	187,5	H84-227-030
2,7	70°	187,5	H84-227-070
4,0	0°	175	H84-040-000
4,0	30°	175	H84-040-030
4,0	45°	175	H84-040-045
4,0	70°	175	H84-040-070

Minioptiken auf Anfrage lieferbar
Miniscopes deliverable on request



Lichtleitkabel
Autoklavierbar, hochflexibel und zugfest
Cold Light Cable
Autoclavable, high flexibility and tensile strength

Ø mm	Länge Length mm	
3,5	1800	H91-180-035
3,5	2300	H91-230-035
3,5	3000	H91-300-035
4,8	1800	H91-180-045
4,8	2300	H91-230-045
4,8	3000	H91-300-045

Sofern nicht anders vermerkt, liefern wir mit STORZ-Anschlüssen. Lichtleitkabel auch für Xenon-Lampen 300 W geeignet.

If not stated differently we supply with STORZ connections. Light guides as well appropriate for Xenon lamps 300 W.

Arthroskopie-Elektroden
Arthroscopic electrodes

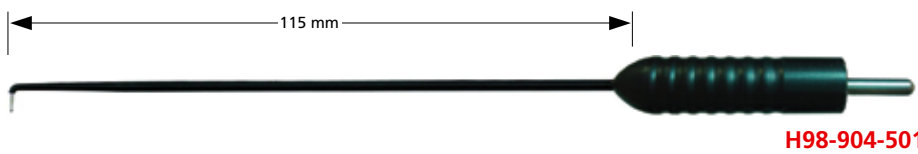

H98-904-501

Nadel	<i>Needle</i>
90° abgewinkelt,	<i>angled 90°,</i>
1,5 mm,	<i>1,5 mm,</i>
Länge 115 mm,	<i>length 115 mm,</i>
Ø 0,6mm	<i>Ø 0.6 mm</i>



H98-904-502

Nadel	<i>Needle</i>
90° abgewinkelt,	<i>angled 90°,</i>
4 mm,	<i>4 mm,</i>
Länge 115 mm,	<i>length 115 mm,</i>
Ø 0,6mm	<i>Ø 0.6 mm</i>



H98-904-503

Messer	<i>Knife</i>
45° abgewinkelt,	<i>angled 45°,</i>
4 mm,	<i>4 mm,</i>
Länge 115mm	<i>length 115mm</i>



H98-904-505

Tastelektrode	<i>Keying electrode</i>
90° abgewinkelt,	<i>angled 90°,</i>
4 mm,	<i>4 mm,</i>
Länge 115 mm,	<i>length 115 mm,</i>
Ø 1,5 mm	<i>Ø 1,5 mm</i>



H98-904-506

Kugelelektrode,	<i>Ball electrode,</i>
Länge 115 mm,	<i>length 115 mm,</i>
Ø 3 mm	<i>Ø 3 mm</i>

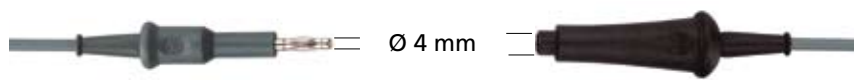

Ø 4 mm

Anschlußkabel	3 m	H98-903-130
Connecting cable	5 m	H98-903-150

Stecker Geräteseite,
passend für Hermann-,
Martin-, Berchtold-Geräte
*Plug, generator side for
Hermann-, Martin-,
Berchtold-generators*

Stecker Instrumentenseite,
6-kant
*Plug, instrument side,
hexagon coding*

Artikel-Nummern Verzeichnis

Order Number Index

Art. Nr. art.-no.	Seite page	Art. Nr. art.-no.	Seite page	Art. Nr. art.-no.	Seite page	Art. Nr. art.-no.	Seite page	Art. Nr. art.-no.	Seite page	Art. Nr. art.-no.	Seite page
H24-10320	17	H60-274-10	7	H60-351-32	8	H60-354-38	7	H60-358-10	7	H61-274-36	7
H24-10325	17	H60-274-21	7	H60-351-34	8	H60-354-39	7	H60-358-21	7	H61-275-10	7
H24-10330	17	H60-274-23	7	H60-351-36	6	H60-354-50	9	H60-358-23	7	H61-275-21	7
H24-70320	17	H60-274-36	7	H60-351-37	6	H60-354-51	9	H60-358-24	7	H61-275-23	7
H24-70325	17	H60-275-10	7	H60-351-38	6	H60-354-52	9	H60-358-36	7	H61-275-36	7
H24-70330	17	H60-275-21	7	H60-351-39	6	H60-354-55	11	H60-358-37	7	H61-276-10	7
H24-80320	17	H60-275-23	7	H60-351-50	8	H60-354-56	11	H60-358-38	7	H61-276-21	7
H24-80325	17	H60-275-36	7	H60-351-51	8	H60-355-10	7	H60-358-39	7	H61-276-23	7
H24-80330	17	H60-276-10	7	H60-351-52	8	H60-355-21	7	H60-358-50	9	H61-276-36	7
H24-90320	17	H60-276-21	7	H60-351-53	8	H60-355-23	7	H60-358-51	9	H61-277-10	7
H24-90325	17	H60-276-23	7	H60-351-55	10	H60-355-24	7	H60-358-52	9	H61-277-21	7
H24-90330	17	H60-276-36	7	H60-351-56	10	H60-355-36	7	H60-358-55	11	H61-277-23	7
H25-00000	17	H60-277-10	7	H60-351-57	10	H60-355-37	7	H60-358-56	11	H61-277-36	7
H25-10320	17	H60-277-21	7	H60-351-58	10	H60-355-38	7	H60-359-10	7	H61-278-10	7
H25-10325	17	H60-277-23	7	H60-352-10	6	H60-355-39	7	H60-359-21	7	H61-278-21	7
H25-10330	17	H60-277-36	7	H60-352-21	6	H60-355-50	9	H60-359-23	7	H61-278-23	7
H25-70320	17	H60-278-10	7	H60-352-23	6	H60-355-51	9	H60-359-24	7	H61-278-36	7
H25-70325	17	H60-278-21	7	H60-352-24	6	H60-355-52	9	H60-359-36	7	H61-279-10	7
H25-70330	17	H60-278-23	7	H60-352-36	6	H60-355-55	11	H60-359-37	7	H61-279-21	7
H25-80320	17	H60-278-36		H60-352-37	6	H60-355-56	11	H60-359-38	7	H61-279-23	7
H25-80325	17	H60-279-10	7	H60-352-38	6	H60-356-10	7	H60-359-39	7	H61-279-36	7
H25-80330	17	H60-279-21	7	H60-352-39	6	H60-356-21	7	H60-359-50	9	H61-350-12	8
H25-90320	17	H60-279-23	7	H60-352-50	8	H60-356-23	7	H60-359-51	9	H61-350-13	9
H25-90325	17	H60-279-36	7	H60-352-51	8	H60-356-24	7	H60-359-52	9	H61-350-14	9
H25-90330	17	H60-350-12	8	H60-352-52	8	H60-356-36	7	H60-359-55	11	H61-350-28	8
H55-001-46	13	H60-350-13	9	H60-352-55	10	H60-356-37	7	H60-359-56	11	H61-350-30	8
H55-002-46	13	H60-350-14	9	H60-352-56	10	H60-356-38	7	H60-450-20	12	H61-350-32	8
H55-003-46	13	H60-350-28	8	H60-353-10	6	H60-356-39	7	H60-450-21	12	H61-350-34	8
H60-001-48	13	H60-350-30	8	H60-353-21	6	H60-356-50	9	H60-450-22	12	H61-350-40	10
H60-270-20	12	H60-350-32	8	H60-353-23	6	H60-356-51	9	H60-450-23	12	H61-350-42	10
H60-270-21	12	H60-350-34	8	H60-353-24	6	H60-356-52	9	H61-270-40	10	H61-350-43	10
H60-270-22	12	H60-350-40	10	H60-353-36	6	H60-356-55	11	H61-271-10	6	H61-350-44	10
H60-270-23	12	H60-350-42	10	H60-353-37	6	H60-356-56	11	H61-271-21	6	H61-350-46	10
H60-270-40	10	H60-350-43	10	H60-353-38	6	H60-357-10	7	H61-271-23	6	H61-350-47	10
H60-271-10	6	H60-350-44	10	H60-353-39	6	H60-357-21	7	H61-271-36	6	H61-351-10	6
H60-271-21	6	H60-350-46	10	H60-353-50	8	H60-357-23	7	H61-272-10	6	H61-351-12	8
H60-271-23	6	H60-350-47	10	H60-353-51	8	H60-357-24	7	H61-272-21	6	H61-351-13	9
H60-271-36	6	H60-351-10	6	H60-353-52	8	H60-357-36	7	H61-272-23	6	H61-351-14	9
H60-272-10	6	H60-351-12	8	H60-353-55	10	H60-357-37	7	H61-272-36	6	H61-351-21	6
H60-272-21	6	H60-351-13	9	H60-353-56	10	H60-357-38	7	H61-273-10	6	H61-351-23	6
H60-272-23	6	H60-351-14	9	H60-354-10	7	H60-357-39	7	H61-273-21	6	H61-351-24	6
H60-272-36	6	H60-351-21	6	H60-354-21	7	H60-357-50	9	H61-273-23	6	H61-351-28	8
H60-273-10	6	H60-351-23	6	H60-354-23	7	H60-357-51	9	H61-273-36	6	H61-351-30	8
H60-273-21	6	H60-351-24	6	H60-354-24	7	H60-357-52	9	H61-274-10	7	H61-351-32	8
H60-273-23	6	H60-351-28	8	H60-354-36	7	H60-357-55	11	H61-274-21	7	H61-351-34	8
H60-273-36	6	H60-351-30	8	H60-354-37	7	H60-357-56	11	H61-274-23	7	H61-351-36	6

Art. Nr. art.-no.	Seite page	Art. Nr. art.-no.	Seite page	Art. Nr. art.-no.	Seite page	Art. Nr. art.-no.	Seite page	Art. Nr. art.-no.	Seite page	Art. Nr. art.-no.	Seite page
H61-351-37	6	H61-354-51	9	H61-358-24	7	H62-276-23	7	H62-351-55	10	H62-355-24	7
H61-351-38	6	H61-354-52	9	H61-358-36	7	H62-276-36	7	H62-351-56	10	H62-355-36	7
H61-351-39	6	H61-354-55	11	H61-358-37	7	H62-277-10	7	H62-351-57	10	H62-355-37	7
H61-351-50	8	H61-354-56	11	H61-358-38	7	H62-277-21	7	H62-351-58	10	H62-355-38	7
H61-351-51	8	H61-355-10	7	H61-358-39	7	H62-277-23	7	H62-352-10	6	H62-355-39	7
H61-351-52	8	H61-355-21	7	H61-358-50	9	H62-277-36	7	H62-352-21	6	H62-355-50	9
H61-351-53	8	H61-355-23	7	H61-358-51	9	H62-278-10	7	H62-352-23	6	H62-355-51	9
H61-351-55	10	H61-355-24	7	H61-358-52	9	H62-278-21	7	H62-352-24	6	H62-355-52	9
H61-351-56	10	H61-355-36	7	H61-358-55	11	H62-278-23	7	H62-352-36	6	H62-355-55	11
H61-351-57	10	H61-355-37	7	H61-358-56	11	H62-278-36	7	H62-352-37	6	H62-355-56	11
H61-351-58	10	H61-355-38	7	H61-359-10	7	H62-279-10	7	H62-352-38	6	H62-356-10	7
H61-352-10	6	H61-355-39	7	H61-359-21	7	H62-279-21	7	H62-352-39	6	H62-356-21	7
H61-352-21	6	H61-355-50	9	H61-359-23	7	H62-279-23	7	H62-352-50	8	H62-356-23	7
H61-352-23	6	H61-355-51	9	H61-359-24	7	H62-279-36	7	H62-352-51	8	H62-356-24	7
H61-352-24	6	H61-355-52	9	H61-359-36	7	H62-350-12	8	H62-352-52	8	H62-356-36	7
H61-352-36	6	H61-355-55	11	H61-359-37	7	H62-350-13	9	H62-352-55	10	H62-356-37	7
H61-352-37	6	H61-355-56	11	H61-359-38	7	H62-350-14	9	H62-352-56	10	H62-356-38	7
H61-352-38	6	H61-356-10	7	H61-359-39	7	H62-350-28	8	H62-353-10	6	H62-356-39	7
H61-352-39	6	H61-356-21	7	H61-359-50	9	H62-350-30	8	H62-353-21	6	H62-356-50	9
H61-352-50	8	H61-356-23	7	H61-359-51	9	H62-350-32	8	H62-353-23	6	H62-356-51	9
H61-352-51	8	H61-356-24	7	H61-359-52	9	H62-350-34	8	H62-353-24	6	H62-356-52	9
H61-352-52	8	H61-356-36	7	H61-359-55	11	H62-350-40	10	H62-353-36	6	H62-356-55	11
H61-352-55	10	H61-356-37	7	H61-359-56	11	H62-350-42	10	H62-353-37	6	H62-356-56	11
H61-352-56	10	H61-356-38	7	H62-270-40	10	H62-350-43	10	H62-353-38	6	H62-357-10	7
H61-353-10	6	H61-356-39	7	H62-271-10	6	H62-350-44	10	H62-353-39	6	H62-357-21	7
H61-353-21	6	H61-356-50	9	H62-271-21	6	H62-350-46	10	H62-353-50	8	H62-357-23	7
H61-353-23	6	H61-356-51	9	H62-271-23	6	H62-350-47	10	H62-353-51	8	H62-357-24	7
H61-353-24	6	H61-356-52	9	H62-271-36	6	H62-351-10	6	H62-353-52	8	H62-357-36	7
H61-353-36	6	H61-356-55	11	H62-272-10	6	H62-351-12	8	H62-353-55	10	H62-357-37	7
H61-353-37	6	H61-356-56	11	H62-272-21	6	H62-351-13	9	H62-353-56	10	H62-357-38	7
H61-353-38	6	H61-357-10	7	H62-272-23	6	H62-351-14	9	H62-354-10	7	H62-357-39	7
H61-353-39	6	H61-357-21	7	H62-272-36	6	H62-351-21	6	H62-354-21	7	H62-357-50	9
H61-353-50	8	H61-357-23	7	H62-273-10	6	H62-351-23	6	H62-354-23	7	H62-357-51	9
H61-353-51	8	H61-357-24	7	H62-273-21	6	H62-351-24	6	H62-354-24	7	H62-357-52	9
H61-353-52	8	H61-357-36	7	H62-273-23	6	H62-351-28	8	H62-354-36	7	H62-357-55	11
H61-353-55	10	H61-357-37	7	H62-273-36	6	H62-351-30	8	H62-354-37	7	H62-357-56	11
H61-353-56	10	H61-357-38	7	H62-274-10	7	H62-351-32	8	H62-354-38	7	H62-358-10	7
H61-354-10	7	H61-357-39	7	H62-274-21	7	H62-351-34	8	H62-354-39	7	H62-358-21	7
H61-354-21	7	H61-357-50	9	H62-274-23	7	H62-351-36	6	H62-354-50	9	H62-358-23	7
H61-354-23	7	H61-357-51	9	H62-274-36	7	H62-351-37	6	H62-354-51	9	H62-358-24	7
H61-354-24	7	H61-357-52	9	H62-275-10	7	H62-351-38	6	H62-354-52	9	H62-358-36	7
H61-354-36	7	H61-357-55	11	H62-275-21	7	H62-351-39	6	H62-354-55	11	H62-358-37	7
H61-354-37	7	H61-357-56	11	H62-275-23	7	H62-351-50	8	H62-354-56	11	H62-358-38	7
H61-354-38	7	H61-358-10	7	H62-275-36	7	H62-351-51	8	H62-355-10	7	H62-358-39	7
H61-354-39	7	H61-358-21	7	H62-276-10	7	H62-351-52	8	H62-355-21	7	H62-358-50	9
H61-354-50	9	H61-358-23	7	H62-276-21	7	H62-351-53	8	H62-355-23	7	H62-358-51	9

Artikel-Nummern Verzeichnis

Order Number Index

Art. Nr. art.-no.	Seite page	Art. Nr. art.-no.	Seite page	Art. Nr. art.-no.	Seite page	Art. Nr. art.-no.	Seite page	Art. Nr. art.-no.	Seite page	Art. Nr. art.-no.	Seite page
H62-358-52	9	H66-1000-01	14	H67-273-10	6	H67-351-14	9	H67-353-55	10	H67-357-24	7
H62-358-55	11	H66-1100	14	H67-273-21	6	H67-351-21	6	H67-353-56	10	H67-357-36	7
H62-358-56	11	H66-1100-01	14	H67-273-23	6	H67-351-23	6	H67-354-10	7	H67-357-37	7
H62-359-10	7	H66-1200	14	H67-273-36	6	H67-351-24	6	H67-354-21	7	H67-357-38	7
H62-359-21	7	H66-1200-01	14	H67-274-10	7	H67-351-28	8	H67-354-23	7	H67-357-39	7
H62-359-23	7	H66-1390	14	H67-274-21	7	H67-351-30	8	H67-354-24	7	H67-357-50	9
H62-359-24	7	H66-1390-01	14	H67-274-23	7	H67-351-32	8	H67-354-36	7	H67-357-51	9
H62-359-36	7	H66-1445	14	H67-274-36	7	H67-351-34	8	H67-354-37	7	H67-357-52	9
H62-359-37	7	H66-1445-01	14	H67-275-10	7	H67-351-36	6	H67-354-38	7	H67-357-55	11
H62-359-38	7	H66-1500	14	H67-275-21	7	H67-351-37	6	H67-354-39	7	H67-357-56	11
H62-359-39	7	H66-1500-01	14	H67-275-23	7	H67-351-38	6	H67-354-50	9	H67-358-10	7
H62-359-50	9	H66-1600	14	H67-275-36	7	H67-351-39	6	H67-354-51	9	H67-358-21	7
H62-359-51	9	H66-1600-01	14	H67-276-10	7	H67-351-50	8	H67-354-52	9	H67-358-23	7
H62-359-52	9	H66-1700	14	H67-276-21	7	H67-351-51	8	H67-354-55	11	H67-358-24	7
H62-359-55	11	H66-1700-01	14	H67-276-23	7	H67-351-52	8	H67-354-56	11	H67-358-36	7
H62-359-56	11	H66-1830	14	H67-276-36	7	H67-351-53	8	H67-355-10	7	H67-358-37	7
H63-270-40	10	H66-1830-01	14	H67-277-10	7	H67-351-55	10	H67-355-21	7	H67-358-38	7
H64-270-40	11	H66-1930	14	H67-277-21	7	H67-351-56	10	H67-355-23	7	H67-358-39	7
H64-350-40	11	H66-1930-01	14	H67-277-23	7	H67-351-57	10	H67-355-24	7	H67-358-50	9
H64-350-42	11	H66-2030	14	H67-277-36	7	H67-351-58	10	H67-355-36	7	H67-358-51	9
H64-350-43	11	H66-2030-01	14	H67-278-10	7	H67-352-10	6	H67-355-37	7	H67-358-52	9
H64-350-44	11	H66-2050	14	H67-278-21	7	H67-352-21	6	H67-355-38	7	H67-358-55	11
H64-350-46	11	H66-2050-01	14	H67-278-23	7	H67-352-23	6	H67-355-39	7	H67-358-56	11
H64-350-47	11	H66-2070	14	H67-278-36	7	H67-352-24	6	H67-355-50	9	H67-359-10	7
H65-0540	16	H66-2070-01	14	H67-279-10	7	H67-352-36	6	H67-355-51	9	H67-359-21	7
H65-1000	16	H66-3030	14	H67-279-21	7	H67-352-37	6	H67-355-52	9	H67-359-23	7
H65-1100	16	H66-3030-01	14	H67-279-23	7	H67-352-38	6	H67-355-55	11	H67-359-24	7
H65-1200	16	H66-3070	14	H67-279-36	7	H67-352-39	6	H67-355-56	11	H67-359-36	7
H65-1390	16	H66-3070-01	14	H67-350-12	8	H67-352-50	8	H67-356-10	7	H67-359-37	7
H65-1445	16	H66-4030	14	H67-350-13	9	H67-352-51	8	H67-356-21	7	H67-359-38	7
H65-1700	16	H66-4030-01	14	H67-350-14	9	H67-352-52	8	H67-356-23	7	H67-359-39	7
H65-2030	16	H66-4050-01	14	H67-350-28	8	H67-352-55	10	H67-356-24	7	H67-359-50	9
H65-2050	16	H66-4050	14	H67-350-30	8	H67-352-56	10	H67-356-36	7	H67-359-51	9
H65-3030	16	H66-4060-01	14	H67-350-32	8	H67-353-10	6	H67-356-37	7	H67-359-52	9
H65-4030	16	H66-4060	14	H67-350-34	8	H67-353-21	6	H67-356-38	7	H67-359-55	11
H66-0000	14	H67-270-40	10	H67-350-40	10	H67-353-23	6	H67-356-39	7	H67-359-56	11
H66-0000-01	14	H67-271-10	6	H67-350-42	10	H67-353-24	6	H67-356-50	9	H68-270-40	10
H66-0200	14	H67-271-21	6	H67-350-43	10	H67-353-36	6	H67-356-51	9	H68-271-10	6
H66-0200-01	14	H67-271-23	6	H67-350-44	10	H67-353-37	6	H67-356-52	9	H68-271-21	6
H66-0425	14	H67-271-36	6	H67-350-46	10	H67-353-38	6	H67-356-55	11	H68-271-23	6
H66-0425-01	14	H67-272-10	6	H67-350-47	10	H67-353-39	6	H67-356-56	11	H68-271-36	6
H66-0435	14	H67-272-21	6	H67-351-10	6	H67-353-50	8	H67-357-10	7	H68-272-10	6
H66-0435-01	14	H67-272-23	6	H67-351-12	8	H67-353-51	8	H67-357-21	7	H68-272-21	6
H66-1000	14	H67-272-36	6	H67-351-13	9	H67-353-52	8	H67-357-23	7	H68-272-23	6

Art. Nr. art.-no.	Seite page	Art. Nr. art.-no.	Seite page	Art. Nr. art.-no.	Seite page	Art. Nr. art.-no.	Seite page	Art. Nr. art.-no.	Seite page	Art. Nr. art.-no.	Seite page
H68-272-36	6	H68-351-13	9	H68-353-52	8	H68-357-23	7	H69-1445	15	H80-127-31	19
H68-273-10	6	H68-351-14	9	H68-353-55	10	H68-357-24	7	H69-1500	15	H80-140-1482	21
H68-273-21	6	H68-351-21	6	H68-353-56	10	H68-357-36	7	H69-1600	15	H80-140-165	21
H68-273-23	6	H68-351-23	6	H68-354-10	7	H68-357-37	7	H69-1700	15	H80-227-30	19
H68-273-36	6	H68-351-24	6	H68-354-21	7	H68-357-38	7	H69-1830	15	H80-227-31	19
H68-274-10	7	H68-351-28	8	H68-354-23	7	H68-357-39	7	H69-1930	15	H80-227-32	19
H68-274-21	7	H68-351-30	8	H68-354-24	7	H68-357-50	9	H69-2030	15	H80-240-1475	21
H68-274-23	7	H68-351-32	8	H68-354-36	7	H68-357-51	9	H69-2050	15	H80-240-164	21
H68-274-36	7	H68-351-34	8	H68-354-37	7	H68-357-52	9	H69-2070	15	H80-307-31	20
H68-275-10	7	H68-351-36	6	H68-354-38	7	H68-357-55	11	H69-3030	15	H80-407-31	20
H68-275-21	7	H68-351-37	6	H68-354-39	7	H68-357-56	11	H69-3070	15	H80-408-00	20
H68-275-23	7	H68-351-38	6	H68-354-50	9	H68-358-10	7	H69-4030	15	H84-027-000	22
H68-275-36	7	H68-351-39	6	H68-354-51	9	H68-358-21	7	H69-4050	15	H84-027-030	22
H68-276-10	7	H68-351-50	8	H68-354-52	9	H68-358-23	7	H69-4060	15	H84-027-070	22
H68-276-21	7	H68-351-51	8	H68-354-55	11	H68-358-24	7	H80-027-30	19	H84-040-000	22
H68-276-23	7	H68-351-52	8	H68-354-56	11	H68-358-36	7	H80-027-31	19	H84-040-030	22
H68-276-36	7	H68-351-53	8	H68-355-10	7	H68-358-37	7	H80-027-32	19	H84-040-045	22
H68-277-10	7	H68-351-55	10	H68-355-21	7	H68-358-38	7	H80-031-00	18	H84-040-070	22
H68-277-21	7	H68-351-56	10	H68-355-23	7	H68-358-39	7	H80-031-0030	18	H84-127-000	22
H68-277-23	7	H68-351-57	10	H68-355-24	7	H68-358-50	9	H80-031-02	18	H84-127-030	22
H68-277-36	7	H68-351-58	10	H68-355-36	7	H68-358-51	9	H80-031-0230	18	H84-127-070	22
H68-278-10	7	H68-352-10	6	H68-355-37	7	H68-358-52	9	H80-033-00	18	H84-227-000	22
H68-278-21	7	H68-352-21	6	H68-355-38	7	H68-358-55	11	H80-033-0030	18	H84-227-030	22
H68-278-23	7	H68-352-23	6	H68-355-39	7	H68-358-56	11	H80-033-01	18	H84-227-070	22
H68-278-36	7	H68-352-24	6	H68-355-50	9	H68-359-10	7	H80-033-0130	18	H91-180-035	22
H68-279-10	7	H68-352-36	6	H68-355-51	9	H68-359-21	7	H80-033-02	18	H91-180-045	22
H68-279-21	7	H68-352-37	6	H68-355-52	9	H68-359-23	7	H80-033-0230	18	H91-230-035	22
H68-279-23	7	H68-352-38	6	H68-355-55	11	H68-359-24	7	H80-040-1155	21	H91-230-045	22
H68-279-36	7	H68-352-39	6	H68-355-56	11	H68-359-36	7	H80-040-138	21	H91-300-035	22
H68-350-12	8	H68-352-50	8	H68-356-10	7	H68-359-37	7	H80-040-30	19	H91-300-045	22
H68-350-13	9	H68-352-51	8	H68-356-21	7	H68-359-38	7	H80-040-31	19	H98-903-130	23
H68-350-14	9	H68-352-52	8	H68-356-23	7	H68-359-39	7	H80-040-32	19	H98-903-150	23
H68-350-28	8	H68-352-55	10	H68-356-24	7	H68-359-50	9	H80-041-00	18	H98-904-501	23
H68-350-30	8	H68-352-56	10	H68-356-36	7	H68-359-51	9	H80-041-0030	18	H98-904-502	23
H68-350-32	8	H68-353-10	6	H68-356-37	7	H68-359-52	9	H80-043-00	18	H98-904-503	23
H68-350-34	8	H68-353-21	6	H68-356-38	7	H68-359-55	11	H80-043-0030	18	H98-904-505	23
H68-350-40	10	H68-353-23	6	H68-356-39	7	H68-359-56	11	H80-050-30	19	H98-904-506	23
H68-350-42	10	H68-353-24	6	H68-356-50	9	H69-0200	15	H80-050-31	19		
H68-350-43	10	H68-353-36	6	H68-356-51	9	H69-0425	15	H80-050-32	19		
H68-350-44	10	H68-353-37	6	H68-356-52	9	H69-0435	15	H80-051-00	18		
H68-350-46	10	H68-353-38	6	H68-356-55	11	H69-1000	15	H80-051-0030	18		
H68-350-47	10	H68-353-39	6	H68-356-56	11	H69-1100	15	H80-053-00	18		
H68-351-10	6	H68-353-50	8	H68-357-10	7	H69-1200	15	H80-053-0030	18		
H68-351-12	6	H68-353-51	8	H68-357-21	7	H69-1390	15	H80-127-30	19		



Hermann Medizintechnik GmbH
Württembergische Straße 26
D-78567 Fridingen/Tuttlingen
GERMANY
Tel. ++49 - 74 63 / 99 67-0
Fax ++49 - 74 63 / 99 67-50
info@hermann-medizintechnik.de
www.hermann-medizintechnik.de